

Solutions Manual to
Principles of Electronic Materials and Devices
Fourth Edition
© 2018 McGraw-Hill

CHAPTER 2

Safa Kasap
University of Saskatchewan
Canada

Check author's website for updates
<http://electronicmaterials.usask.ca>

NOTE TO INSTRUCTORS

If you are posting solutions on the internet, you must password the access and download so that *only* your students can download the solutions, no one else. Word format may be available from the author. Please check the above website. Report errors and corrections directly to the author at safa.kasap@yahoo.com

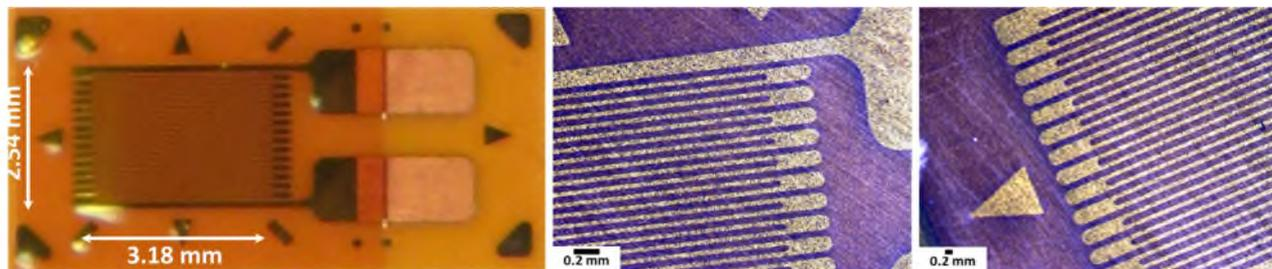

A commercial strain gauge by Micro-Measurements (Vishay Precision Group). This gauge has a maximum strain range of $\pm 5\%$. The overall resistance of the gauge is 350Ω . The gauge wire is a constantan alloy with a small thermal coefficient of resistance. The gauge wires are embedded in a polyimide polymer flexible substrate. The whole gauge is fully encapsulated in the polyimide polymer. The external solder pads are copper coated. Its useful temperature range is $-75 \text{ }^\circ\text{C}$ to $+175 \text{ }^\circ\text{C}$. (Photo by SK)

Copyright © McGraw-Hill Education. All rights reserved. No reproduction or distribution without the prior written consent of McGraw-Hill Education.

Chapter 2

Answers to "Why?" in the text

Page 187, footnote 21

Figure below shows specular reflection, that is, a totally elastic collision of an electron with the surface of a film. If this were a rubber ball bouncing off a wall, then there would only be a change in the y -component v_y of the velocity, which would be reversed. The x -component is unchanged. The collision has no effect on the v_x component of the velocity. If there is an electric field in the $-x$ direction then the electron can continue to gain velocity from the field as if it never collided with the wall. Specular reflection does not increase the resistivity.

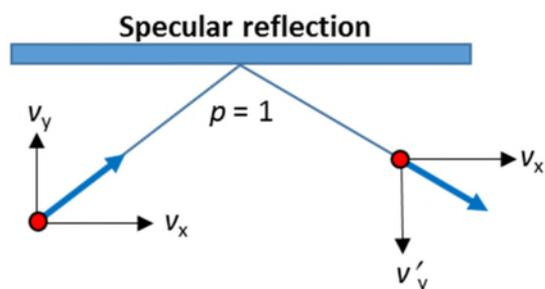

Page 196, footnote 21

"Pure Al suffers badly from electromigration problems and is usually alloyed with small amounts of Cu, called Al(Cu), to reduce electromigration to a tolerable level. But the resistivity increases. (Why?)" The increase is due to Matthiessen's rule. The added impurities (Cu) in Al provide an additional scattering mechanism.

2.1 Electrical conduction Na is a monovalent metal (BCC) with a density of 0.9712 g cm^{-3} . Its atomic mass is 22.99 g mol^{-1} . The drift mobility of electrons in Na is $53 \text{ cm}^2 \text{ V}^{-1} \text{ s}^{-1}$.

- Consider the collection of conduction electrons in the solid. If each Na atom donates one electron to the electron sea, *estimate* the mean separation between the electrons. (Note: if n is the concentration of particles, then the particles' mean separation $d = 1/n^{1/3}$.)
- Estimate the mean separation between an electron (e^-) and a metal ion (Na^+), assuming that most of the time the electron prefers to be between two neighboring Na^+ ions. What is the approximate Coulombic interaction energy (in eV) between an electron and an Na^+ ion?
- How does this electron/metal-ion interaction energy compare with the average thermal energy per particle, according to the kinetic molecular theory of matter? Do you expect the kinetic molecular theory to be applicable to the conduction electrons in Na? If the mean electron/metal-ion interaction energy is of the same order of magnitude as the mean KE of the electrons, what is the mean speed of electrons in Na? Why should the mean kinetic energy be comparable to the mean electron/metal-ion interaction energy?

- d. Calculate the electrical conductivity of Na and compare this with the experimental value of $2.1 \times 10^7 \Omega^{-1} \text{ m}^{-1}$ and comment on the difference.

Solution

a. If D is the density, M_{at} is the atomic mass and N_A is Avogadro's number, then the atomic concentration n_{at} is

$$n_{\text{at}} = \frac{DN_A}{M_{\text{at}}} = \frac{(971.2 \text{ kg m}^{-3})(6.022 \times 10^{23} \text{ mol}^{-1})}{(22.99 \times 10^{-3} \text{ kg mol}^{-1})} = 2.544 \times 10^{28} \text{ m}^{-3}$$

which is also the electron concentration, given that each Na atom contributes 1 conduction electron.

If d is the mean separation between the electrons then d and n_{at} are related by (see Chapter 1 Solutions, Q1.11; this is only an estimate)

$$d \approx \frac{1}{n_{\text{at}}^{1/3}} = \frac{1}{(2.544 \times 10^{28} \text{ m}^{-3})^{1/3}} = 3.40 \times 10^{-10} \text{ m or } 0.34 \text{ nm}$$

b. Na is BCC with 2 atoms in the unit cell. So if a is the lattice constant (side of the cubic unit cell), the density is given by

$$D = \frac{(\text{atoms in unit cell})(\text{mass of 1 atom})}{\text{volume of unit cell}} = \frac{2 \left(\frac{M_{\text{at}}}{N_A} \right)}{a^3}$$

$$\text{isolate for } a, \quad a = \left[\frac{2M_{\text{at}}}{DN_A} \right]^{1/3} = \left[\frac{2(22.99 \times 10^{-3} \text{ kg mol}^{-1})}{(0.9712 \times 10^3 \text{ kg m}^{-3})(6.022 \times 10^{23} \text{ mol}^{-1})} \right]^{1/3}$$

$$\text{so that} \quad a = 4.284 \times 10^{-10} \text{ m or } 0.4284 \text{ nm}$$

For the BCC structure, the radius of the metal ion R and the lattice parameter a are related by $(4R)^2 = 3a^2$, so that,

$$R = (1/4)\sqrt{(3a^2)} = 1.855 \times 10^{-10} \text{ m or } 0.1855 \text{ nm}$$

If the electron is somewhere roughly between two metal ions, then the mean electron to metal ion separation $d_{\text{electron-ion}}$ is roughly R . If $d_{\text{electron-ion}} \approx R$, the electrostatic potential energy PE between a conduction electron and one metal ion is then

$$PE = \frac{(-e)(+e)}{4\pi\epsilon_0 d_{\text{electron-ion}}} = \frac{(-1.602 \times 10^{-19} \text{ C})(+1.602 \times 10^{-19} \text{ C})}{4\pi(8.854 \times 10^{-12} \text{ F m}^{-1})(1.855 \times 10^{-10} \text{ m})} \quad (1)$$

$$\therefore \quad PE = -1.24 \times 10^{-18} \text{ J or } -7.76 \text{ eV}$$

c. This electron-ion PE is much larger than the average thermal energy expected from the kinetic theory for a collection of “free” particles, that is $E_{\text{average}} = KE_{\text{average}} = 3(kT/2) \approx 0.039 \text{ eV}$ at 300 K. In the case of Na, the electron-ion interaction is very strong so we cannot assume that the electrons are moving around freely as if in the case of free gas particles in a cylinder. If we assume that the mean KE is roughly the same order of magnitude as the mean PE ,

$$KE_{\text{average}} = \frac{1}{2} m_e u^2 \approx |PE|_{\text{average}} = -1.24 \times 10^{-18} \text{ J} \quad (2)$$

where u is the mean speed (strictly, u = root mean square velocity) and m_e is the electron mass.

$$\text{Thus, } u \approx \left[\frac{2PE_{\text{average}}}{m_e} \right]^{1/2} = \left[\frac{2(1.24 \times 10^{-18} \text{ J})}{(9.109 \times 10^{-31} \text{ kg})} \right]^{1/2} \quad (3)$$

so that $u = 1.65 \times 10^6 \text{ m/s}$

There is a theorem in classical physics called the *Virial theorem* which states that if the interactions between particles in a system obey the inverse square law (as in Coulombic interactions) then the magnitude of the mean KE is equal to the magnitude of the mean PE . The Virial Theorem states that:

$$KE_{\text{average}} = -\frac{1}{2} PE_{\text{average}}$$

Indeed, using this expression in Eqn. (2), we would find that $u = 1.05 \times 10^6 \text{ m/s}$. If the conduction electrons were moving around freely and obeying the kinetic theory, then we would expect $(1/2)m_e u^2 = (3/2)kT$ and $u = 1.1 \times 10^5 \text{ m/s}$, a much lower mean speed. Further, kinetic theory predicts that u increases as $T^{1/2}$ whereas according to Eqns. (1) and (2), u is insensitive to the temperature. The experimental linear dependence between the resistivity ρ and the absolute temperature T for most metals (non-magnetic) can only be explained by taking $u = \text{constant}$ as implied by Eqns. (1) and (2).

d. If μ is the drift mobility of the conduction electrons and n is their concentration, then the electrical conductivity of Na is $\sigma = en\mu$. Assuming that each Na atom donates one conduction electron ($n = n_{at}$), we have

$$\sigma = en\mu = (1.602 \times 10^{-19} \text{ C})(2.544 \times 10^{28} \text{ m}^{-3})(53 \times 10^{-4} \text{ m}^2 \text{ V}^{-1} \text{ s}^{-1})$$

$$\text{i.e. } \sigma = 2.16 \times 10^7 \Omega^{-1} \text{ m}^{-1}$$

which is quite close to the experimental value.

Nota Bene: If one takes the $\text{Na}^+ - \text{Na}^+$ separation $2R$ to be roughly the mean electron-electron separation then this is 0.37 nm and close to $d = 1/(n^{1/3}) = 0.34 \text{ nm}$. In any event, all calculations are only approximate to highlight the main point. The interaction PE is substantial compared with the mean thermal energy and we cannot use $(3/2)kT$ for the mean KE !

2.2 Electrical conduction The resistivity of aluminum at 25 °C has been measured to be $2.72 \times 10^{-8} \Omega \text{ m}$. The thermal coefficient of resistivity of aluminum at 0 °C is $4.29 \times 10^{-3} \text{ K}^{-1}$. Aluminum has a valency of 3, a density of 2.70 g cm^{-3} , and an atomic mass of 27.

- Calculate the resistivity of aluminum at -40°C .
- What is the thermal coefficient of resistivity at -40°C ?
- Estimate the mean free time between collisions for the conduction electrons in aluminum at 25 °C, and hence estimate their drift mobility.

- d. If the mean speed of the conduction electrons is about $2 \times 10^6 \text{ m s}^{-1}$, calculate the mean free path and compare this with the interatomic separation in Al (Al is FCC). What should be the thickness of an Al film that is deposited on an IC chip such that its resistivity is the same as that of bulk Al?
- e. What is the percentage change in the power loss due to Joule heating of the aluminum wire when the temperature drops from 25°C to -40°C ?

Solution

a. Apply the equation for temperature dependence of resistivity, $\rho(T) = \rho_o[1 + \alpha_o(T - T_o)]$. We have the temperature coefficient of resistivity, α_o , at T_o where T_o is the reference temperature. We can either work in K or $^\circ\text{C}$ inasmuch as only temperature changes are involved. The two given reference temperatures are 0°C or 25°C , depending on choice. Taking $T_o = 0^\circ\text{C}$,

$$\rho(-40^\circ\text{C}) = \rho_o[1 + \alpha_o(-40^\circ\text{C} - 0^\circ\text{C})]$$

$$\rho(25^\circ\text{C}) = \rho_o[1 + \alpha_o(25^\circ\text{C} - 0^\circ\text{C})]$$

Divide the above two equations to eliminate ρ_o ,

$$\rho(-40^\circ\text{C})/\rho(25^\circ\text{C}) = [1 + \alpha_o(-40^\circ\text{C})] / [1 + \alpha_o(25^\circ\text{C})]$$

Next, substitute the given values $\rho(25^\circ\text{C}) = 2.72 \times 10^{-8} \Omega \text{ m}$ and $\alpha_o = 4.29 \times 10^{-3} \text{ K}^{-1}$ to obtain

$$\rho(-40^\circ\text{C}) = (2.72 \times 10^{-8} \Omega \text{ m}) \frac{[1 + (4.29 \times 10^{-3})(-40)]}{[1 + (4.29 \times 10^{-3})(25)]} = \mathbf{2.035 \times 10^{-8} \Omega \text{ m}}$$

b. In $\rho(T) = \rho_o[1 + \alpha_o(T - T_o)]$ we have α_o at T_o where T_o is the reference temperature, for example, 0°C or 25°C depending on choice. We will choose T_o to be first at 0°C and then at -40°C ($= T_2$) so that the resistivity at T_2 and then at T_o are:

At T_2 , $\rho_2 = \rho_o[1 + \alpha_o(T_2 - T_o)]$; the reference being T_o and ρ_o which defines α_o

and at T_o $\rho_o = \rho_2[1 + \alpha_2(T_o - T_2)]$; the reference being T_2 and ρ_2 which defines α_2

Rearranging the above two equations we find

$$\alpha_2 = \alpha_o / [1 + (T_2 - T_o)\alpha_o]$$

i.e. $\alpha_{-40} = (4.29 \times 10^{-3}) / [1 + (-40 - 0)(4.29 \times 10^{-3})] = \mathbf{5.18 \times 10^{-3} \text{ }^\circ\text{C}^{-1}}$

Alternatively, consider the definition of α_2 that is α_{-40}

$$\text{From } \alpha_o = \frac{1}{\rho_o} \left[\frac{d\rho}{dT} \right]_{T_o}$$

we have $\alpha_{-40} = \{1/[\rho(-40^\circ\text{C})]\} \times \{[\rho(25^\circ\text{C}) - \rho(-40^\circ\text{C})] / [(25^\circ\text{C}) - (-40^\circ\text{C})]\}$

$\therefore \alpha_{-40} = 1 / [(2.035 \times 10^{-8})] \times \{(2.72 \times 10^{-8}) - (2.035 \times 10^{-8})\} / [(25) - (-40)]\}$

$\therefore \alpha_{-40} = \mathbf{5.18 \times 10^{-3} \text{ K}^{-1}}$

c. We know that $1/\rho = \sigma = en\mu$ where σ is the electrical conductivity, e is the electron charge, and μ is the electron drift mobility. We also know that $\mu = e\tau / m_e$, where τ is the mean free time between electron collisions and m_e is the electron mass. Therefore,

$$1/\rho = e^2 n \tau / m_e$$

$$\therefore \tau = m_e / \rho e^2 n \quad (1)$$

Here n is the number of conduction electrons per unit volume. But, from the density d and atomic mass M_{at} , atomic concentration of Al is

$$n_{\text{Al}} = \frac{N_A d}{M_{\text{at}}} = \frac{(6.022 \times 10^{23} \text{ mol}^{-1})(2700 \text{ kg/m}^3)}{(0.027 \text{ kg/mol})} = 6.022 \times 10^{28} \text{ m}^{-3}$$

so that $n = 3n_{\text{Al}} = 1.807 \times 10^{29} \text{ m}^{-3}$

assuming that each Al atom contributes 3 "free" conduction electrons to the metal and substituting into (1),

$$\tau = \frac{m_e}{\rho e^2 n} = \frac{(9.109 \times 10^{-31} \text{ kg})}{(2.72 \times 10^{-8} \text{ } \Omega \text{ m})(1.602 \times 10^{-19} \text{ C})^2 (1.807 \times 10^{29} \text{ m}^{-3})}$$

$$\therefore \tau = 7.22 \times 10^{-15} \text{ s}$$

(Note: If you do not convert to meters and instead use centimeters you will not get the correct answer because seconds is an SI unit.)

The relation between the drift mobility μ_d and the mean free time is given by Equation 2.5, so that

$$\mu_d = \frac{e\tau}{m_e} = \frac{(1.602 \times 10^{-19} \text{ C})(7.22 \times 10^{-15} \text{ s})}{(9.109 \times 10^{-31} \text{ kg})}$$

$$\therefore \mu_d = 1.27 \times 10^{-3} \text{ m}^2 \text{ V}^{-1} \text{ s}^{-1} = 12.7 \text{ cm}^2 \text{ V}^{-1} \text{ s}^{-1}$$

d. The mean free path is $l = u\tau$, where u is the mean speed. With $u \approx 2 \times 10^6 \text{ m s}^{-1}$ we find the mean free path:

$$l = u\tau = (2 \times 10^6 \text{ m s}^{-1})(7.22 \times 10^{-15} \text{ s}) \approx 1.44 \times 10^{-8} \text{ m} \approx 14.4 \text{ nm}$$

A thin film of Al must have a much greater thickness than l to show bulk behavior. Otherwise, scattering from the surfaces will increase the resistivity by virtue of Matthiessen's rule.

e. Power $P = I^2 R$ and is proportional to the resistivity ρ , assuming the rms current level stays relatively constant. Then we have

$$\begin{aligned} [P(-40^\circ \text{C}) - P(25^\circ \text{C})] / P(25^\circ \text{C}) &= P(-40^\circ \text{C}) / P(25^\circ \text{C}) - 1 = \rho(-40^\circ \text{C}) / \rho(25^\circ \text{C}) - 1 \\ &= (2.03 \times 10^{-8} \text{ } \Omega \text{ m} / 2.72 \times 10^{-8} \text{ } \Omega \text{ m}) - 1 = -0.254, \text{ or } -25.4\% \end{aligned}$$

(Negative sign means a reduction in the power loss).

2.3 Conduction in gold Gold is in the same group as Cu and Ag. Assuming that each Au atom donates one conduction electron, calculate the drift mobility of the electrons in gold at 22° C. What is the mean free path of the conduction electrons if their mean speed is $1.4 \times 10^6 \text{ m s}^{-1}$? (Use ρ_o and α_o in Table 2.1.)

Solution

The drift mobility of electrons can be obtained by using the conductivity relation $\sigma = en\mu_d$.

Resistivity of pure gold from Table 2.1 at 0°C (273 K) is $\rho_0 = 20.50 \text{ n}\Omega \text{ m}$. Resistivity at 20 °C can be calculated by.

$$\rho = \rho_0[1 + \alpha_0(T - T_0)]$$

The TCR α_0 for Au from Table 2.1 is $1/242 \text{ K}^{-1}$. Therefore the resistivity for Au at 22°C is

$$\rho(22^\circ\text{C}) = 20.50 \text{ n}\Omega \text{ m} [1 + (1/242) \text{ K}^{-1}(293 \text{ K} - 273 \text{ K})] = 22.36 \text{ n}\Omega \text{ m}$$

Since one Au atom donates one conduction electron, the electron concentration is

$$n = \frac{dN_A}{M_{at}}$$

where for gold $d = \text{density} = 19300 \text{ kg m}^{-3}$, atomic mass $M_{at} = 196.67 \text{ g mol}^{-1}$. Substituting for d , N_A , and M_{at} , we have $n = 5.91 \times 10^{28} \text{ m}^{-3}$, or $5.91 \times 10^{22} \text{ cm}^{-3}$.

$$\begin{aligned} \mu_d &= \frac{\sigma}{en} = \frac{(22.36 \times 10^{-9} \Omega \text{ m})^{-1}}{(1.6022 \times 10^{-19} \text{ C})(5.91 \times 10^{28} \text{ m}^{-3})} \\ &= 4.72 \times 10^{-3} \text{ m}^2 \text{ V}^{-1} \text{ s}^{-1} = 47.2 \text{ cm}^2 \text{ V}^{-1} \text{ s}^{-1}. \end{aligned}$$

Given the mean speed of electron is $u = 1.4 \times 10^6 \text{ m s}^{-1}$, mean free path is

$$\begin{aligned} l &= \frac{\mu_d m_e u}{e} = \frac{(4.72 \times 10^{-3} \text{ m}^2 \text{ V}^{-1} \text{ s}^{-1})(9.109 \times 10^{-31} \text{ kg})(1.4 \times 10^6 \text{ m s}^{-1})}{1.6022 \times 10^{-19} \text{ C}} \\ &= 3.76 \times 10^{-8} \text{ m} = 37.6 \text{ nm} \end{aligned}$$

Note: The lattice parameter for Au (which is FCC), $a = 408 \text{ pm}$ or 0.408 nm . Thus $l/a = 92$. The electron traveling along the cube edge travels for 92 unit cells before it is scattered.

2.4 Mean free time between collisions Let $1/\tau$ be the mean probability per unit time that a conduction electron in a metal collides with (or is scattered by) lattice vibrations, impurities or defects etc. Then the probability that an electron makes a collision in a small time interval δt is $\delta t/\tau$. Suppose that $n(t)$ is the concentration of electrons that have not yet collided. The change δn in the uncollided electron concentration is then $-n\delta t/\tau$. Thus, $\delta n = -n\delta t/\tau$, or $\delta n/n = -\delta t/\tau$. We can integrate this from $n = n_0$ at $x = 0$ to $n = n(t)$ at time t to find the concentration of uncollided electrons $n(t)$ at t

$$n(t) = n_0 \exp(-t/\tau) \quad \text{Concentration of uncollided electrons} \quad [2.85]$$

Show that the mean free time and mean square free time are given by

$$\bar{t} = \frac{\int_0^\infty t n(t) dt}{\int_0^\infty n(t) dt} = \tau \quad \text{and} \quad \overline{t^2} = \frac{\int_0^\infty t^2 n(t) dt}{\int_0^\infty n(t) dt} = 2\tau^2 \quad \text{Electron scattering statistics} \quad [2.86]$$

What is your conclusion?

Solution

Consider

$$\bar{t} = \frac{\int_0^{\infty} tn(t)dt}{\int_0^{\infty} n(t)dt} = \frac{n_o \int_0^{\infty} t \exp(-t/\tau)dt}{n_o \int_0^{\infty} \exp(-t/\tau)dt} = \frac{\int_0^{\infty} t \exp(-t/\tau)dt}{-\tau [\exp(-t/\tau)]_{t=0}^{\infty}} = (1/\tau) \int_0^{\infty} t \exp(-t/\tau)dt \quad (1)$$

The last term can be integrated by parts (for example, online at <http://www.wolframalpha.com>) to find,

$$\int x \exp(-ax) dx = -\frac{e^{-ax}(ax+1)}{a^2}$$

or in terms of the integration limits, that is, as a definite integral,

$$\int_0^{\infty} x \exp(-ax) dx = \frac{1}{a^2}$$

Thus, Equation (1) becomes

$$\bar{t} = (1/\tau) \int_0^{\infty} t \exp(-t/\tau)dt = (1/\tau)(\tau^2) = \tau$$

Now consider

$$\bar{t}^2 = \frac{\int_0^{\infty} t^2 n(t)dt}{\int_0^{\infty} n(t)dt} = \frac{n_o \int_0^{\infty} t^2 \exp(-t/\tau)dt}{n_o \int_0^{\infty} \exp(-t/\tau)dt} = (1/\tau) \int_0^{\infty} t^2 \exp(-t/\tau)dt \quad (2)$$

The definite integral can be evaluated or looked up (for example online at <http://www.wolframalpha.com>)

$$\int_0^{\infty} x^2 \exp(-ax) dx = \frac{2}{a^3}$$

Thus Equation (2) becomes,

$$\bar{t}^2 = (1/\tau) \int_0^{\infty} t^2 \exp(-t/\tau)dt = (1/\tau)[2\tau^3] = 2\tau^2$$

2.5 Effective number of conduction electrons per atom

- Electron drift mobility in tin (Sn) is $3.9 \text{ cm}^2 \text{ V}^{-1} \text{ s}^{-1}$. The room temperature ($20 \text{ }^\circ\text{C}$) resistivity of Sn is about $110 \text{ n}\Omega \text{ m}$. Atomic mass M_{at} and density of Sn are $118.69 \text{ g mol}^{-1}$ and 7.30 g cm^{-3} , respectively. How many “free” electrons are donated by each Sn atom in the crystal? How does this compare with the position of Sn in Group IVB of the Periodic Table?
- Consider the resistivity of few selected metals from Groups I to IV in the Periodic Table in Table 2.8. Calculate the number of conduction electrons contributed per atom and compare this with the location of the element in the Periodic Table. What is your conclusion?

Table 2.8 Selection of metals from Groups I to IV in the Periodic Table

Metal	Periodic Group	Valency	Density (g cm ⁻³)	Resistivity (nΩ m)	Mobility (cm ² V ⁻¹ s ⁻¹)
Na	IA	1	0.97	42.0	53
Mg	IIA	2	1.74	44.5	17
Ag	IB	1	10.5	15.9	56
Zn	IIB	2	7.14	59.2	8
Al	IIIB	3	2.7	26.5	12
Sn	IVB	4	7.30	110	3.9
Pb	IVB	4	11.4	206	2.3

NOTE: Mobility from Hall-effect measurements.

Solution

a. Electron concentration can be calculated from the conductivity of Sn, $\sigma = en\mu_d$.

$$n_e = \frac{\sigma}{e\mu_d} = \frac{(110 \times 10^{-9} \Omega \text{ m})^{-1}}{(1.602 \times 10^{-19} \text{ C})(3.9 \times 10^{-4} \text{ m}^2 \text{ V}^{-1} \text{ s}^{-1})}$$

$$= 1.46 \times 10^{29} \text{ electrons m}^{-3}.$$

The atomic concentration, *i.e.* number of Sn atoms per unit volume is

$$n_{\text{at}} = \frac{dN_A}{M_{\text{at}}} = \frac{(7.3 \times 10^3 \text{ kg})(6.022 \times 10^{23} \text{ mol}^{-1})}{(118.69 \times 10^{-3} \text{ kg mol}^{-1})}$$

$$= 3.70 \times 10^{28} \text{ Sn atoms m}^{-3}.$$

Hence the number of electrons donated by each atom is $(n_e/n_{\text{at}}) = 3.94$ or **4** electrons per Sn atom. This is in good agreement with the position of the Sn in the Periodic Table (IVB) and its valency of 4.

b. Using the same method used above, the number of electrons donated by each atom of the element are calculated and tabulated as follows in Table 2Q05.

Table 2Q05 Number of electrons donated by various elements

Metal	Periodic Group	Valency	Atomic Concentration n_{at} (m ⁻³)	Electron Concentration n_e (m ⁻³)	Number of electrons n_e/n_{at}	Integer (n_e/n_{at})
Na	IA	1	2.541×10^{28}	2.808×10^{28}	1.11	1
Mg	IIA	2	4.311×10^{28}	8.262×10^{28}	1.91	2
Ag	IB	1	5.862×10^{28}	7.019×10^{28}	1.20	1
Zn	IIB	2	6.575×10^{28}	1.320×10^{29}	2.00	2
Al	IIIB	3	6.026×10^{28}	1.965×10^{29}	3.26	3
Sn	IVB	4	3.703×10^{28}	1.457×10^{29}	3.93	4
Pb	IVB	4	3.313×10^{28}	1.319×10^{29}	3.98	4

As evident from the above table, the calculated number of electrons donated by one atom of the element is the same as the valency of that element and the position in the periodic table.

Table 2Q05 Number of electrons donated by various elements in Excel

N_A	q									
6.02E+23	1.60E-19	Unit =>	g / cm ³	nΩ m	cm ² / (Vs)	g /mol	1/m ³	1/m ³		
Element	Group	Valency	Density	Resistivity	Mobility	Atomic Mass	n(atomic)	n(electron)	ne/na	Integer
Na	IA	1	0.97	42	53	22.99	2.5408E+28	2.804E+28	1.10	1
Mg	IIA	2	1.74	44.5	17	24.31	4.3103E+28	8.251E+28	1.91	2
Ag	IB	1	10.5	15.9	56	107.87	5.8618E+28	7.011E+28	1.20	1
Zn	IIB	2	7.14	59.2	8	65.39	6.5755E+28	1.318E+29	2.00	2
Al	IIIB	3	2.7	26.5	12	26.98	6.0265E+28	1.963E+29	3.26	3
Sn	IVB	4	7.3	110	3.9	118.71	3.7032E+28	1.455E+29	3.93	4
Pb	IVB	4	11.4	206	2.3	207.2	3.3133E+28	1.317E+29	3.98	4

2.6 Resistivity of Ta Consider the resistivity of tantalum, which is summarized in Table 2.9. Plot ρ against T on a log-log plot and find n for the behavior $\rho \propto T^n$. Find the TCR at 0 and 25 °C. What is your conclusion? (Data from the *CRC Handbook of Chemistry and Physics*, 96th Edition, 2015-2016)

Table 2.9 Resistivity of Ta

T (K)	200	273	293	298	300	400	500	600	700	800	900
ρ (nΩ m)	86.6	122	131	134	135	182	229	274	318	359	401

Solution

Enter the data into Excel

T (K)	Rho (nOhm m)
150	61.9
200	86.6
273	122
293	131
298	134
300	135
400	182
500	229
600	274
700	318
800	359
900	401

Figure 2Q06-1 shows a plot of resistivity vs. temperature on a log-log plot, from Excel. On a log-log plot, the "best line" is a power law fit on a log-log plot. The best power law fit generates

$$\rho(\text{n}\Omega\text{ m}) = (0.3642)T^{1.034}$$

so that $n = 1.034$

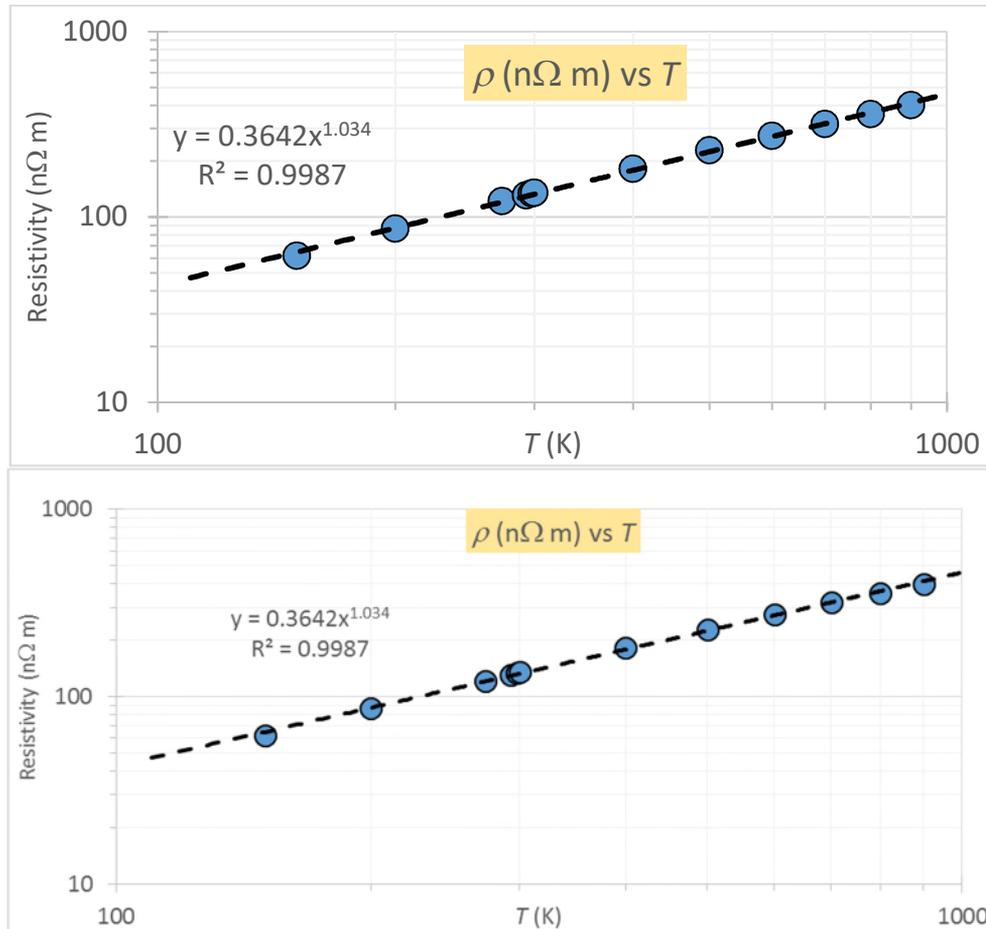

Figure 2Q06-1 Plot of resistivity vs. temperature on a log-log plot. The best line is a power law fit on a log-log plot. (Top, pasted as an editable Excel object, bottom, pasted as bitmap art)

***2.7 TCR of isomorphous alloys** Determine the composition of the Cu-Ni alloy that will have a TCR of $4 \times 10^{-4} \text{ K}^{-1}$, that is, a TCR that is an order of magnitude less than that of Cu. Over the composition range of interest, the resistivity of the Cu-Ni alloy can be calculated from $\rho_{\text{CuNi}} \approx \rho_{\text{Cu}} + C_{\text{eff}} X (1-X)$, where C_{eff} , the effective Nordheim coefficient, is about 1310 nΩ m.

Solution

Assume room temperature $T = 293 \text{ K}$. Using values for copper from Table 2.1 in Equation 2.19, $\rho_{\text{Cu}} = 17.1 \text{ n}\Omega\text{ m}$ and $\alpha_{\text{Cu}} = 4.0 \times 10^{-3} \text{ K}^{-1}$, and from Table 2.3 the effective Nordheim coefficient of Ni dissolved in Cu is $C = 1310 \text{ n}\Omega\text{ m}$. We want to find the composition of the alloy such that $\alpha_{\text{CuNi}} = 4 \times 10^{-4} \text{ K}^{-1}$. Then,

$$\rho_{\text{alloy}} = \frac{\alpha_{\text{Cu}} \rho_{\text{Cu}}}{\alpha_{\text{alloy}}} = \frac{(0.0040 \text{ K}^{-1})(17.1 \text{ n}\Omega\text{ m})}{0.0004 \text{ K}^{-1}} = 171.0 \text{ n}\Omega\text{ m}$$

Using Nordheim's rule:

$$\rho_{\text{alloy}} = \rho_{\text{Cu}} + CX(1 - X)$$

$$\text{i.e.} \quad 171.0 \text{ n}\Omega \text{ m} = 17.1 \text{ n}\Omega \text{ m} + (1310 \text{ n}\Omega \text{ m})X(1 - X)$$

$$\therefore \quad X^2 - X + 0.1175 = 0$$

solving the quadratic, we find $X = \mathbf{0.136}$

Thus the composition is **86.4% Cu-13.6% Ni**. However, this value is in *atomic percent* as the Nordheim coefficient is in atomic percent. Note that as Cu and Ni are very close in the Periodic Table this would also be the weight percentage. Note: the quadratic will produce another value, namely $X = 0.866$. However, using this number to obtain a composition of 13.6% Cu-86.4% Ni is incorrect because the values we used in calculations corresponded to a solution of Ni dissolved in Cu, not vice-versa (*i.e.* Ni was taken to be the impurity).

Note: From the Nordheim rule, the resistivity of the alloy is $\rho_{\text{alloy}} = \rho_o + CX(1 - X)$. We can find the TCR of the alloy from its definition

$$\alpha_{\text{alloy}} = \frac{1}{\rho_{\text{alloy}}} \frac{d\rho_{\text{alloy}}}{dT} = \frac{1}{\rho_{\text{alloy}}} \frac{d}{dT} [\rho_o + CX(1 - X)]$$

To obtain the desired equation, **we must assume that C is temperature independent** (*i.e.* the increase in the resistivity depends on the lattice distortion induced by the impurity) so that $d[CX(1 - X)]/dT = 0$, enabling us to substitute for $d\rho_o/dT$ using the definition of the TCR: $\alpha_o = (d\rho_o/dT)/\rho_o$. Substituting into the above equation:

$$\alpha_{\text{alloy}} = \frac{1}{\rho_{\text{alloy}}} \frac{d\rho_o}{dT} = \frac{1}{\rho_{\text{alloy}}} \alpha_o \rho_o$$

$$\text{i.e.} \quad \alpha_{\text{alloy}} \rho_{\text{alloy}} = \alpha_o \rho_o \quad \text{or} \quad \alpha_{AB} \rho_{AB} = \alpha_A \rho_A$$

Remember that all values for the alloy and pure substance must all be taken at the same temperature, or the equation is invalid.

Comment: Nordheim's rule does not work particularly well for alloys in which one or both elements are transition metals. Its applicability in alloys that involve a transition metal is only approximate as mentioned in the text. The alloy resistivity in these cases is given by

$$\rho_{\text{alloy}} = \rho_{\text{Cu}} + CX(1 - X) + \rho_{s-d}$$

where ρ_{s-d} is an additional resistivity term arising from additional scattering mechanism due to the addition of transition metals. This term depends on $X^2(1-X)$, which has been neglected. Its inclusion does not dramatically change the results.

2.8 Resistivity of isomorphous alloys and Nordheim's rule What are the maximum atomic and weight percentages of Cu that can be added to Au without exceeding a resistivity that is twice that of pure gold? What are the maximum atomic and weight percentages of Au that can be added to pure Cu without exceeding twice the resistivity of pure copper? (Alloys are normally prepared by mixing the elements in weight.)

Solution

Cu added Au

From combined Matthiessen and Nordheim rule,

$$\rho_{\text{Alloy}} = \rho_{\text{Au}} + \rho_I,$$

with $\rho_I = CX(1-X)$ is the increase in resistivity due to Cu addition (impurities). In order to keep the resistivity of the alloy less than twice of pure gold, the resistivity of solute (Cu), should be less than resistivity of pure gold, i.e. $\rho_I = CX(1-X) < \rho_{\text{Au}}$. From Table 2.3, Nordheim coefficient for Cu in Au at 20°C is $C = 450 \text{ n}\Omega \text{ m}$. Resistivity of Au at 20°C, using $\alpha_0 = 1/242 \text{ K}^{-1}$ in Table 2.1 is

$$\rho = \rho_0[1 + \alpha_0(T - T_0)] = (20.5 \text{ n}\Omega \text{ m})[1 + \frac{1}{242} \text{ K}^{-1}(293\text{K} - 273\text{K})] = 22.2 \text{ n}\Omega \text{ m}$$

Therefore the condition for solute (Cu) atomic fraction is

$$\rho_{\text{Alloy}} = \rho_{\text{Au}} + \rho_I < 2\rho_{\text{Au}}$$

$$\therefore \rho_I < \rho_{\text{Au}}$$

$$\text{or } CX(1-X) < 22.2 \text{ n}\Omega \text{ m}.$$

$$\therefore X(1-X) < (22.2 \text{ n}\Omega \text{ m}) / (450 \text{ n}\Omega \text{ m}) = 0.0493$$

Consider the equality case, the maximum Cu addition,

$$X^2 - X + 0.0493 = 0$$

Solving the above equation, we have $X = \mathbf{0.052}$ or $\mathbf{5.2\%}$ (atomic). Therefore the atomic fraction of Cu should be less than 0.052 or 5.2% in order to keep the overall resistivity of the alloy less than twice the resistivity of pure Au. The weight fraction for Cu for this atomic fraction can be calculated from

$$w_{\text{Cu}} = \frac{XM_{\text{Cu}}}{XM_{\text{Cu}} + (1-X)M_{\text{Au}}} = \frac{(0.052)(63.54 \text{ g mol}^{-1})}{(0.052)(63.54 \text{ g mol}^{-1}) + (1-0.052)(196.67 \text{ g mol}^{-1})}$$

$$= \mathbf{0.0174}$$
 or $\mathbf{1.74\%}$ (weight).

Au added to Cu

Now, we discuss the case of Au in Cu, i.e. Au as solute in Cu alloy. Resistivity of Cu at 0°C is 15.4 nΩ m (Table 2.1) and $\alpha_0 = 1/(235 \text{ K})$. Therefore the resistivity of Cu at 20°C is

$$\rho = \rho_0[1 + \alpha_0(T - T_0)] = 15.4 \text{ n}\Omega \text{ m}[1 + \frac{1}{235} \text{ K}^{-1}(293\text{K} - 273\text{K})] = 16.71 \text{ n}\Omega \text{ m}$$

Therefore the condition for solute (Au) atomic fraction is $\rho_I = CX(1-X) < \rho_{\text{Cu}} = 17.03 \text{ n}\Omega \text{ m}$. The Nordheim coefficient for Au in Cu at 20°C is, $C = 5500 \text{ n}\Omega \text{ m}$. Consider the equality case, the maximum Au addition case,

$$X(1-X) = (16.71 \text{ n}\Omega \text{ m}) / (5500 \text{ n}\Omega \text{ m}) = 3.04 \times 10^{-3}.$$

$$X^2 - X - 3.04 \times 10^{-3} = 0$$

Solving the above equation, we get $X = \mathbf{3.05 \times 10^{-3}}$ or $\mathbf{0.30\%}$ (atomic) for the maximum Au content we can add. Thus, the Au content has to be less than 0.30% (atomic percent) to keep the resistivity of alloy less than twice of pure Cu. The weight fraction for Cu for this atomic fraction can be calculated from

$$w_{Au} = \frac{XM_{Au}}{XM_{Au} + (1-X)M_{Cu}} = \frac{(3.04 \times 10^{-3})(196.67 \text{ g mol}^{-1})}{(3.04 \times 10^{-3})(196.67 \text{ g mol}^{-1}) + (1 - 3.04 \times 10^{-3})(63.54 \text{ g mol}^{-1})}$$

$$= 9.35 \times 10^{-3} \text{ or } 0.935\% \text{ (weight).}$$

2.9 Physical properties of alloys Consider Cu-Sn alloys, called phosphor bronze. Their properties are listed in Table 2.10 from the ASM Handbook. Plot these properties all in graph (using a log-scale for the properties axis) as a function of composition and deduce conclusions. How does κ/σ change? Compositions are wt. %. Assume the Cu-Sn is a solid solution over this composition range.

Table 2.10 Selected properties of Cu with Sn at 20 °C.

	ρ	κ	c_s	λ	E	d
	nΩ m	W m ⁻¹ K ⁻¹	J kg ⁻¹ K ⁻¹	×10 ⁻⁶	GPa	g cm ⁻³
Cu	17.1	391	385	17.0	115	8.94
98.7Cu-1.35Sn	36	208	380	17.8	117	8.89
92Cu-8Sn	133	62	380	18.2	110	8.80
90Cu-10Sn	157	50	380	18.4	110	8.78

Note: ρ is resistivity, κ is thermal conductivity, c_s is specific heat capacity, λ is linear expansion coefficient, E is Young's modulus and d is density.

Solution

We can convert wt% to at.% using

The atomic fractions of the constituents can be calculated using the relations proved above. The atomic masses of the components are $M_{Sn} = 118.71 \text{ g mol}^{-1}$ and $M_{Cu} = 63.54 \text{ g mol}^{-1}$. Applying the weight to atomic fraction conversion equation derived in Ch. 1 for $w_{Sn} = 0.01$ (10%) case

$$n_{Sn} = \frac{w_{Sn} / M_{Sn}}{\frac{w_{Sn}}{M_{Sn}} + \frac{w_{Cu}}{M_{Cu}}} = \frac{\frac{0.01}{118.71 \text{ g mol}^{-1}}}{\frac{0.01}{118.71 \text{ g mol}^{-1}} + \frac{(1-0.01)}{63.54 \text{ g mol}^{-1}}} = 0.0561$$

Other values are listed in table 2Q09-1

Table 2Q09-1 Conversion of wt.% to at.%

Mat (Cu)	63.55		Mat (Sn) =	118.71	
	X (wt)	X (at)	X(1-X)	$\Delta\rho$	ρ
				nΩ m	nΩ m
Cu	0	0	0	0	17.1
98.7Cu-1.35Sn	0.0135	0.00727	0.00722	18.9	36

92Cu-8Sn	0.08	0.04448	0.0425	115.9	133
90Cu-10Sn	0.1	0.05614	0.05299	139.9	157

Table 2Q09-2 Excel table for the plots

	A	B	C	D	E	F	G	H	I	J	K	L	M
1	Mat (Cu)	63.55		Mat (Sn) =	118.71								
2		X (at)	X (at)	X(1-X)	$\Delta\rho$	ρ	σ	κ	κ/σ	c_s	λ	E	d
3					n Ω m	n Ω m	1/($\mu\Omega$ m)	W m ⁻¹ K ⁻¹		J kg ⁻¹ K ⁻¹	$\times 10^{-6}$	GPa	g cm ⁻³
4	Cu	0	0	0	0	17.1	58.479532	391	6.6861	385	17	115	8.94
5	98.7Cu-1.35Sn	0.00727	0.00727	0.00722	18.9	36	27.777778	208	7.488	380	17.8	117	8.89
6	92Cu-8Sn	0.04448	0.04448	0.042502	115.9	133	7.518797	62	8.246	380	18.2	110	8.8
7	90Cu-10Sn	0.05614	0.05614	0.052991	139.9	157	6.3694268	50	7.85	380	18.4	110	8.78

Figure 2Q09-1 shows various properties of Cu-Sn alloys as a function of Sn content in atomic percent. Clearly there are strong changes in the electrical resistivity and thermal conductivity whereas c_s , λ , E and d are hardly affected at all. The alloy retains metallic bonding, the Cu crystal structure and is a solid solution so there are no major changes in bonding or the crystal structure with up to ~ 5.6 at.% Sn added. The reason both electrical and thermal conductivity are affected strongly is that both depend on the motion of conduction electrons and how these are scattered. The introduction of foreign impurities that provide an additional scattering mechanism increases the resistivity per Matthiessen's rule.

Figure 2Q09-2 shows a plot of the resistivity vs. $X(1 - X)$, and it is clearly a straight line with a slope

$$\text{Slope} = C = 1571 \text{ n}\Omega \text{ m}$$

This is smaller than the value of C quoted in Table 2.1, which is taken from a handbook (1982).

We can also plot κ vs. σ as in Figure 2Q09-3. Clearly κ is proportional to σ as we expect from the Wiedemann-Franz-Lorenz law. The best fit line passing through the origin and gives a slope of

$$\text{Slope} = C_{\text{WFL}}T = 6.862 \times 10^{-6}$$

so that

$$C_{\text{WFL}} = (6.862 \times 10^{-6}) / (300) = 2.30 \times 10^{-8} \text{ W } \Omega \text{ K}^{-2}.$$

This value is about 5.7% different than the expected value in Equation 2.42.

NOTE: "Tin bronzes, with up 15.8% tin, retain the structure of alpha copper. The tin is a solid solution strengthener in copper, even though tin has a low solubility in copper at room temperature. The room temperature phase transformations are slow and usually do not occur, therefore these alloys are single phase alloys." From: The Website of the Copper Development Associate (https://www.copper.org/resources/properties/microstructure/cu_tin.html) accessed October 4, 2016

Note: The problem emphasizes the importance of electron scattering in controlling ρ and κ . Normally Cu-Sn phase diagram shows a very small solubility limit for Sn but, as explained above, these compositions are single phase solid solutions.

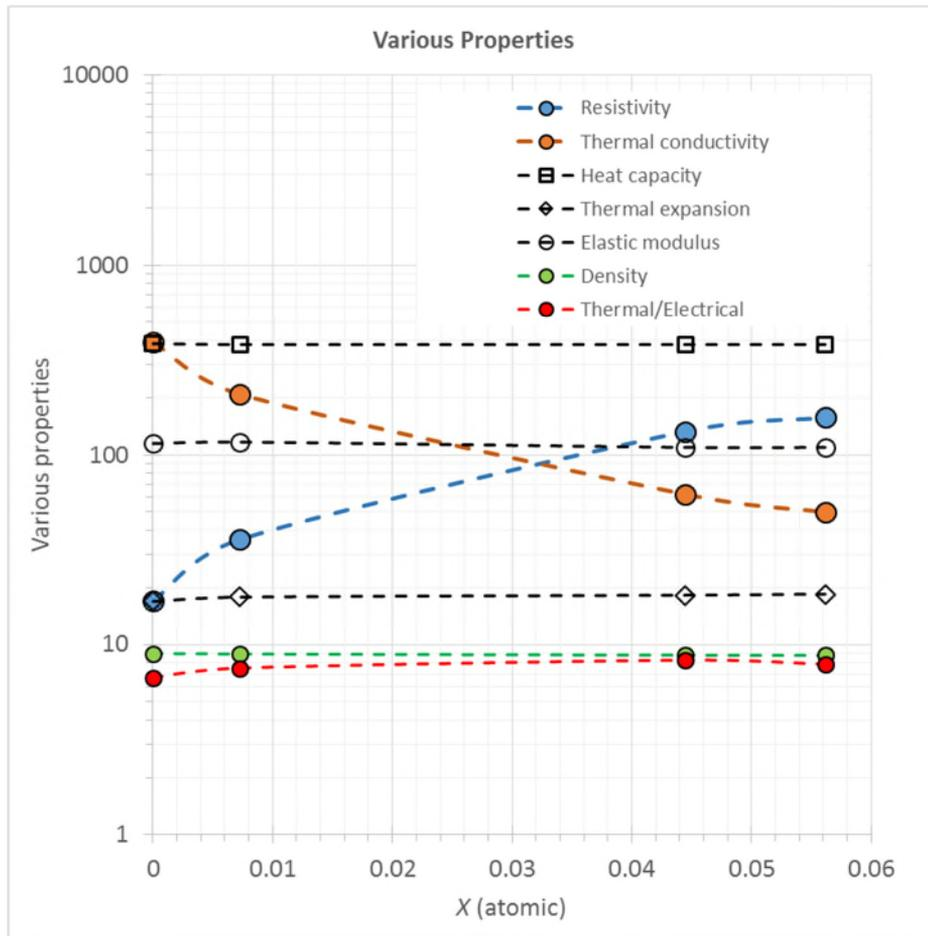

Figure 2Q09-1 Various properties of Cu-Sn alloys as a function of Sn content.

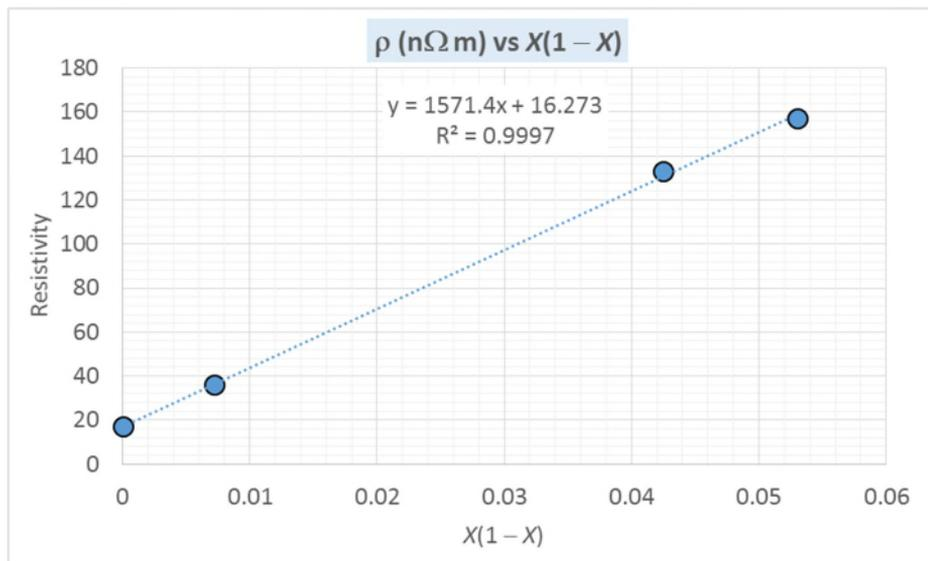

Figure 2Q09-2 Resistivity vs. $X(1 - X)$ for Cu-Sn alloys

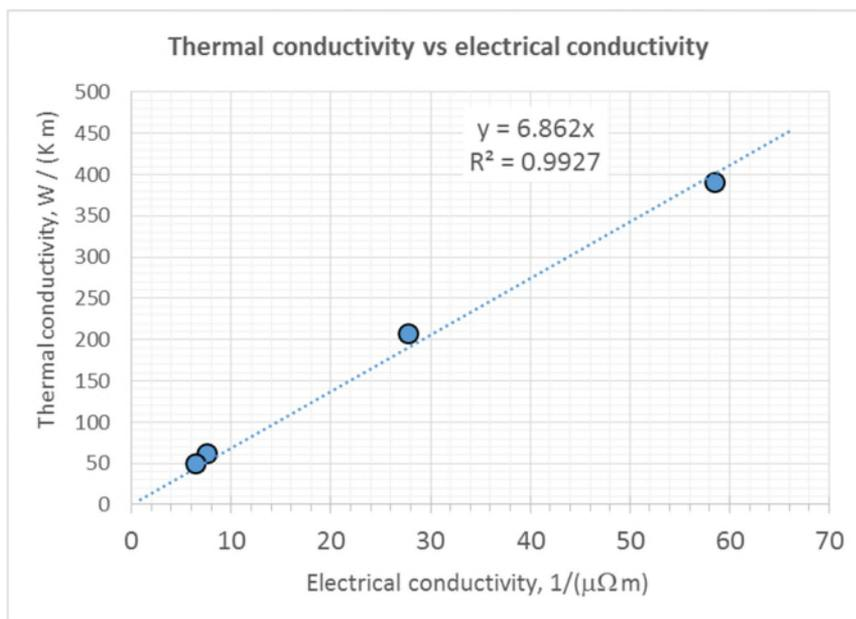

Figure 2Q09-3 κ vs. σ for Cu-Sn alloys

2.10 Nordheim’s rule and brass Brass is a Cu–Zn alloy. Table 2.11 shows some typical resistivity values for various Cu–Zn compositions in which the alloy is a solid solution (up to 30% Zn).

- Plot ρ versus $X(1 - X)$. From the slope of the best-fit line find the mean (effective) Nordheim coefficient C for Zn dissolved in Cu over this compositional range.
- Since X is the atomic fraction of Zn in brass, for each atom in the alloy, there are X Zn atoms and $(1 - X)$ Cu atoms. The conduction electrons consist of each Zn donating two electrons and each copper donating one electron. Thus, there are $2(X) + 1(1 - X) = 1 + X$ conduction electrons per atom. Since the conductivity is proportional to the electron concentration, the combined Nordheim-Matthiessens rule must be scaled up by $(1 + X)$.

$$\rho_{\text{brass}} = \frac{\rho_0 + CX(1 - X)}{(1 + X)}$$

Plot the data in Table 2.11 as $\rho(1 + X)$ versus $X(1 - X)$. From the best-fit line find C and ρ_0 . What is your conclusion? (Compare the correlation coefficients of the best-fit lines in your two plots).

NOTE: The approach in Question 2.10 is an empirical and a classical way to try and account for the fact that as the Zn concentration increases, the resistivity does not increase at a rate demanded by the Nordheim equation. An intuitive correction is then done by increasing the conduction electron concentration with Zn, based on valency. There is, however, a modern physics explanation that involves not only scattering from the introduction of impurities (Zn), but also changes in something called the "Fermi surface and density of states at the Fermi energy", which can be found in solid state physics textbooks.

Table 2.11 Cu-Zn brass alloys

Zn at.% in Cu–Zn	0	0.34	0.5	0.93	3.06	4.65	9.66	15.6	19.59	29.39
Resistivity $n\Omega m$	17	18.1	18.84	20.7	26.8	29.9	39.1	49.0	54.8	63.5

Data extracted from H. A. Fairbank, *Phys. Rev.*, **66**, 274, 1944.

Solution

a. We know the resistivity to be $\rho_{\text{alloy}} = \rho_o + CX(1-X)$ and we can construct the table in Table 2Q10-1.

Table 2Q10-1

Zn at.% X	$X(1-X)$	Resistivity of alloy	
		ρ_{alloy}	$\rho(1+X)$
0	0.0000	17.00	17.000
0.34	0.0034	18.10	18.162
0.5	0.0050	18.84	18.934
0.93	0.0092	20.70	20.893
3.06	0.0297	26.80	27.620
4.65	0.0443	29.90	31.290
9.66	0.0873	39.10	42.877
15.6	0.1317	49.00	56.644
19.59	0.1575	54.80	65.535
29.39	0.2075	63.50	82.163

We can now plot ρ_{alloy} versus $X(1-X)$. We have a best-fit straight line of the form $y = mx + b$, where m is the slope of the line. The slope is C_{eff} , the Nordheim coefficient.

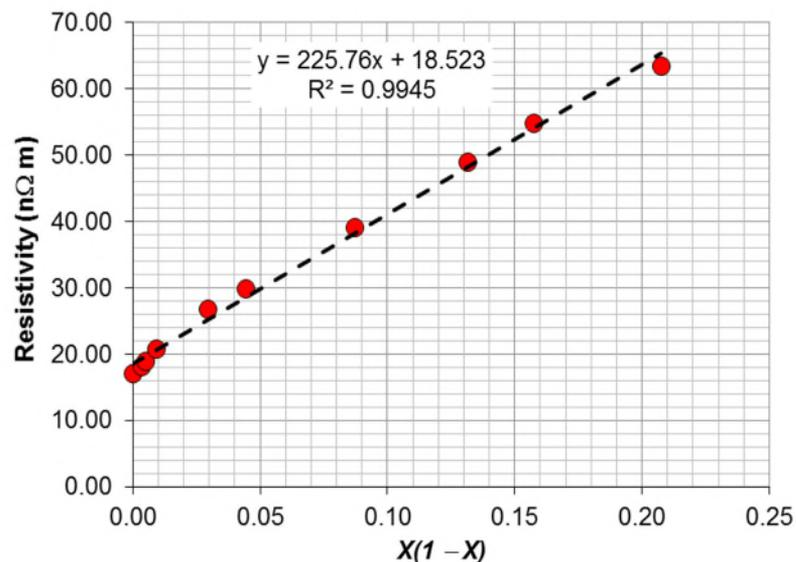

Figure 2Q10-1: Plot of alloy resistivity against $X(1-X)$

The equation of the line is $y = 225.76x + 18.523$. The slope m of the best-fit line is 225.76 nΩ m, which is the effective Nordheim coefficient C_{eff} for the compositional range of Zn provided.

b.

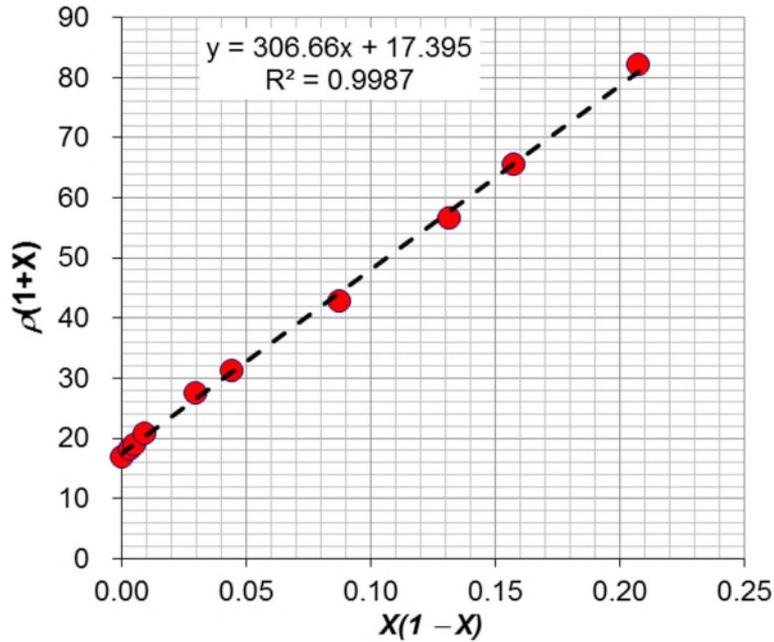

Figure 2Q10-2: Plot of $\rho(1+X)$ against $X(1-X)$

The slope of the best-fit line is 306.67. As given in the question, the modified combined Nordheim–Matthiessens rule must be scaled up by $(1 + X)$,

$$\rho_{\text{brass}} = \frac{\rho_0 + CX(1-X)}{(1+X)}$$

or
$$\rho_{\text{brass}}(1+X) = \rho_0 + CX(1-X)$$

The above equation is of the straight line form $y = mx + b$, where m is the slope of the line. Therefore from the equation of the line $y = 306.67x + 17.4$, we have the effective Nordheim coefficient is $C_{\text{eff}} = 306.67 \text{ n}\Omega \text{ m}$ and ρ_0 is $17.40 \text{ n}\Omega \text{ m}$.

If we calculate the resistivity using the values obtained above in the combined Nordheim-Mattheisen rule we obtain the following values in Table 2Q10-2

Table 2Q10-2: C_{eff} values calculated by fitting line to experimental data and by taking into account the effect of extra valence electron

Zn at.% X	Experimental Resistivity ($\text{n}\Omega \text{ m}$)	Case I	Case II
		Resistivity ($\text{n}\Omega \text{ m}$) $C_{\text{eff}} = 225.76 \text{ n}\Omega \text{ m}$	Resistivity ($\text{n}\Omega \text{ m}$) $C_{\text{eff}} = 306.67 \text{ n}\Omega \text{ m}$ Scaled by $(1 + X)$
0	17	17.00	17.00
0.34	18.1	17.76	17.98

0.5	18.84	18.12	18.43
0.93	20.7	19.08	19.64
3.06	26.8	23.70	25.32
4.65	29.9	27.01	29.24
9.66	39.1	36.70	39.91
15.6	49	46.72	49.63
19.59	54.8	52.56	54.61
29.39	63.5	63.85	62.32

For case I, the resistivity is calculated using an effective Nordheim coefficient (C_{eff}) and for the second case the combined Nordheim–Matthiessens rule is scaled up by $(1 + X)$. It is observed that the values obtained by the later method is closer to the experimental results supporting the method of scaling taking into consideration the number of electrons donated by the solute atoms.

Comment: The Nordheim rule assumes that as the alloy composition changes, the number of conduction electrons per metal atom stays the same. In general, the resistivity due to the introduction of solute atoms (impurities) can be written as (see, for example, H. A. Fairbank, *Phys. Rev.* **66**, 274, 1944; see p278.)

$$\rho_I \propto \frac{N_{\text{at}}^{1/3}}{n^{2/3}} X(1-X)$$

where N_{at} = atomic concentration (roughly constant) and n = average number of conduction electrons per atom. These two terms arise from the fact that scattering from the impurities involves something called the density of states $g(E_F)$ which depends on the electron concentration. n will depend on the valency of the solute atom. We can now plot

$$\rho_{\text{brass}} = \rho_o + C \frac{X(1-X)}{(1+X)^{2/3}}$$

The plot of ρ vs. $X(1-X)/(1+X)^{2/3}$ is shown in Figure 2Q10-3. The fit is comparable to the intuitive and classical modification of Nordheim's rule in Figure 2Q10-2.

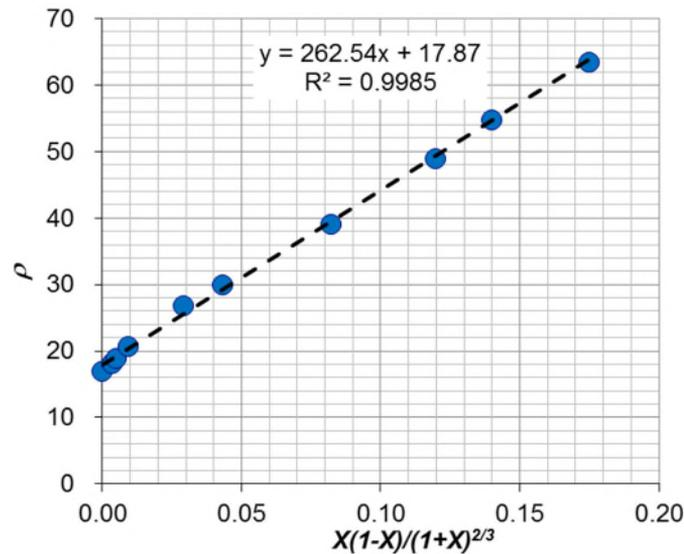

Figure 2Q10-3: Plot of ρ against $X(1-X)/(1+X)^{2/3}$

2.11 Resistivity of solid solution metal alloys: testing Nordheim's rule Nordheim's rule accounts for the increase in the resistivity from the scattering of electrons from the random distribution of impurity (solute) atoms in the host (solvent) crystal. It can nonetheless be quite useful in approximately predicting the resistivity at one composition of a solid solution metal alloy, given the value at another composition. Table 2.12 lists some solid solution metal alloys and gives the resistivity ρ at one composition X and asks for a prediction ρ' based on Nordheim's rule at another composition X' . Fill in the table for ρ' and compare the predicted values with the experimental values, and comment.

Table 2.12 Resistivities of some solid solution metal alloys

	Alloy							
	Ag–Au	Au–Ag	Cu–Pd	Ag–Pd	Au–Pd	Pd–Pt	Pt–Pd	Cu–Ni
X (at.%)	8.8% Au	8.77% Ag	6.2% Pd	10.1% Pd	8.88% Pd	7.66% Pt	7.1% Pd	2.16% Ni
ρ_0 (n Ω m)	16.2	22.7	17	16.2	22.7	108	105.8	17
ρ at X (n Ω m)	44.2	54.1	70.8	59.8	54.1	188.2	146.8	50
C_{eff}								
X'	15.4% Au	24.4% Ag	13% Pd	15.2% Pd	17.1% Pd	15.5% Pt	13.8% Pd	23.4% Ni
ρ' at X' (n Ω m)								
ρ' at X' (n Ω m)	66.3	107.2	121.6	83.8	82.2	244	181	300
Experimental								

NOTE: First symbol (e.g., Ag in AgAu) is the matrix (solvent) and the second (Au) is the added solute. X is in at.%, converted from traditional weight percentages reported with alloys. C_{eff} is the effective Nordheim coefficient in $\rho = \rho_0 + C_{\text{eff}} X(1 - X)$.

Solution

Combined Matthiessen and Nordheim rule is

$$\rho_{\text{alloy}} = \rho_0 + C_{\text{eff}} X(1 - X)$$

therefore, from the above equation effective Nordheim coefficient C_{eff} is

$$C_{\text{eff}} = \frac{\rho_{\text{alloy}} - \rho_0}{X(1 - X)}$$

Ag-Au:

For this alloy, it is given that for $X = 8.8\%$ Au, $\rho = 44.2 \text{ n}\Omega \text{ m}$, with $\rho_0 = 16.2 \text{ n}\Omega \text{ m}$, the effective Nordheim coefficient C_{eff} is

$$C_{\text{eff}} = \frac{(44.2 - 16.2) \text{ n}\Omega \text{ m}}{0.088 \times (1 - 0.088)} = 348.89 \text{ n}\Omega \text{ m}$$

Now, for $X' = 15.4\%$ Au, the resistivity of the alloy will be

$$\rho' = 16.2 \text{ n}\Omega \text{ m} + (348.89 \text{ n}\Omega \text{ m})(0.154)(1 - 0.154) = 61.65 \text{ n}\Omega \text{ m}$$

Similarly, the effective Nordheim coefficient C_{eff} and the resistivities of the alloys at X' are calculated for the various alloys and tabulated as follows,

Table 2Q11-1: Resistivities of solid solution metal alloys

	Alloy							
	Ag-Au	Au-Ag	Cu-Pd	Ag-Pd	Au-Pd	Pd-Pt	Pt-Pd	Cu-Ni
X (at.%)	8.8% Au	8.77% Ag	6.2% Pd	10.1% Pd	8.88% Pd	7.66% Pt	7.1% Pd	2.16% Ni
ρ_0 (nΩ m)	16.2	22.7	17	16.2	22.7	108	105.8	17
ρ at X (nΩ m)	44.2	54.1	70.8	59.8	54.1	188.2	146.8	50
C_{eff}	348.88	392.46	925.10	480.18	388.06	1133.85	621.60	1561.51
X'	15.4% Au	24.4% Ag	13% Pd	15.2% Pd	17.1% Pd	15.5% Pt	13.8% Pd	23.4% Ni
ρ' at X' (nΩ m)	61.65	95.09	121.63	78.09	77.71	256.51	179.74	296.89
ρ' at X' (nΩ m) Experimental	66.3	107.2	121.6	83.8	82.2	244	181	300
Percentage Difference	7.01% less	11.29% less	0.02% more	6.81% less	5.46% less	4.88% more	0.69% less	1.04% less

Comment: From the above table, the best case has a 0.02% difference and the worst case has a 7% difference. It is clear that the Nordheim rule is very useful in predicting the approximate resistivity of a solid solution at one composition from the resistivity at a known composition.

***2.12 TCR and alloy resistivity** Table 2.13 shows the resistivity and TCR (α) of Cu–Ni alloys. Plot TCR versus $1/\rho$, and obtain the best-fit line. What is your conclusion? Consider the Matthiessen rule, and explain why the plot should be a straight line. What is the relationship between ρ_{Cu} , α_{Cu} , ρ_{CuNi} , and α_{CuNi} ? Can this be generalized?

Table 2.13 Cu-Ni alloys, resistivity and TCR

	Ni wt.% in Cu–Ni				
	0	2	6	11	20
Resistivity (n Ω m)	17	50	100	150	300
TCR (ppm $^{\circ}\text{C}^{-1}$)	4270	1350	550	430	160

NOTE: ppm-parts per million, i.e. 10^{-6} .

Solution

We can first construct a table as shown Table 2Q12-1.

Table 2Q12-1 Resistivity and TCR values

Resistivity	$1/\rho$	TCR (ppm 1/C)	TCR (1/C)
17	0.058824	4270	0.00427
50	0.02	1350	0.00135
100	0.01	550	0.00055
150	0.006667	430	0.00043
300	0.003333	160	0.00016

The plot of temperature coefficient of resistivity TCR (α) versus $1/\rho$ is shown in Figure 2Q12-1, and clearly we can fit a linear relationship with an excellent R^2 value, 0.9991. Further, on a log-log plot, shown in Figure 2Q12-2, we can fit a power law dependence of the form

$$\alpha_{\text{alloy}} \propto \frac{1}{\rho_{\text{alloy}}^n}$$

in which $n = 1.13$, again very close to our expectation $\alpha_{\text{alloy}} \propto \rho_{\text{alloy}}^{-1}$. Notice that the linear dependence in Figure 2Q12-1 gives a better R^2 .

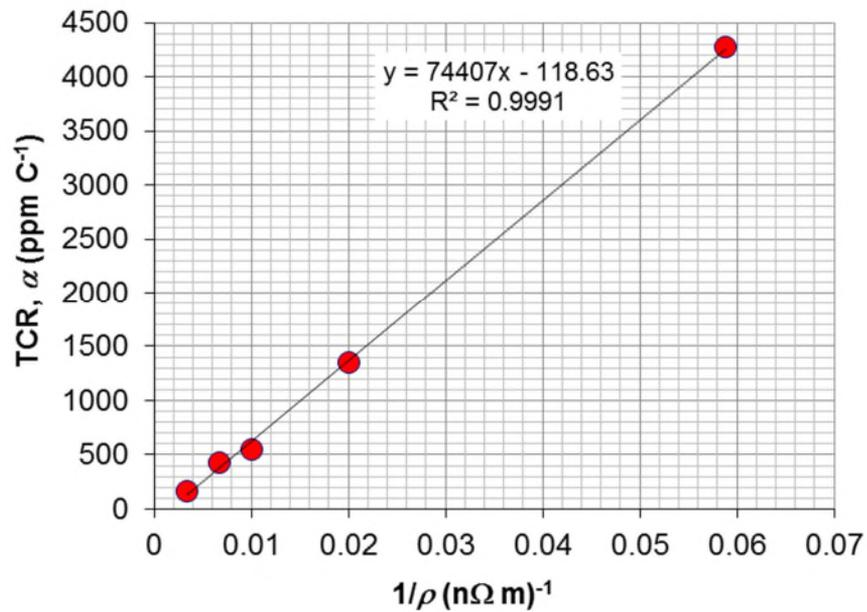

Figure 2Q12-1: TCR (α) versus reciprocal of resistivity $1/\rho$

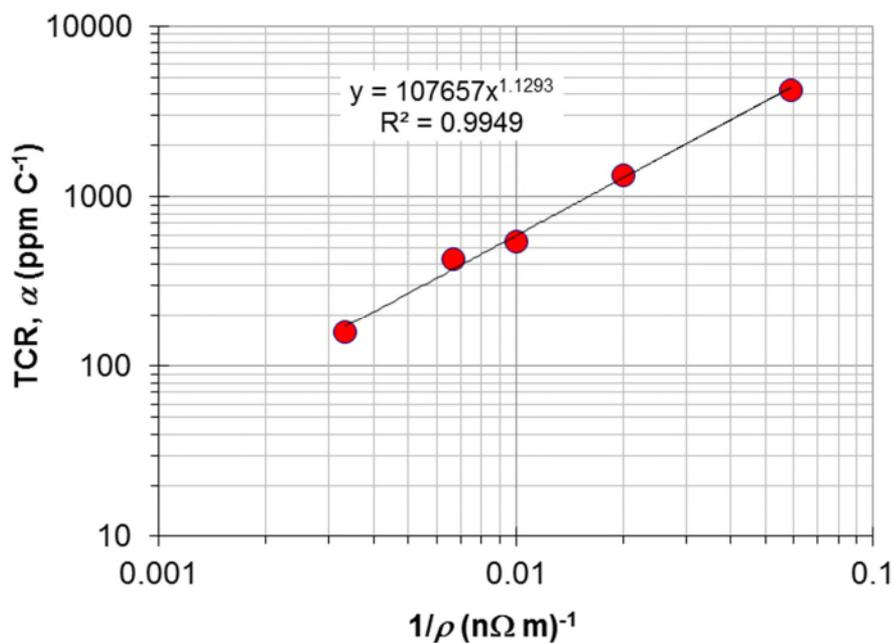

Figure 2Q12-2: TCR (α) versus reciprocal of resistivity $1/\rho$ on a log-log plot

From Matthiessen's rules, we have

$$\rho_{\text{alloy}} = \rho_{\text{matrix}} + \rho_I = \rho_o + \rho_I$$

where ρ_o is the resistivity of the matrix, determined by scattering of electrons by thermal vibrations of crystal atoms and ρ_I is the resistivity due to scattering of electrons from the impurities. Obviously, ρ_o is a function of temperature, but ρ_I shows very little temperature dependence. From the definition of temperature coefficient of resistivity,

$$\alpha_o = \frac{1}{\rho_o} \left(\frac{\delta \rho_o}{\delta T} \right) \quad \text{or} \quad \frac{\delta \rho_o}{\delta T} = \alpha_o \rho_o$$

and

$$\alpha_{\text{alloy}} = \frac{1}{\rho_{\text{alloy}}} \left(\frac{\delta \rho_{\text{alloy}}}{\delta T} \right) = \frac{\delta(\rho_o + \rho_l)}{\rho_{\text{alloy}} \delta T} \approx \frac{\delta \rho_o}{\rho_{\text{alloy}} \delta T} = \frac{\alpha_o \rho_o}{\rho_{\text{alloy}}} \propto \frac{1}{\rho_{\text{alloy}}}$$

Clearly the TCR of the alloy is inversely proportional to the resistivity of the alloy. The higher the resistivity, the smaller the TCR, which is evident from the plot.

2.13 Hall effect measurements The resistivity and the Hall coefficient of pure aluminum and Al with 1 at.% Si have been measured at at 20 °C (293 K) as $\rho = 2.65 \mu\Omega \text{ cm}$, $R_H = -3.51 \times 10^{-11} \text{ m}^3 \text{ C}^{-1}$ for Al and $\rho = 3.33 \mu\Omega \text{ cm}$, $R_H = -3.16 \times 10^{-11} \text{ m}^3 \text{ C}^{-1}$ for 99 at.% Al-1 at% Si. The lattice parameters for the pure metal and the alloy are 0.4049 nm and 0.4074 nm. What does the simple Drude model predict for the drift mobility in these two metals? How many conduction electrons are there per atom? (Data from M Bradley and John Stringer, *J.Phys. F: Metal Phys.*, **4**, 839, 1974)

Solution

I. Consider the pure Al crystal

The Hall coefficient is given by

$$R_H = -\frac{1}{en}$$

$$\therefore n = -\frac{1}{eR_H} = -\frac{1}{(1.602 \times 10^{-19} \text{ C})(-3.51 \times 10^{-11} \text{ m}^3 \text{ C}^{-1})} = 1.778 \times 10^{29} \text{ m}^{-3}.$$

The conductivity can be used to find the drift mobility

$$\frac{1}{\rho} = en\mu_d$$

$$\therefore \mu_d = \frac{1}{en\rho} = \frac{1}{(1.602 \times 10^{-19} \text{ C})(1.778 \times 10^{29} \text{ m}^{-3})(2.65 \times 10^{-8} \Omega \text{ m})} = 0.00133 \text{ m}^2 \text{ V}^{-1} \text{ s}^{-1}$$

or $\mu_d = 13.3 \text{ cm}^2 \text{ V}^{-1} \text{ s}^{-1}$.

We can also find the number x of conduction electrons per Al atom. The atomic concentration in Al is

$$n_{\text{at}} = \frac{4 \text{ atoms in FCC cell}}{a^3} = \frac{4 \text{ atoms in FCC cell}}{(0.4049 \times 10^{-9} \text{ m})^3} = 6.026 \times 10^{28} \text{ m}^{-3}$$

$$\therefore x = \frac{n}{n_{\text{at}}} = \frac{1.778 \times 10^{29} \text{ m}^{-3}}{6.026 \times 10^{28} \text{ m}^{-3}} = 2.95$$

very close to the valency of Al.

II. Consider the 99%Al-1%Si crystal

We can repeat all the above calculations as follows:

$$n = -\frac{1}{eR_H} = -\frac{1}{(1.602 \times 10^{-19} \text{ C})(-3.16 \times 10^{-11} \text{ m}^3 \text{ C}^{-1})} = 1.975 \times 10^{29} \text{ m}^{-3}.$$

and

$$\mu_d = \frac{1}{en\rho} = \frac{1}{(1.602 \times 10^{-19} \text{ C})(1.975 \times 10^{29} \text{ m}^{-3})(3.16 \times 10^{-8} \text{ }\Omega\text{m})} = 0.000949 \text{ m}^2 \text{ V}^{-1} \text{ s}^{-1}$$

or $\mu_d = 9.49 \text{ cm}^2 \text{ V}^{-1} \text{ s}^{-1}$

As expected the drift mobility in this sample is lower due to scattering from Si impurities.

We can also find the number x of conduction electrons per Al atom. The atomic concentration in Al is

$$n_{\text{at}} = \frac{4 \text{ atoms in FCC cell}}{a^3} = \frac{4 \text{ atoms in FCC cell}}{(0.4074 \times 10^{-9} \text{ m})^3} = 5.916 \times 10^{28} \text{ m}^{-3}$$

$$\therefore x = \frac{n}{n_{\text{at}}} = \frac{1.975 \times 10^{29} \text{ m}^{-3}}{5.916 \times 10^{28} \text{ m}^{-3}} = 3.31$$

which is 10% higher than the expected valency.

The lower drift mobility in the Si-1% C crystal is in agreement with the predictions of the Drude model and the Matthiessen's rule.

Note: The Hall coefficient in general is given by

$$R_H = -\frac{r}{en}$$

where r is a numerical factor, called the Hall factor, that describes how the electrons are scattered in the crystal. It was taken as 1 in the simple theory above. Generally it is between 1 and 2, and depends on the scattering mechanisms. Unfortunately there is no information on r for the two materials but it should be clear that r would not be the same.

2.14 Hall effect and the Drude model, Table 2.14 shows the experimentally measured Hall coefficient and resistivities for various metals and their position in the periodic table. (a) Calculate the Hall mobility for each element. (b) Calculate the conduction electron concentration from the experimental value of R_H . (c) Find how many electrons per atom are contributed to the conduction electron gas in the metal per metal atom. What is your conclusion?

Table 2.14 Measured Hall coefficients for a few metals at 25 °C

	Li	Na	K	Cs	Cu	Ag	Au	Ca	Mg	Zn	Al	In
Group	I	I	I	I	IB	IB	IB	IIA	IIA	IIB	III	III
R_H ($\times 10^{-11} \text{ m}^3 \text{ C}^{-1}$)	-15	-24.8	-42.8	-73.3	-5.4	-9.0	-7.2	-17.8	-8.3	+10.4	-3.4	-7.0
ρ (n Ω m)	92.8	48.8	73.9	208	17.1	16.7	22.6	33.6	44.8	60.1	27.1	83.7

Note: Data from various sources combined, including C. Hurd, *The Hall Coefficient of Metals and Alloys*, Plenum, New York, 1972.

Solution

Consider Li, the first element in Group I.

(a) Consider the magnitude of the conductivity product with R_H ,

$$|\sigma R_H| = \left| (en\mu_d) \left(\frac{-1}{en} \right) \right| = \mu_d$$

The drift mobility μ_d here is called the Hall mobility μ_H due to the fact that it is found through the product of the Hall coefficient and conductivity.

$$\mu_H = |\sigma R_H| = \frac{|R_H|}{\rho} = \frac{15 \times 10^{-11} \text{ m}^3 \text{ C}^{-1}}{92.8 \times 10^{-9} \text{ } \Omega \text{ m}} = 1.62 \times 10^{-3} \text{ m}^2 \text{ V}^{-1} \text{ s}^{-1} = 16.2 \text{ cm}^2 \text{ V}^{-1} \text{ s}^{-1}$$

(b) From the equations for R_H , we have

$$n = -\frac{1}{eR_H} = -\frac{1}{(1.602 \times 10^{-19} \text{ C})(-15 \times 10^{-11} \text{ m}^3 \text{ C}^{-1})} = 4.161 \times 10^{28} \text{ m}^{-3}.$$

(c) We can get its density and atomic mass from the Appendix at the end of the textbook. If D is the density, M_{at} is the atomic mass and N_A is Avogadro's number, then the atomic concentration n_{at} is

$$n_{\text{at}} = \frac{DN_A}{M_{\text{at}}} = \frac{(540 \text{ kg m}^{-3})(6.022 \times 10^{23} \text{ mol}^{-1})}{(6.94 \times 10^{-3} \text{ kg mol}^{-1})} = 4.686 \times 10^{28} \text{ m}^{-3}$$

We can calculate the number of electrons per Li atom that is in the electron gas as follows

$$x = \frac{n}{n_{\text{at}}} = \frac{4.161 \times 10^{28} \text{ m}^{-3}}{4.686 \times 10^{28} \text{ m}^{-3}} = 0.89$$

This is close to 1, the valency of Li. The difference is only 11%. Table 2Q14-1 lists the calculations for other elements in Table 2.14.

Conclusions:

The basic idea is "How good is the simple Drude model?"

- (1) Group I elements, Li, Na, K, Cs are very close to expected Drude model values with x close to the valency 1; $x = 0.89 - 1.10$
- (2) Group IB, Ag, Cu, Au, have $x = 1.18 - 1.47$. Although there is a clear deviation from the Drude model by as much as 47%, the sign is correct and the magnitude is very roughly correct, within 47%
- (3) Mg, from IIA, has a valency of 2. R_H gives $x = 1.74$ and the difference is only 26%, again the Drude model is not bad.
- (4) Zn is a metal and in Group IIB. The Drude model is a total failure as the sign is wrong.
- (5) Ca from Group IIA has $x = 1.52$. The sign is right and the magnitude is very roughly right to within 49%
- (6) Group III with Al and In, we find $x = 2.33$ (In) – 3.05 (Al). The Drude model again is successful in predicting the sign and a rough value for the magnitude, within 67%.
- (7) The Drude model works best with Group I elements (Li, Na, K, Cs) and in certain cases such as Zn it totally fails.

Table 2Q14-1 Calculations from Hall coefficient and conductivity

N_A	6E+23			$q =$	1.6E-19						
		g/mole	g/cm ³	1/m ³	EXPERIMENT	1/m ³				nΩ m	m ² /Vs
Valency	Metal	Mat	Density	nat	RH x 1E-11	n from RH	x		Difference (%)	Resistivity	Hall mobility
1	Li	6.94	0.54	4.686E+28	-15	4.161E+28	0.89		11.2	92.8	16.16
1	Na	22.99	0.968	2.536E+28	-24.8	2.517E+28	0.99		0.7	48.8	50.82
1	K	39.10	0.862	1.328E+28	-42.8	1.458E+28	1.10		-9.8	73.9	57.92
1	Cs	132.91	1.93	8.745E+27	-73.3	8.516E+27	0.97		2.6	208	35.24
1	Ag	107.87	10.49	5.856E+28	-9	6.936E+28	1.18		-18.4	16.7	53.89
1	Cu	63.55	8.96	8.491E+28	-5.4	1.156E+29	1.36		-36.1	17.1	31.58
1	Au	196.97	19.3	5.901E+28	-7.2	8.670E+28	1.47		-46.9	22.6	31.86
2	Mg	24.31	1.74	4.311E+28	-8.3	7.521E+28	1.74		25.6	44.8	18.53
2	Zn	65.38	7.13	6.567E+28	10.4	6.002E+28	-0.91		291.4	60.1	17.30
2	Ca	40.08	1.54	2.314E+28	-17.8	3.507E+28	1.52		48.5	33.6	52.98
3	Al	26.98	2.7	6.026E+28	-3.4	1.836E+29	3.05		-4.7	27.1	12.55
3	In	114.82	7.31	3.834E+28	-7	8.917E+28	2.33		67.4	83.7	8.36

2.15 The Hall effect Consider a rectangular sample, a metal or an *n*-type semiconductor, with a length *L*, width *W*, and thickness *D*. A current *I* is passed along *L*, perpendicular to the cross-sectional area *WD*. The face *W* × *L* is exposed to a magnetic field density *B*. A voltmeter is connected across the width, as shown in Figure 2.40, to read the Hall voltage *V_H*.

a. Show that the Hall voltage recorded by the voltmeter is

$$V_H = \frac{IB}{Den} \quad \text{Hall voltage}$$

b. Consider a 1-micron-thick strip of gold layer on an insulating substrate that is a candidate for a Hall probe sensor. If the current through the film is maintained at constant 100 mA, what is the magnetic field that can be recorded per μV of Hall voltage?

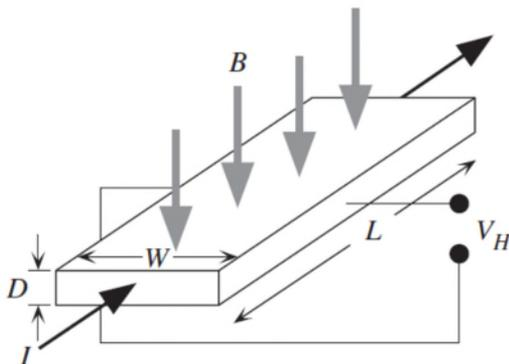

Figure 2.40 Hall effect in a rectangular material with length *L*, width *W*, and thickness *D*. The voltmeter is across the width *W*.

Solution

a. The Hall coefficient, R_H , is related to the electron concentration, n , by $R_H = -1 / (en)$, and is defined by $R_H = E_y / (JB)$, where E_y is the electric field in the y -direction, J is the current density and B is the magnetic field. Equating these two equations:

$$-\frac{1}{en} = \frac{E_y}{JB}$$

$$\therefore E_y = -\frac{JB}{en}$$

This electric field is in the opposite direction of the Hall field (E_H) and therefore:

$$E_H = -E_y = \frac{JB}{en} \quad (1)$$

The current density perpendicular (going through) the plane $W \times D$ (width by depth) is:

$$J = \frac{I}{WD}$$

$$\therefore W = \frac{I}{JD} \quad (2)$$

The Hall voltage (V_H) across W is:

$$V_H = WE_H$$

If we substitute expressions (1) and (2) into this equation, the following will be obtained:

$$V_H = \frac{IB}{Den}$$

Note: this expression only depends on the thickness and not on the length of the sample.

In general, the Hall voltage will depend on the specimen shape. In the elementary treatment here, the current flow lines were assumed to be nearly parallel from one end to the other end of the sample. In an irregularly shaped sample, one has to consider the current flow lines. However, if the specimen thickness is uniform, it is then possible to carry out meaningful Hall effect measurements using the van der Pauw technique as discussed in advanced textbooks.

b. We are given the depth of the film $D = 1$ micron = $1 \mu\text{m}$ and the current through the film $I = 100$ mA = 0.1 A. The Hall voltage can be taken to be $V_H = 1 \mu\text{V}$, since we are looking for the magnetic field B per μV of Hall voltage. To be able to use the equation for Hall voltage in part (*a*), we must find the electron concentration of gold. Appendix *B* in the textbook contains values for gold's atomic mass ($M_{\text{at}} = 196.97 \text{ g mol}^{-1}$) and density ($d = 19.3 \text{ g/cm}^3 = 19300 \text{ kg/m}^3$). Since gold has a valency of 1 electron, the concentration of free electrons is equal to the concentration of Au atoms.

$$\therefore n = \frac{dN_A}{M_{\text{at}}} = \frac{(19300 \text{ kg m}^{-3})(6.022 \times 10^{23} \text{ mol}^{-1})}{(196.97 \times 10^{-3} \text{ kg mol}^{-1})} = 5.901 \times 10^{28} \text{ m}^{-3}$$

Now the magnetic field B can be found by using the equation for the Hall voltage:

$$V_H = \frac{IB}{Den}$$

$$\therefore B = \frac{V_H D e n}{I} = \frac{(1 \times 10^{-6} \text{ V})(1 \times 10^{-6} \text{ m})(1.602 \times 10^{-19} \text{ C})(5.901 \times 10^{28} \text{ m}^{-3})}{(0.1 \text{ A})}$$

$$\therefore B = 0.0945 \text{ T}$$

As a side note, the power (P) dissipated in the film could be found very easily. Using the value for resistivity of Au at $T = 273 \text{ K}$, $\rho = 22.8 \text{ n}\Omega \text{ m}$, the resistance of the film is:

$$R = \frac{\rho L}{A} = \frac{\rho L}{WD} = \frac{(22.8 \times 10^{-9} \Omega \text{ m})(0.001 \text{ m})}{(0.0001 \text{ m})(1 \times 10^{-6} \text{ m})} = 0.228 \Omega$$

The power dissipated is then:

$$P = I^2 R = (0.1 \text{ A})^2 (0.228 \Omega) = 0.00228 \text{ W}$$

2.16 Electrical and thermal conductivity of In Electron drift mobility in indium has been measured to be $6 \text{ cm}^2 \text{ V}^{-1} \text{ s}^{-1}$. The room temperature ($27 \text{ }^\circ\text{C}$) resistivity of In is $8.37 \times 10^{-8} \Omega \text{ m}$, and its atomic mass and density are 114.82 amu or g mol^{-1} and 7.31 g cm^{-3} , respectively.

- Based on the resistivity value, determine how many free electrons are donated by each In atom in the crystal. How does this compare with the position of In in the Periodic Table (Group IIIB)?
- If the mean speed of conduction electrons in In is $1.74 \times 10^8 \text{ cm s}^{-1}$, what is the mean free path?
- Calculate the thermal conductivity of In. How does this compare with the experimental value of $81.6 \text{ W m}^{-1} \text{ K}^{-1}$?

Solution

a. From $\sigma = en\mu_d$ (σ is the conductivity of the metal, e is the electron charge, and μ_d is the electron drift mobility) we can calculate the concentration of conduction electrons (n):

$$n = \frac{\sigma}{e\mu_d} = \frac{(8.37 \times 10^{-8} \Omega \text{ m})^{-1}}{(1.602 \times 10^{-19} \text{ C})(6 \times 10^{-4} \text{ m}^2 \text{ V}^{-1} \text{ s}^{-1})}$$

$$\text{i.e. } n = 1.243 \times 10^{29} \text{ m}^{-3}$$

Atomic concentration n_{at} is

$$n_{\text{at}} = \frac{dN_A}{M_{\text{at}}} = \frac{(7.31 \times 10^3 \text{ kg m}^{-3})(6.022 \times 10^{23} \text{ mol}^{-1})}{(114.82 \times 10^{-3} \text{ kg mol}^{-1})}$$

$$\text{i.e. } n_{\text{at}} = 3.834 \times 10^{28} \text{ m}^{-3}$$

Effective number of conduction electrons donated per In atom (n_{eff}) is:

$$n_{\text{eff}} = n / n_{\text{at}} = (1.243 \times 10^{29} \text{ m}^{-3}) / (3.834 \times 10^{28} \text{ m}^{-3}) = \mathbf{3.24}$$

Conclusion: Within the classical theory of metals, this would imply that about three electrons per atom are donated to the conduction-electron sea in the metal. This is in good agreement with the position of the In element in the Periodic Table (III) and its valency of 3.

b. If τ is the mean scattering time of the conduction electrons, then from $\mu_d = e\tau/m_e$ (m_e = electron mass) we have:

$$\tau = \frac{\mu_d m_e}{e} = \frac{(6 \times 10^{-4} \text{ m}^2 \text{ V}^{-1} \text{ s}^{-1})(9.109 \times 10^{-31} \text{ kg})}{(1.602 \times 10^{-19} \text{ C})} = 3.412 \times 10^{-15} \text{ s}$$

Taking the mean speed $u \approx 1.74 \times 10^6 \text{ m s}^{-1}$, the mean free path (l) is given by

$$l = u\tau = (1.74 \times 10^6 \text{ m s}^{-1})(3.412 \times 10^{-15} \text{ s}) = 5.94 \times 10^{-9} \text{ m or } 5.94 \text{ nm}$$

One can estimate the interatomic separation d from

$$d \approx \frac{1}{n_{\text{at}}^{1/3}} = \frac{1}{(3.83 \times 10^{28} \text{ m}^{-3})^{1/3}} = 0.3 \text{ nm}$$

which means that $l = 20d$. The electrons passes ~ 20 atoms before it is scattered.

c. From the Wiedemann-Franz-Lorenz law, thermal conductivity is given as:

$$\kappa = \sigma T C_{\text{WFL}} = (8.37 \times 10^{-8} \text{ } \Omega \text{ m})^{-1} (27 \text{ }^\circ\text{C} + 273 \text{ K}) (2.44 \times 10^{-8} \text{ W } \Omega \text{ K}^{-2})$$

i.e. $\kappa = 85.4 \text{ W m}^{-1} \text{ K}^{-1}$

This value reasonably agrees with the experimental value.

Note: Indium has a body-centered tetragonal crystal structure and the lattice constants are $a = b = 0.325 \text{ nm}$ and $c = 0.494 \text{ nm}$. The atomic concentration is therefore $n_{\text{at}} = 2/abc = 3.83 \times 10^{28} \text{ m}^{-3}$, which is the same as $n_{\text{at}} = dN_A/M_{\text{at}}$ (as we know from Ch. 1).

2.17 Electrical and thermal conductivity of Ag The electron drift mobility in silver has been measured to be $54 \text{ cm}^2 \text{ V}^{-1} \text{ s}^{-1}$ at $27 \text{ }^\circ\text{C}$. The atomic mass and density of Ag are given as 107.87 amu or g mol^{-1} and 10.50 g cm^{-3} , respectively.

- Assuming that each Ag atom contributes one conduction electron, calculate the resistivity of Ag at $27 \text{ }^\circ\text{C}$. Compare this value with the measured value of $1.6 \times 10^{-8} \text{ } \Omega \text{ m}$ at the same temperature and suggest reasons for the difference.
- Calculate the thermal conductivity of silver at $27 \text{ }^\circ\text{C}$ and at $0 \text{ }^\circ\text{C}$.

Solution

a. Atomic concentration n_{at} is

$$n_{\text{at}} = \frac{dN_A}{M_{\text{at}}} = \frac{(10.50 \times 10^3 \text{ kg m}^{-3})(6.022 \times 10^{23} \text{ mol}^{-1})}{(107.87 \times 10^{-3} \text{ kg mol}^{-1})} = 5.862 \times 10^{28} \text{ m}^{-3}$$

If we assume there is one conduction electron per Ag atom, the concentration of conduction electrons (n) is $5.862 \times 10^{28} \text{ m}^{-3}$, and the conductivity is therefore:

$$\sigma = en\mu_d = (1.602 \times 10^{-19} \text{ C})(5.862 \times 10^{28} \text{ m}^{-3})(54 \times 10^{-4} \text{ m}^2 \text{ V}^{-1} \text{ s}^{-1}) = 5.071 \times 10^7 \text{ } \Omega^{-1} \text{ m}^{-1}$$

and the resistivity, $\rho = 1/\sigma = 19.7 \text{ n}\Omega \text{ m}$

The experimental value of ρ is $16 \text{ n}\Omega \text{ m}$. We assumed that exactly 1 "free" electron per Ag atom contributes to conduction. This may not necessarily be true.

Note: More importantly, the difference is part of the failure of classical physics. Some of this will be apparent in Ch. 4 where energy bands are used for conduction.

b. From the Wiedemann-Franz-Lorenz law at 27 °C,

$$\kappa = \sigma T C_{\text{WFL}} = (5.259 \times 10^7 \Omega^{-1} \text{ m}^{-1})(27 + 273 \text{ K})(2.44 \times 10^{-8} \text{ W } \Omega \text{ K}^{-2})$$

i.e. $\kappa = 385 \text{ W m}^{-1} \text{ K}^{-1}$ (at 27 °C and 0 °C)

For pure metals such as Ag this is nearly independent of temperature (same at 0 °C).

2.18 Mixture rules A 70% Cu - 30% Zn brass electrical component has been made of powdered metal and contains 15 vol. % porosity. Assume that the pores are dispersed randomly. Given that the resistivity of 70% Cu-30% Zn brass is 62 nΩ m, calculate the effective resistivity of the brass component using the simple conductivity mixture rule, Equation 2.26 and the Reynolds and Hough rule.

Solution

The component has 15% air pores, which is the dispersed phase. Apply the empirical mixture rule in Equation 2.32. The fraction of volume with air pores is $\chi_d = 0.15$. Then,

$$\rho_{\text{eff}} = \rho \frac{(1 + \frac{1}{2} \chi_d)}{(1 - \chi_d)} = 62 \text{ n}\Omega \text{ m} \frac{(1 + 0.5 \times 0.15)}{(1 - 0.15)} = \mathbf{78.41 \text{ n}\Omega \text{ m}}$$

Reynolds and Hough rule is given by Equation 2.34 as

$$\frac{\sigma - \sigma_{\text{alloy}}}{\sigma + 2\sigma_{\text{alloy}}} = \chi \frac{\sigma_{\text{air}} - \sigma_{\text{alloy}}}{\sigma_{\text{air}} + 2\sigma_{\text{alloy}}}$$

For the given case $\sigma_{\text{air}} = 0$, $\sigma_{\text{alloy}} = (62 \text{ n}\Omega \text{ m})^{-1}$. Substituting the conductivity values in the RHS of the equation we have

$$\chi \frac{\sigma_{\text{air}} - \sigma_{\text{alloy}}}{\sigma_{\text{air}} + 2\sigma_{\text{alloy}}} = (0.15) \left(\frac{0 - (62 \text{ n}\Omega \text{ m})^{-1}}{0 + 2(62 \text{ n}\Omega \text{ m})^{-1}} \right) = -0.075.$$

Solving for effective conductivity, we have $\sigma = 1.2753 \times 10^7 \Omega^{-1} \text{ m}^{-1}$

$\therefore \rho_{\text{eff}} = 78.41 \times 10^{-9} \Omega \text{ m}$ or 78.41 nΩ m.

Hence the values obtained are the same. Equation 2.32 is in fact the simplified version of Reynolds and Hough rule for the case when the resistivity of dispersed phase is considerably larger than the continuous phase.

2.19 Mixture rules

- A certain carbon electrode used in electrical arcing applications is 47 percent porous. Given that the resistivity of graphite (in polycrystalline form) at room temperature is about 9.1 μΩ m, estimate the effective resistivity of the carbon electrode using the appropriate Reynolds and Hough rule and the simple conductivity mixture rule. Compare your estimates with the measured value of 18 μΩ m and comment on the differences.
- Silver particles are dispersed in a graphite paste to increase the effective conductivity of the paste. If the volume fraction of dispersed silver is 30 percent, what is the effective conductivity of this paste?

Solution

a. The effective conductivity of mixture can be estimated using Reynolds and Hough rule in Equation 2.34, which is

$$\frac{\sigma - \sigma_c}{\sigma + 2\sigma_c} = \chi \frac{\sigma_d - \sigma_c}{\sigma_d + 2\sigma_c}$$

If the conductivity of the dispersed medium is very small compared to the continuous phase, as in the given case conductivity of pores is extremely small compared to polycrystalline carbon, i.e. $\sigma_c \gg \sigma_d$. Equation 2.32 is the simplified version of Reynolds and Hough rule.

The volume fraction of air pores is $\chi = 0.47$ and the conductivity of graphite is $\rho_c = 9.1 \mu\Omega \text{ m}$, therefore

$$\rho_{\text{eff}} = \rho_c \frac{(1 + \frac{1}{2} \chi_d)}{(1 - \chi_d)} = (9.1 \mu\Omega \text{ m}) \frac{(1 + 0.5 \times 0.47)}{(1 - 0.47)} = 21.21 \mu\Omega \text{ m}$$

Conductivity mixture rule is based on the assumption that the two phases α and β are parallel to each other and the effective conductivity from Equation 2.31 is

$$\sigma_{\text{eff}} = \chi_\alpha \sigma_\alpha + \chi_\beta \sigma_\beta$$

For the given situation $\chi_{\text{air}} = 0.47$, $\chi_{\text{graphite}} = (1 - 0.47)$, $\sigma_{\text{air}} = 0$, $\sigma_{\text{graphite}} = (9.1 \mu\Omega \text{ m})^{-1}$, therefore the effective resistivity using the conductivity mixture rule is

$$\frac{1}{\rho_{\text{eff}}} = \frac{(1 - 0.47)}{9.1 \mu\Omega \text{ m}} + 0$$

$$\therefore \rho_{\text{eff}} = 17.17 \mu\Omega \text{ m}$$

which is not as good as Equation 2.34. We cannot use the resistivity mixture rule. (ρ_{eff} goes to infinity)

b. If the dispersed phase has higher conductivity than the continuous phase, the Reynolds and Hough rule is reduced to Equation 2.33. From Table 2.1, resistivity for silver at 273 K is 14.7 nΩ m. Using $\alpha_0 = 1/242 \text{ K}^{-1}$, the resistivity at room temperature (20°C) can be calculated as

$$\rho = \rho_0 [1 + \alpha_0 (T - T_0)] = (14.7 \text{ n}\Omega \text{ m}) \left[1 + \frac{1}{242} \text{ K}^{-1} (293 \text{ K} - 273 \text{ K}) \right] = 15.91 \text{ n}\Omega \text{ m}$$

Since $\rho_d < 0.1\rho_c$, we can try first Equation 2.33 as a first approximation. Volume fraction of dispersed silver is 30%, $\chi_d = 0.3$. The effective resistivity is

$$\rho_{\text{eff}} = \rho_c \frac{(1 - \chi_d)}{(1 + 2\chi_d)} = (9.1 \mu\Omega \text{ m}) \frac{(1 - 0.3)}{(1 + 2 \times 0.3)} = \mathbf{3.98 \mu\Omega \text{ m.}}$$

The resistivity of graphite is therefore reduced i.e. it is made more conducting. This rule works if $\rho_c > \rho_d/10$. Now, $\rho_c =$ resistivity of graphite = 9.1 μΩ m = 9100 nΩ m from part (a), which is much greater than 16.9 nΩ m for Ag, so the condition is satisfied. Indeed, we did not use ρ_d at all in this calculation!

In a more accurate calculation, we would use the Reynolds and Hough rule to calculate the effective resistivity. If σ is the effective conductivity ($1/\rho_{\text{eff}}$), then

$$\frac{\sigma - \sigma_c}{\sigma + 2\sigma_c} = \chi \frac{\sigma_d - \sigma_c}{\sigma_d + 2\sigma_c}$$

In terms of $\mu\Omega$ m units,

$$\frac{\sigma - (1/9.1)}{\sigma + 2(1/9.1)} = (0.3) \frac{[1/(15.9 \times 10^{-3})] - (1/9.1)}{[1/(15.9 \times 10^{-3})] + 2(1/9.1)}$$

which can be solved to find,

$$\rho_{\text{eff}} = 1/\sigma = \mathbf{3.99 \mu\Omega m}$$

very close to the approximation in Equation 2.33

Clearly, The approximate equation works well and we did not even need the resistivity of Ag in this case to find the effective resistivity.

2.20 Ag–Ni alloys (contact materials) and the mixture rules Silver alloys, particularly Ag alloys with the precious metals Pt, Pd, Ni, and Au, are extensively used as contact materials in various switches. Alloying Ag with other metals generally increases the hardness, wear resistance, and corrosion resistance at the expense of electrical and thermal conductivity. For example, Ag–Ni alloys are widely used as contact materials in switches in domestic appliances, control and selector switches, circuit breakers, and automotive switches up to several hundred amperes of current. Table 2.15 shows the resistivities of four Ag–Ni alloys used in make-and-break as well as disconnect contacts with current ratings up to ~100 A.

- Ag–Ni is a two-phase alloy, a mixture of Ag-rich and Ni-rich phases. Using an appropriate mixture rule, predict the resistivity of the alloy and compare with the measured values in Table 2.15. Explain the difference between the predicted and experimental values.
- Compare the resistivity of Ag–10% Ni with that of Ag–10% Pd in Table 2.12. The resistivity of the Ag–Pd alloy is almost a factor of 3 greater. Ag–Pd is an isomorphous solid solution, whereas Ag–Ni is a two-phase mixture. Explain the difference in the resistivities of Ag–Ni and Ag–Pd.

Table 2.15 Resistivity of Ag–Ni contact alloys for switches

	Ni % in Ag–Ni alloy						
	0	10	15	20	30	40	100
d (g cm ⁻³)	10.49	10.25	10.15	10.05	9.8	9.7	8.91
ρ (n Ω m)	16.9	18.7	19.0	20.0	24.4	27.0	71.0

NOTE: Compositions are in wt.%. Ag–10% Ni means 90% Ag–10% Ni. d = density and ρ = resistivity. Use volume fraction of Ni = $w_{\text{Ni}}(d_{\text{alloy}}/d_{\text{Ni}})$, where w_{Ni} is the Ni weight fraction, to convert wt.% to volume %. Data combined from various sources.

Solution

- The Ni contents are given in wt.%. For volume fraction we use the relation

$$\chi_{\text{Ni}} = \frac{w_{\text{Ni}}d}{d_{\text{Ni}}}$$

where w_{Ni} is the weight fraction of Ni, d_{Ni} is the density of Ni and, d is the density of the alloy mixture. For example, for Ni-30% wt. the volume fraction of Ni in the alloy will be

$$\chi_{\text{Ni}} = \frac{(0.3)(9.8 \times 10^3 \text{ kg m}^{-3})}{(8.91 \times 10^3 \text{ kg m}^{-3})} = 0.33$$

First we use Reynolds and Hough rule for mixture of dispersed phases to calculate the effective resistivity of the alloy. From Equation 2.28 we have

$$\frac{\sigma - \sigma_{\text{Ag}}}{\sigma + 2\sigma_{\text{Ag}}} = \chi_{\text{Ni}} \frac{\sigma_{\text{Ni}} - \sigma_{\text{Ag}}}{\sigma_{\text{Ni}} + 2\sigma_{\text{Ag}}}$$

Solving for Ni-30% wt., the R.H.S. of the above equation will be

$$= (0.33) \times \frac{(71.0 \text{ n}\Omega \text{ m})^{-1} - (16.9 \text{ n}\Omega \text{ m})^{-1}}{(71.0 \text{ n}\Omega \text{ m})^{-1} + 2(16.9 \text{ n}\Omega \text{ m})^{-1}} = -0.112 (\text{n}\Omega \text{ m})^{-1}$$

So that

$$\frac{\sigma - (16.9 \text{ n}\Omega \text{ m})^{-1}}{\sigma + 2(16.9 \text{ n}\Omega \text{ m})^{-1}} = -0.112 (\text{n}\Omega \text{ m})^{-1}$$

$$\therefore \sigma = 0.0412 (\text{n}\Omega \text{ m})^{-1}$$

$$\therefore \rho = 24.25 \text{ n}\Omega \text{ m.}$$

Substitute the calculated value in the Reynolds and Hough rule as above, to find the effective resistivity of the alloy, which is $\rho = 24.25 \text{ n}\Omega \text{ m}$. Similarly the resistivity of alloy with other Ni contents is calculated and is tabulated below in Table 2Q20-1.

We can see that the Reynolds Hough rule provides a reasonable estimate for the alloy resistivity with the discrepancy being 7.5% at worst case.

Table 2Q20-1 Resistivity of Ag-Ni contact alloys for switches

Ni % in Ag-Ni	d (g cm^{-3})	χ_{Ni}	ρ_{eff} (Reynolds & Hough) ($\text{n}\Omega \text{ m}$)	Experimental ($\text{n}\Omega \text{ m}$)	Discrepancy (%)
10	10.25	0.115	19.06	18.7	1.93
15	10.15	0.171	20.24	19.0	6.53
20	10.05	0.226	21.50	20.0	7.50
30	9.8	0.330	24.25	24.4	0.62
40	9.7	0.435	27.59	27.0	2.20

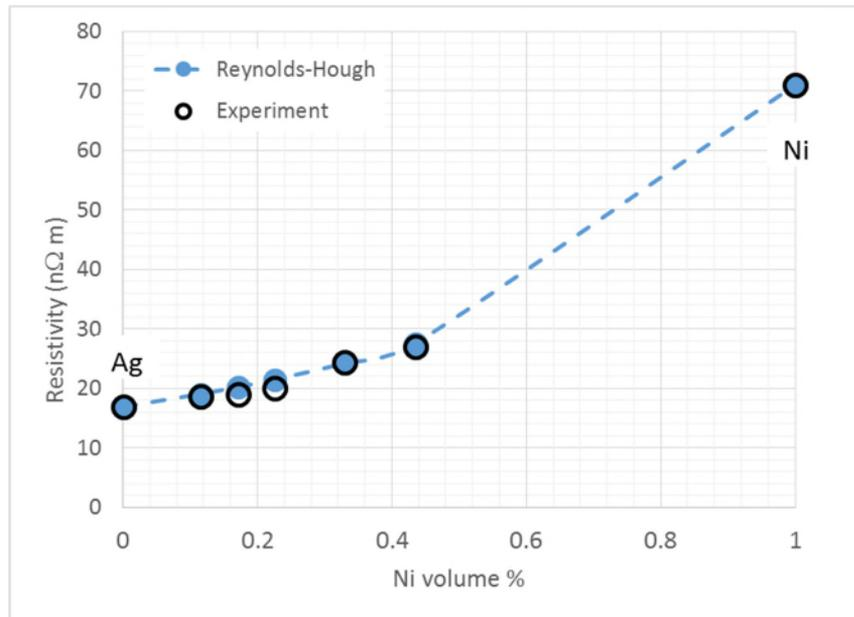

Figure 2Q20-1 Plot of effective and calculated resistivity for Ni-Ag alloys

b. 90% Ag-10% Ni, the solid is a mixture, and has two phases with an overall $\rho = 19.06 \text{ n}\Omega \text{ m}$. On the other hand 90% Ag-10% Pd, the solid is a solid solution with $\rho = 59.8 \text{ n}\Omega \text{ m}$, the value is roughly 3 times greater. The resistivity of a mixture is normally much lower than the resistivity of a *similar* solid solution. In a solid solution, the added impurities scatter electrons and increase the resistivity. In a mixture, each phase is almost like a "pure" metal, and the overall resistivity is simply an appropriate "averaging" or combination of the two resistivities.

Note: Data were extracted from <http://www.electrical-contacts-wiki.com>

12.21 Ag–W alloys (contact materials) and the mixture rule Silver–tungsten alloys are frequently used in heavy-duty switching applications (e.g., current-carrying contacts and oil circuit breakers) and in arcing tips. Ag–W is a two-phase alloy, a mixture of Ag-rich and W-rich phases. The measured resistivity and density for various Ag–W compositions are summarized in Table 2.16.

- Plot the resistivity and density of the Ag–W alloy against the W content (wt. %)
- Show that the density of the mixture, d , is given by

$$d^{-1} = w_{\alpha} d_{\alpha}^{-1} + w_{\beta} d_{\beta}^{-1}$$

where w_{α} is the weight fraction of phase α , w_{β} is the weight fraction of phase β , d_{α} is the density of phase α , and d_{β} is the density of phase β . Calculate d and plot it in *a* above.

- Show that the resistivity mixture rule is

$$\rho = \rho_{\alpha} \frac{dw_{\alpha}}{d_{\alpha}} + \rho_{\beta} \frac{dw_{\beta}}{d_{\beta}}$$

where ρ is the resistivity of the alloy (mixture), d is the density of the alloy (mixture), and subscripts α and β refer to phases α and β , respectively.

- d. Calculate the density d and the resistivity ρ of the mixture for various values of W content (in wt. %) and plot the calculated values in the same graph as the experimental values. Try both the resistivity and conductivity mixture rules. What is your conclusion?

Table 2.16 Dependence of resistivity in Ag–W alloy on composition as a function of wt.% W

	W(wt.%)												
	0	10	15	20	30	40	65	70	75	80	85	90	100
ρ (n Ω m)	16.2	18.6	19.7	20.9	22.7	27.6	35.5	38.3	40	46	47.9	53.9	55.6
d (g cm ⁻³)	10.5	10.75	10.95	11.3	12	12.35	14.485	15.02	15.325	16.18	16.6	17.25	19.1

NOTE: ρ = resistivity and d = density.

Solution

- a. The plot of density versus W weight percentage data in Table 2Q21-1, from Table 2.16, is shown in Figure 2Q21-1

Table 2Q20-1 Resistivity of Ag-W alloys

wt.% W	Ag-W Alloy	
	Resistivity	Density
	[n Ω m]	[g cm ⁻³]
0	16.2	10.5
10	18.6	10.75
15	19.7	10.95
20	20.9	11.3
30	22.7	12
40	27.6	12.35
65	35.5	14.485
70	38.3	15.02
75	40	15.325
80	46	16.18
85	47.9	16.6
90	53.9	17.25
100	55.6	19.1

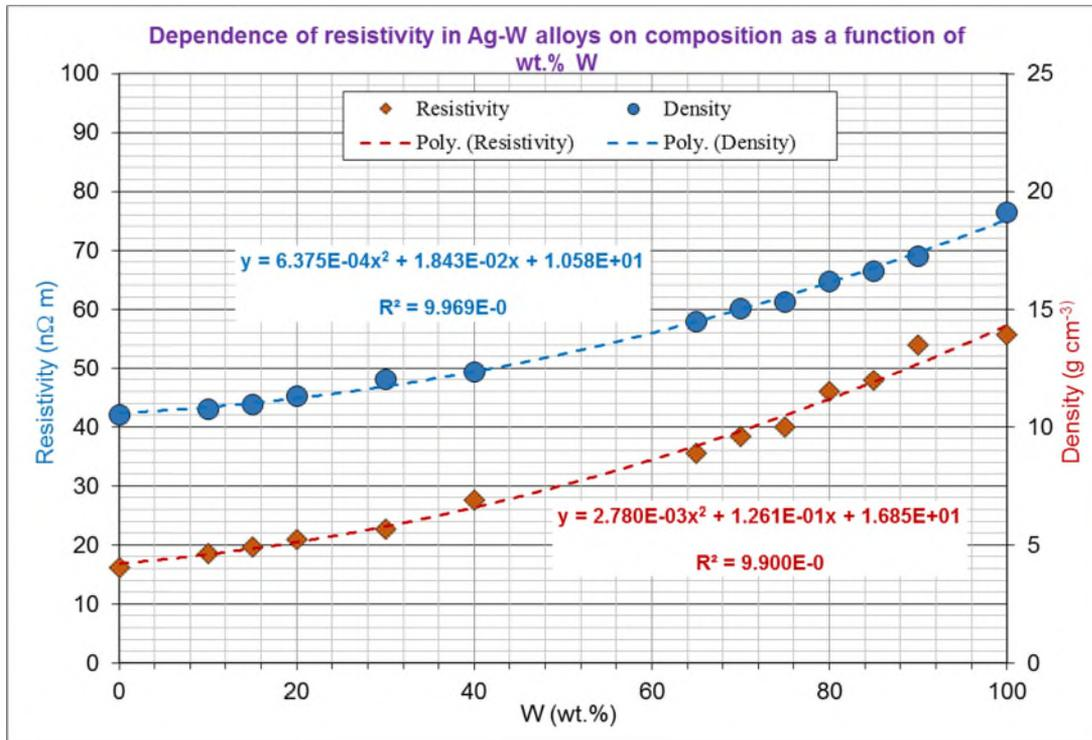

Figure 2Q21-1: Experimental resistivity and density vs. composition of W in wt%. A simple second order polynomial provides a reasonable fit.

b. The given mixture consists of two phases α , and β . Assume that the total mass of the alloy is M_{mixture} . If w_α and w_β are the weight fractions of α , and β phases, then their respective masses in the mixture are

$$M_\alpha = w_\alpha M_{\text{mixture}}$$

$$M_\beta = w_\beta M_{\text{mixture}}$$

The densities of the phases α , and β , are d_α and d_β , therefore the volume occupied by these phases can be calculated using the definition of density. *i.e.* density = mass / volume, we have

$$V_\alpha = \frac{\text{mass of } \alpha}{\text{density of } \alpha} = \frac{M_\alpha}{d_\alpha} = \frac{w_\alpha M_{\text{mixture}}}{d_\alpha}$$

$$V_\beta = \frac{\text{mass of } \beta}{\text{density of } \beta} = \frac{M_\beta}{d_\beta} = \frac{w_\beta M_{\text{mixture}}}{d_\beta}$$

The total volume of the alloy mixture is

$$V_{\text{mixture}} = V_\alpha + V_\beta = \frac{w_\alpha M_{\text{mixture}}}{d_\alpha} + \frac{w_\beta M_{\text{mixture}}}{d_\beta}$$

The density of the mixture is therefore,

$$d = \frac{M_{\text{mixture}}}{V_{\text{mixture}}} = \frac{M_{\text{mixture}}}{\frac{w_\alpha M_{\text{mixture}}}{d_\alpha} + \frac{w_\beta M_{\text{mixture}}}{d_\beta}} = \frac{M_{\text{mixture}}}{M_{\text{mixture}} \left(\frac{w_\alpha}{d_\alpha} + \frac{w_\beta}{d_\beta} \right)} = \frac{1}{\left(\frac{w_\alpha}{d_\alpha} + \frac{w_\beta}{d_\beta} \right)}$$

or
$$\frac{1}{d} = \frac{w_\alpha}{d_\alpha} + \frac{w_\beta}{d_\beta} \quad (1)$$

Figure 2Q21-2 shows the experimental and calculated density vs. W (wt. %) points and it is clear that the effective density equation in (1) is quite good in predicting the density over the whole alloy composition.

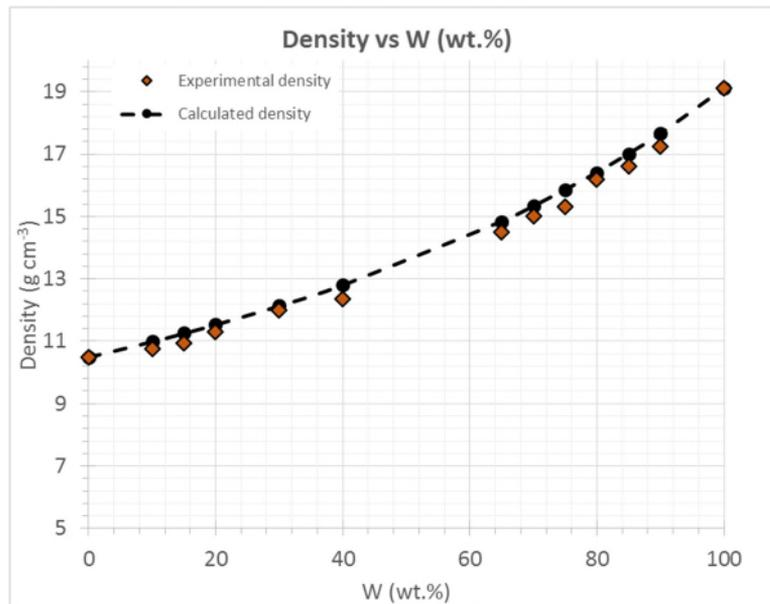

Figure 2Q21-2 Experimental and calculated density vs. W (wt. %)

c. The resistivity-mixture rule or the series rule of mixtures is defined in Equation 2.30 as

$$\rho_{\text{eff}} = \chi_\alpha \rho_\alpha + \chi_\beta \rho_\beta$$

where χ_α and χ_β are the volume fractions of phase α and β respectively. (For detailed derivation of this rule please see Example 2.14.) Volume fractions of the two phases are,

$$\chi_\alpha = \frac{V_\alpha}{V_{\text{mixture}}} \quad \text{and} \quad \chi_\beta = \frac{V_\beta}{V_{\text{mixture}}}$$

From part a of this problem, the volume of the phases α and β in the mixture are

$$V_\alpha = \frac{w_\alpha M_{\text{mixture}}}{d_\alpha} \quad \text{and} \quad V_\beta = \frac{w_\beta M_{\text{mixture}}}{d_\beta}$$

and the volume of the mixture is $V = \frac{M_{\text{mixture}}}{d}$, therefore the volume fraction of the two contents is

$$\chi_\alpha = \frac{V_\alpha}{V} = \frac{\frac{w_\alpha M_{\text{mixture}}}{d_\alpha}}{\frac{M_{\text{mixture}}}{d}} = \frac{w_\alpha d}{d_\alpha} \quad \text{and} \quad \chi_\beta = \frac{V_\beta}{V} = \frac{\frac{w_\beta M_{\text{mixture}}}{d_\beta}}{\frac{M_{\text{mixture}}}{d}} = \frac{w_\beta d}{d_\beta}$$

In summary, the volume fractions are

$$\chi_{\alpha} = \frac{w_{\alpha}d}{d_{\alpha}} \quad \text{and} \quad \chi_{\beta} = \frac{w_{\beta}d}{d_{\beta}} \quad (2)$$

Substituting the volume fraction χ_{α} and χ_{β} , the resistivity mixture rule is

$$\rho_{\text{eff}} = \frac{w_{\alpha}d}{d_{\alpha}} \rho_{\alpha} + \frac{w_{\beta}d}{d_{\beta}} \rho_{\beta} \quad (3)$$

d. We calculate the density and the resistivity using the relations proved in parts **b** and **c**. As an example, for 30% W wt. content, the density and resistivity are,

$$d^{-1} = w_{\text{Ag}}d_{\text{Ag}}^{-1} + w_{\text{W}}d_{\text{W}}^{-1} = \frac{(1-0.3)}{10.5 \text{ g cm}^{-3}} + \frac{(0.3)}{19.1 \text{ g cm}^{-3}}$$

$$d = 12.14 \text{ g cm}^{-3}.$$

The measured value in Table 2.16 is 12.0 so the calculated value is very close (within 1%).

Using the resistivity-mixture rule, the resistivity of the alloy ρ_{eff} is

$$\rho_{\text{eff}} = \rho_{\text{Ag}} \frac{d \cdot w_{\text{Ag}}}{d_{\text{Ag}}} + \rho_{\text{W}} \frac{d \cdot w_{\text{W}}}{d_{\text{W}}}$$

$$\therefore \rho_{\text{eff}} = (16.2 \text{ n}\Omega \text{ m}) \frac{(12.0 \text{ g cm}^{-3})(1-0.3)}{(10.5 \text{ g cm}^{-3})} + (55.6 \text{ n}\Omega \text{ m}) \frac{(12.0 \text{ g cm}^{-3})(0.3)}{(19.1 \text{ g cm}^{-3})}$$

$$\therefore \rho_{\text{eff}} = 23.44 \text{ n}\Omega \text{ m}$$

The experimental resistivity as given in the table is 22.7 nΩ m; difference is only 3.3%. Similarly, the densities and resistivities for the given W contents are calculated and listed in the Table 2Q21-2.

Using the conductivity-mixture rule, the resistivity of the alloy ρ_{eff} is

$$\left(\frac{1}{\rho_{\text{eff}}} \right) = \left(\frac{1}{\rho_{\text{Ag}}} \right) \frac{d \cdot w_{\text{Ag}}}{d_{\text{Ag}}} + \left(\frac{1}{\rho_{\text{W}}} \right) \frac{d \cdot w_{\text{W}}}{d_{\text{W}}}$$

substituting in the values for the RHS

$$\therefore \frac{1}{\rho_{\text{eff}}} = (16.2 \text{ n}\Omega \text{ m})^{-1} \frac{(12.0 \text{ g cm}^{-3})(1-0.3)}{(10.5 \text{ g cm}^{-3})} + (55.6 \text{ n}\Omega \text{ m})^{-1} \frac{(12.0 \text{ g cm}^{-3})(0.3)}{(19.1 \text{ g cm}^{-3})}$$

$$\therefore \rho_{\text{eff}} = 18.95 \text{ n}\Omega \text{ m}$$

The experimental resistivity is given in the table as 22.7 nΩ m; the difference is significant, 16%, especially with respect to the prediction of the series resistivity rule. *Clearly the conductivity mixture rule fails.*

Similarly, the resistivities for the given W contents are all calculated and listed in the Table 2Q21-2. Figure 2Q21-3 shows the plot of experimental resistivity vs. W content and the resistivities from resistivity and conductivity mixture rules in Equations 2.30 and 2.31 respectively.

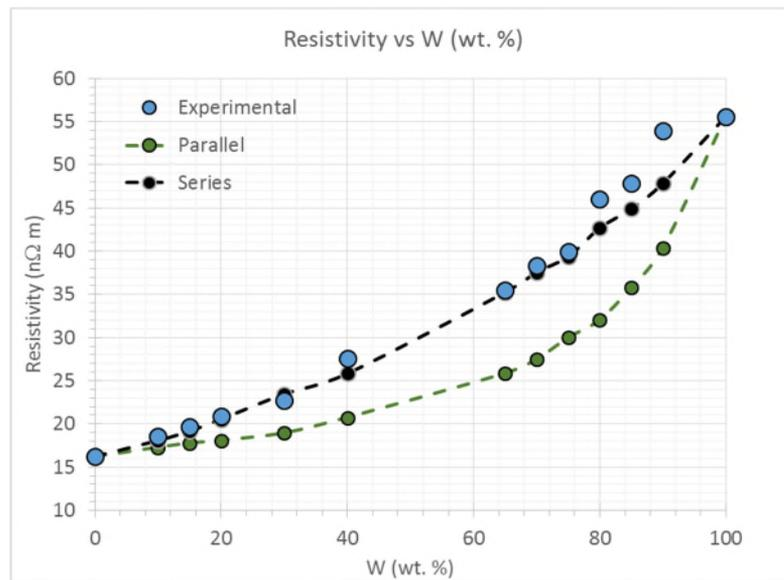

Figure 2Q21-3 Experimental resistivity and resistivities from resistivity and conductivity mixture rules vs. W (wt. %)

Table 2Q21-2: Resistivity of Ag–W alloy as a function of wt.% W calculated using series mixture and parallel mixture rules.

W wt. %	Volume Fraction	Experimental density (g cm ⁻³)	Calculated density (g cm ⁻³)	Experimental resistivity (nΩ m)	Resistivity mixture rule (nΩ m)	Conductivity mixture rule (nΩ m)
0	0.000	10.5	10.50	16.2	16.20	16.20
10	0.056	10.75	11.00	18.6	18.06	18.6
15	0.086	10.95	11.26	19.7	19.14	19.7
20	0.118	11.3	11.54	20.9	20.53	20.9
30	0.188	12.0	12.14	22.7	23.44	22.7
40	0.259	12.35	12.81	27.6	25.81	27.6
65	0.493	14.485	14.84	35.5	35.23	35.5
70	0.550	15.02	15.33	38.3	37.56	38.3
75	0.602	15.325	15.85	40	39.37	40
80	0.678	16.18	16.41	46	42.67	46
85	0.739	16.6	17.01	47.9	44.92	47.9
90	0.813	17.25	17.65	53.9	47.85	53.9
100	1.000	19.1	19.10	55.6	55.60	55.6

Major assumption: Ag–W is a two phase alloy, made up of α (Ag-rich) and β (W-rich) phases. We assumed that we can simply use the properties of Ag for the α and the properties of W for the β phase.

Comment: The data were collected from a variety of sources (various handbooks and papers) and combined into a single table. The data are not simply from a single source. Hence the experimental values show some scatter.

Given the scatter, the resistivity mixture model is in very good agreement with the experimental data. The conductivity mixture rule fails badly in this case.

2.22 Strain gauges Consider a strain gauge that consists of a nichrome wire of resistivity $1100 \text{ n}\Omega \text{ m}$, TCR (α) = 0.0004 K^{-1} , a total length of 25 cm , and a diameter of $50 \text{ }\mu\text{m}$. What is δR for a strain of 10^{-3} ? For nichrome, $\nu \approx 0.3$. What is δR if there is a temperature variation of $1 \text{ }^\circ\text{C}$, given that the linear thermal expansion coefficient is 15 ppm K^{-1} ?

Solution

2Q22 Strain gauge

Properties of NiCr wire are

$\rho = 1100(1 \times 10^{-9}) \text{ }\Omega \text{ m}$

$\alpha = 0.0004 \text{ 1/K}$

Poisson 's ratio ν is

$\nu = 0.3$

Wire dimensions

$L = 0.35 \text{ m}$ $D = 2 \times 10^{-5} \text{ m}$

The given strain is

$\varepsilon = 0.001$

NiCr wire has a resistance R ,

$R = \frac{\rho L}{\pi \left(\frac{D}{2}\right)^2}$

$R = 1225.5 \text{ }\Omega$ Calculate

$1,225.5 \text{ }\Omega$

Change in resistance δR due to strain ε is

$\delta R = (1 + 2\nu)R\varepsilon$

$\delta R = 1.9608 \text{ }\Omega$ Calculate

$1.96 \text{ }\Omega$

TEMPERATURE CHANGES =====

Temperature change is δT

$\delta T = 1 \text{ C or K}$

Thermal expansion coefficient is λ

$\lambda = 1.5 \times 10^{-5} \text{ 1/C or 1/K}$

The change in the temperature δT gives δR

$\delta R = R(\alpha - \lambda)\delta T$

$\delta R = 0.47181 \text{ }\Omega$ Calculate

$0.472 \text{ }\Omega$

Clearly we can easily measure the strain through δR , which is roughly $2 \text{ }\Omega$; although a temperature fluctuation can significantly affect the measurement. Indeed, we need to compensate for the temperature fluctuation effects, otherwise the changes in δR will not reflect the changes in the strain. See Question 2.23

Comment: $\lambda = 14 \text{ ppm/K}$ is typical of nichrome wires

2.23 Strain measurements How would you use strain gauges in a Wheatstone bridge circuit to measure strains and reduce the effects of temperature variations? What would be the advantages and disadvantages of such a bridge circuit?

Solution

Figure 2Q23-1a shows a Wheatstone bridge. In Figure 2Q23-1b, R_4 is the strain gauge, represented as R_s . The voltage between the terminals b and a is given by

$$\delta V = V_b - V_a = V \left(\frac{R_1}{R_1 + R_2} \right) - V \left(\frac{R_3}{R_3 + R_4} \right)$$

so that the normalized voltage v between b and a is

$$v = \frac{V_b - V_a}{V} = \left(\frac{R_1}{R_1 + R_2} \right) - \left(\frac{R_4}{R_3 + R_4} \right)$$

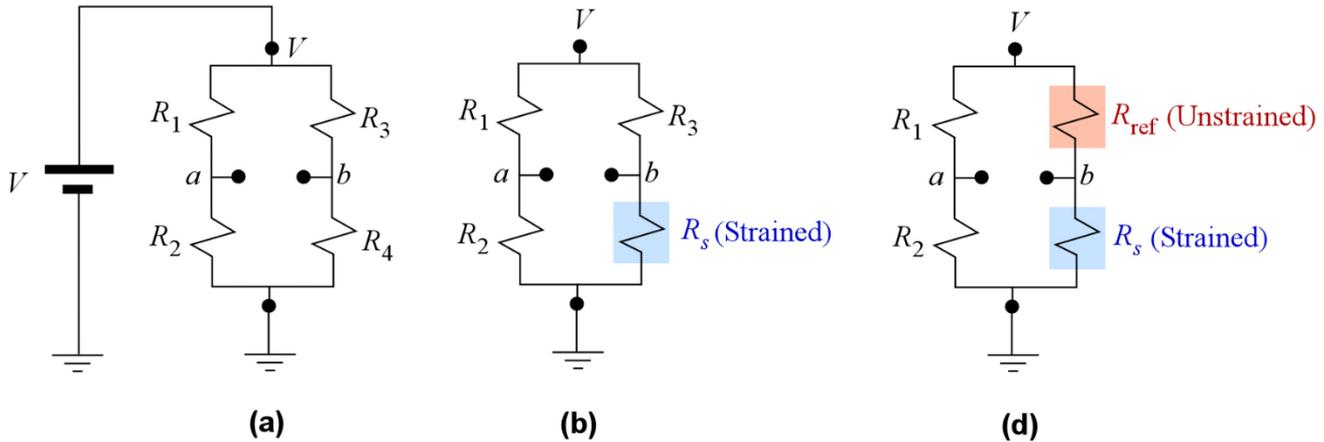

Figure 2Q23-1 Wheatstone bridge configurations for measuring strain.

I. Strain measurement without temperature compensation, and R_4 as the strain gauge R_s

Take $R_4 = R_s$, the strain gauge. A small change in R_s gives a change in v ,

$$v = \frac{V_b - V_a}{V} = \left(\frac{R_1}{R_1 + R_2} \right) - \left(\frac{R_s}{R_3 + R_s} \right) \quad (1)$$

$$\therefore \frac{\delta v}{\delta R_s} = - \left(\frac{1}{R_3 + R_s} \right) + \frac{R_s}{(R_3 + R_s)^2} = - \frac{R_3}{(R_3 + R_s)^2}$$

$$\therefore \frac{\delta v}{\delta R_s} = - \frac{R_3}{(R_3 + R_s)^2} \quad (2)$$

The fractional change in the voltage δv per unit fractional change in R_s is the sensitivity S , that is,

$$S = \frac{dv}{\left(\frac{dR_s}{R_s} \right)} = - \frac{R_3 R_s}{(R_3 + R_s)^2}$$

Representing the ratio $R_s/R_3 = x$, we have

$$S = \frac{dv}{\left(\frac{dR_s}{R_s} \right)} = - \frac{R_3^2 x}{(R_3 + R_3 x)^2} = - \frac{R_3^2 x}{(R_3 + R_3 x)^2}$$

$$\therefore S = \frac{dv}{\left(\frac{dR_s}{R_s} \right)} = - \frac{R_3^2 x}{(R_3 + R_3 x)^2} = - \frac{x}{(1+x)^2} \quad (3)$$

This quantity represents how the sensitivity S of the bridge depends on $R_s/R_3 = x$ as shown in Figure 2Q23-2. Clearly, S has a maximum magnitude at $x = 1$, that is, when $R_s = R_4 = R_3$ and it is $S = -0.25$

$$\therefore S_{\max} = -\frac{1}{4}$$

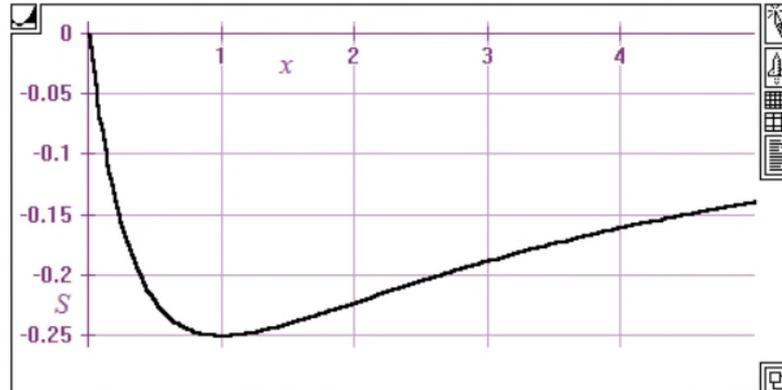

Figure 2Q23-2 Sensitivity vs. $x = R_3/R_s$

Consider a strain gauge with a gauge factor (GF) of 1.6 (see Example 2.13), $V = 10$ V and $R_s = 1000$ Ω . What is the signal for a strain of 0.1%?

$$\frac{\delta R_s}{R_s} = \text{GF}\varepsilon = 1.6(1 \times 10^{-3}) = 1.6 \times 10^{-3}$$

The voltage change is

$$\left(\frac{\delta V}{V}\right) = -(1/4)\left(\frac{\delta R_s}{R_s}\right) = -(0.25)(1.6 \times 10^{-3}) = 0.4 \times 10^{-3}$$

or $\delta V = (10 \text{ V})(0.4 \times 10^{-3}) = 0.004$ V or 4 mV, which is measurable

Note that the responsivity (δV) can be increased by using a higher V across the bridge. 20 V would give a voltage change of 8 mV.

II. Temperature compensation

In this case, we need to compensate for the change in R_4 with temperature. If an exactly identical strain gauge is used for R_3 (which is called a reference gauge R_{ref}) but only R_4 is subject to the strain, and both are subject to the same temperature change, then δV will not be affected by a temperature variation. The circuit is shown in Figure 2Q23-1c. Consider

$$v = \left(\frac{R_2}{R_1 + R_2}\right) - \left(\frac{R_4}{R_3 + R_4}\right)$$

Assume $R_1 = R_2$, $R_3 = R_4$ (for maximum bridge sensitivity). For a temperature change δT , $\delta R_1 = \delta R_2$ and $\delta R_3 = \delta R_4$ so that we always have $v = 0$.

However, the strain only affects R_4 and not R_3 . The derivation in Part I is valid and

$$S = \frac{\delta V/V}{\delta R_s/R_s} = -\frac{1}{4}$$

Advantages

1. In a Wheatstone bridge sensing circuit, one is measuring changes about zero volts across the bridge between a and b in Figure 2Q23-1b.

2. Changes in the temperature can be compensated with a "reference" strain gauge for R_3 and the sensing gauge for R_4 .
3. The responsivity can be increased by using a higher applied voltage without any dc shift in the voltage between a and b .
4. We can use identical strain gauges for $R_1 = R_2 = R_3 = R_4$ and allow only R_1 and R_3 be subjected to the same strain. This would provide twice the sensitivity

2.24 Strain gauges Suppose you wish to construct a strain gauge from constantan, which is 55%Cu-45%Ni alloy. Constantan has a resistivity of $500 \text{ n}\Omega \text{ m}$, TCR (α) of $8 \times 10^{-6} \text{ K}^{-1}$, linear thermal expansion coefficient (λ) of $14.9 \times 10^{-6} \text{ K}^{-1}$ and a Poisson ratio ν of 0.3. Suppose that the strain gauge uses 50 cm of wire and the diameter is $5 \text{ }\mu\text{m}$. What is δR for a strain of 10^{-3} ? What is δR if there is a temperature variation of $1 \text{ }^\circ\text{C}$?

Solution

2Q24 Strain gauge

Properties of constantan (55Cu-45Ni) wire are given as

$\rho = 500(1 \times 10^{-9}) \text{ }\Omega \text{ m}$

$\alpha = 8 \times 10^{-6} \text{ 1/K}$

Poisson's ratio ν is

$\nu = 0.3$

Wire dimensions

$L = 0.5 \text{ m}$ $D = 5 \times 10^{-6} \text{ m}$

The given strain is

$\varepsilon = 0.001$

NiCr wire has a resistance R ,

$R = \frac{\rho L}{\pi \left(\frac{D}{2}\right)^2}$

$R = 12732 \text{ }\Omega$ Calculate

12.73 k Ω

Change in resistance δR due to strain ε is

$\delta R = (1 + 2\nu)R\varepsilon$

$\delta R = 20.372 \text{ }\Omega$ Calculate

20.4 Ω

TEMPERATURE CHANGES =====

Temperature change is δT

$\delta T = 1 \text{ }^\circ\text{C or K}$

Thermal expansion coefficient is λ

$\lambda = 1.49 \times 10^{-5} \text{ 1/C or 1/K}$

The change in the temperature δT gives δR

$\delta R = R(\alpha - \lambda)\delta T$

$\delta R = -0.087854 \text{ }\Omega$ Calculate

The resistance decreases by a small amount

It is clear that the change δR in resistance due to a small temperature change of $1 \text{ }^\circ\text{C}$ is a fraction of the change in R due to the strain. This is a distinct advantage of constantans. Their thermal coefficient of resistivity (TCR) is generally very small.

2.25 Strain gauges Consider the derivation of Equation 2.26 for metal strain gauges. Is the equation the same if the cross section is a rectangle with dimensions $a \times b$ instead of a circular area of diameter D ? Does this equation depend on the shape of the cross section? What would be the advantage of using a gauge made from thin film strips on a carrier substrate that could be bonded to the structure under test? How important is the substrate in strain measurements?

Solution

Consider a metal strip with a cross sectional area ab

$$R = \frac{\rho L}{ab} \quad (1)$$

The applied load changes L , a and b by δL , δa and δb , which change R by δR . The total derivative of a function R of three variables L , a and b can be found by taking partial differentials

$$\delta R = \left(\frac{\partial R}{\partial L} \right) \delta L + \left(\frac{\partial R}{\partial a} \right) \delta a + \left(\frac{\partial R}{\partial b} \right) \delta b \quad (2)$$

We can substitute from Equation (1) into (2) to find,

$$\delta R = \frac{\rho}{ab} \delta L - \frac{\rho L}{a^2 b} \delta a + \frac{\rho L}{ab^2} \delta b \quad (3)$$

$$\therefore \frac{\delta R}{R} = \frac{\frac{\rho}{ab} \delta L - \frac{\rho L}{a^2 b} \delta a + \frac{\rho L}{ab^2} \delta b}{\frac{\rho L}{ab}}$$

$$\therefore \frac{\delta R}{R} = \frac{\delta L}{L} - \frac{\delta a}{a} + \frac{\delta b}{b} \quad (4)$$

The longitudinal and transverse strains, ε_l and ε_t , are defined as follows

$$\frac{\delta L}{L} = \varepsilon_l \quad \text{and} \quad \frac{\delta a}{a} = \frac{\delta a}{b} = \varepsilon_t = -\nu \varepsilon_l \quad (5)$$

where ν is the Poisson ratio. Thus

$$\frac{\delta R}{R} = \varepsilon_l + \nu \varepsilon_l + \nu \varepsilon_l$$

$$\therefore \frac{\delta R}{R} = \varepsilon(1 + 2\nu) \quad (6)$$

which is the same as that for the circular cross sectional wire in Equation 2.26. Clearly, the result is independent of the exact cross sectional area shape.

Thin film strips are much easier to bond directly on to an insulating substrate (a carrier structure that will hold – carry – the metal strips) with good contact. Usually substrates are polymers such as polyimide (Kapton). Good contact between the metal strips and the substrate is essential because we need the strain to be transmitted to the metal strips. The substrate has to be such that it can be bonded to the structure easily and be able to transmit the strain to the metal gauge. Most substrates have to be flexible as well so that they be bonded onto various surface. The adhesive between the substrate and the

structure is also very important because the bond has to transfer the strain from the structure to the substrate. Some strain gauges have the metal wires embedded in a polymer sheet.

2.26 Thermal coefficients of expansion and resistivity

- a. Consider a thin metal wire of length L and diameter D . Its resistance is $R = \rho L/A$, where $A = \pi D^2/4$. By considering the temperature dependence of L , A , and ρ individually, show that

$$\frac{1}{R} \frac{dR}{dT} = \alpha_o - \lambda_o$$

where α_o is the temperature coefficient of resistivity (TCR), and λ_o is the temperature coefficient of linear expansion (thermal expansion coefficient or expansivity), that is,

$$\lambda_o = L_o^{-1} \left(\frac{dL}{dT} \right)_{T=T_o} \quad \text{or} \quad \lambda_o = D_o^{-1} \left(\frac{dD}{dT} \right)_{T=T_o}$$

Note: Consider differentiating $R = \rho L/[(\pi D^2)/4]$ with respect to T with each parameter, ρ , L , and D , having a temperature dependence.

Given that typically, for most pure metals, $\alpha_o \approx 1/273 \text{ K}^{-1}$ and $\lambda_o \approx 2 \times 10^{-5} \text{ K}^{-1}$, confirm that the temperature dependence of ρ controls R , rather than the temperature dependence of the geometry. Is it necessary to modify the given equation for a wire with a noncircular cross section?

- b. Is it possible to design a resistor from a suitable alloy such that its temperature dependence is almost nil? Consider the TCR of an alloy of two metals A and B , for which $\alpha_{AB} \approx \alpha_A \rho_A / \rho_{AB}$.

Solution

- a. Consider the resistance R of the wire,

$$R = \frac{\rho L}{\pi \left(\frac{D}{2} \right)^2} \tag{1}$$

Consider a change δR in R due to a change δT in the temperature. We can differentiate R with respect to T by considering that ρ , L , and D depend on T ,

$$\frac{dR}{dT} = \frac{d}{dT} \left(\frac{\rho L}{\frac{\pi}{4} D^2} \right) = \left(\frac{L}{\frac{\pi}{4} D^2} \right) \frac{d\rho}{dT} + \left(\frac{\rho}{\frac{\pi}{4} D^2} \right) \frac{dL}{dT} - 2 \left(\frac{\rho L}{\frac{\pi}{4} D^3} \right) \frac{dD}{dT}$$

divide by R , $\left(\frac{1}{R} \right) \frac{dR}{dT} = \left(\frac{1}{\rho} \right) \frac{d\rho}{dT} + \left(\frac{1}{L} \right) \frac{dL}{dT} - 2 \left(\frac{1}{D} \right) \frac{dD}{dT}$ (2)

At $T = T_o$ we have,

$$\left(\frac{1}{R}\right)\frac{dR}{dT} = \left(\frac{1}{\rho_o}\right)\frac{d\rho}{dT} + \left(\frac{1}{L_o}\right)\frac{dL}{dT} - 2\left(\frac{1}{D_o}\right)\frac{dD}{dT} \quad (3)$$

where the derivatives are at $T = T_o$. Recall that the temperature coefficient of resistivity, TCR (α_o), and the linear expansion coefficient λ_o are defined as follows,

$$\alpha_o = \left(\frac{1}{\rho_o}\right)\frac{d\rho}{dT} \quad \text{and} \quad \lambda_o = \left(\frac{1}{L_o}\right)\frac{dL}{dT} = \left(\frac{1}{D_o}\right)\frac{dD}{dT} \quad (4)$$

which reduces Eqn. (3) to

$$\left(\frac{1}{R}\right)\frac{dR}{dT} = \alpha_o - \lambda_o \quad (5)$$

Typically $\lambda_o \approx 2 \times 10^{-5} \text{ K}^{-1}$, and for pure metals $\alpha_o \approx 1/273 \text{ K}^{-1}$ or $3.6 \times 10^{-3} \text{ K}^{-1}$. Thus,

$$\left(\frac{1}{R}\right)\frac{dR}{dT} = 3.6 \times 10^{-3} \text{ K}^{-1} - 2 \times 10^{-5} \text{ K}^{-1} \approx 3.6 \times 10^{-3} \text{ K}^{-1} \approx \alpha_o$$

Since α_o is much larger than λ_o , it dominates the change in R .

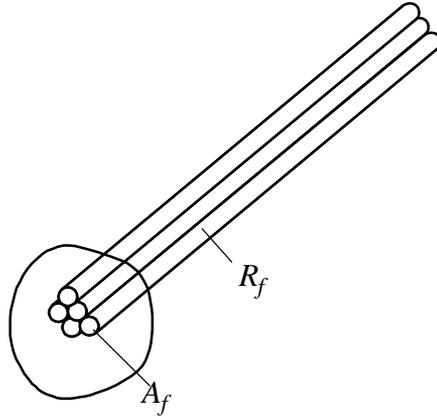

Figure 2Q22-1: Wire with non-circular cross section.

There is no need to modify Eqn. (5) for a non-circular cross sectional area. You can derive the same expression for a rectangular or an elliptic cross section, or, indeed, any arbitrary cross section. One can consider the wire to be made up of N thin fibers each of *circular* cross section A_f . Imagine holding a bunch of these in your hand and then sliding them into any cross section you like as in the Figure 2Q22-1. In all cases $A = \Sigma A_f$. However, since the fibers are in parallel, the total resistance is given by $R^{-1} = \Sigma R_f^{-1} = N R_f^{-1}$. Thus $R = R_f / N$. For each fiber, $\delta R_f = R_f(\alpha_o - \lambda_o)\delta T$ as we have derived above. Then,

$$\delta R = (\delta R_f) / N = [R_f(\alpha_o - \lambda_o)\delta T] / N = R(\alpha_o - \lambda_o)\delta T$$

[There are a few assumptions such as the resistivity is homogeneous and the cross section does not change along the wire!]

b. For pure metals, $\alpha_o \gg \lambda_o$. Alloying metal A with metal B reduces the TCR (temperature coefficient of resistivity) α_A of metal A to $\alpha_{AB} = \alpha_A(\rho_A/\rho_{AB})$. The $\alpha_o - \lambda_o$ can be brought to zero by using a suitable composition alloy for which $\alpha_o = \lambda_o$. Since α_o strictly depends (however slightly) on T , the condition

$\alpha_o - \lambda_o$ can only be exactly true at one temperature or approximately true in a small region around that temperature. In practice this temperature range may be sufficient to cover a typical application range in which, for most practical purposes, $\alpha_o - \lambda_o$ is negligible.

2.27 Thermal conduction Consider brass alloys with an X atomic fraction of Zn. These alloys form a solid solution up to 30 at. %, and we can use the combined Matthiessen-Nordheim rule in Equation 2.21 to calculate the resistivity of the alloy. Take $C = 300 \text{ n}\Omega \text{ m}$ and $\rho_o = \rho_{\text{Cu}} = 17 \text{ n}\Omega \text{ m}$.

- a. An 80 at. % Cu–20 at. % Zn brass disk of 40 mm diameter and 5 mm thickness is used to conduct heat from a heat source to a heat sink.
- (1) Calculate the thermal resistance of the brass disk.
 - (2) If the disk is conducting heat at a rate of 100 W, calculate the temperature drop along the disk.
- b. What should be the composition of brass if the temperature drop across the disk is to be halved?

Solution

a.

(1) Assume $T = 20 \text{ }^\circ\text{C} = 293 \text{ K}$. Apply Equation 2.22 to find the resistivity of the brass in the disk with $\rho_{\text{Cu}} = 17.1 \text{ n}\Omega \text{ m}$ and $X_{\text{Zn}} = 0.20$:

$$\rho_{\text{brass}} = \rho_{\text{Cu}} + C_{\text{Zn-in-Cu}} X_{\text{Zn}} (1 - X_{\text{Zn}})$$

$$\text{i.e.} \quad \rho_{\text{brass}} = 17.1 \text{ n}\Omega \text{ m} + (300 \text{ n}\Omega \text{ m})(0.20)(1 - 0.20)$$

$$\therefore \quad \rho_{\text{brass}} = 65.1 \text{ n}\Omega \text{ m}$$

We know that the thermal conductivity is given by $\kappa/\sigma_{\text{brass}} = C_{\text{FWL}}T$ where σ_{brass} is the conductivity of the disk, C_{FWL} is the Lorenz number and T is the temperature. This equation can also be written as $\kappa\rho_{\text{brass}} = C_{\text{FWL}}T$ so that $\kappa = C_{\text{FWL}}T/\rho$. Applying this equation,

$$\kappa(20 \text{ }^\circ\text{C}) = (2.44 \times 10^{-8} \text{ W } \Omega \text{ K}^{-2})(293 \text{ K}) / (6.51 \times 10^{-8} \text{ } \Omega \text{ m})$$

$$\therefore \quad \kappa(20 \text{ }^\circ\text{C}) = 109.8 \text{ W K}^{-1} \text{ m}^{-1}$$

The thermal resistance is $\theta = L/(\kappa A)$, where L is the thickness of the disk and A is the cross-sectional area of the disk.

$$\theta = L/(\kappa A) = (5 \times 10^{-3} \text{ m}) / [(109.8 \text{ W K}^{-1} \text{ m}^{-1})(\pi)(2 \times 10^{-2} \text{ m})^2] = \mathbf{0.0362 \text{ K W}^{-1}}$$

(2) From $dQ/dt = A\kappa\Delta T/\Delta x = \Delta T/\theta$ (Δx can be taken to be the same as L), and $dQ/dt = P$ (power conducted), we can substitute to obtain:

$$\Delta T = P\theta = (100 \text{ W})(3.62 \times 10^{-2} \text{ K W}^{-1}) = \mathbf{3.62 \text{ K or } 3.62 \text{ }^\circ\text{C}}$$

Note: Change in temperature is the same in either Kelvins or degrees Celsius, *i.e.* $\Delta T = T_1 - T_2 = (T_1 + 273) - (T_2 + 273)$.

b. Since $\Delta T = P\theta$, to get half ΔT , we need half θ or double κ or double σ or half ρ . We thus need $1/2\rho_{\text{brass}}$ or $1/2(65.1 \text{ n}\Omega \text{ m})$ which can be attained if the brass composition is X_{new} so that

$$\rho_{\text{new}} = \rho_{\text{Cu}} + C_{\text{Zn in Cu}} X_{\text{new}}(1 - X_{\text{new}})$$

$$\text{i.e.} \quad \frac{1}{2}(65.1 \text{ n}\Omega \text{ m}) = 17 \text{ n}\Omega \text{ m} + (300 \text{ n}\Omega \text{ m})X_{\text{new}}(1 - X_{\text{new}})$$

Solving this quadratic equation we get $X_{\text{new}} = 0.0545$, or 5.5% Zn. Thus we need **94.5% Cu-5.5% Zn** brass.

2.28 Thermal resistance Consider a thin insulating disc made of mica to electrically insulate a semiconductor device from a conducting heat sink. Mica has $\kappa = 0.75 \text{ W m}^{-1} \text{ K}^{-1}$. The disk thickness is 0.1 mm, and the diameter is 10 mm. What is the thermal resistance of the disk? What is the temperature drop across the disk if the heat current through it is 5 W?

Solution

The thermal resistance of the mica disk can be calculated directly from Equation 2.46. If L is the thickness of the disk and D is the diameter

$$\theta = \frac{L}{\kappa A} = \frac{L}{\kappa \pi (D/2)^2} = \frac{(0.1 \times 10^{-3} \text{ m})}{\pi (0.75 \text{ W m}^{-1} \text{ K}^{-1}) \left(\frac{1 \times 10^{-2} \text{ m}}{2} \right)^2} = \mathbf{1.70 \text{ K W}^{-1}}$$

The temperature drop across the disk according to Equation 2.43 is

$$\Delta T = Q'\theta = (5 \text{ W})(1.70 \text{ K W}^{-1}) = \mathbf{8.5 \text{ }^\circ\text{C}}$$

***2.29 Thermal resistance** Consider a coaxial cable operating under steady state conditions when the current flow through the inner conductor generates Joule heat at a rate $P = I^2 R$. The heat generated per second by the core conductor flows through the dielectric; $Q' = I^2 R$. The inner conductor reaches a temperature T_i whereas the outer conductor is at T_o . Show that the thermal resistance θ of the hollow cylindrical insulation for heat flow in the radial direction is

$$\theta = \frac{(T_i - T_o)}{Q'} = \frac{\ln\left(\frac{b}{a}\right)}{2\pi\kappa L} \quad \text{Thermal resistance of hollow cylinder} \quad [2.87]$$

where a is the inside (core conductor) radius, b is the outside radius (outer conductor), κ is the thermal conductivity of the insulation, and L is the cable length. Consider a coaxial cable that has a copper core conductor and polyethylene (PE) dielectric with the following properties: Core conductor resistivity $\rho = 19 \text{ n}\Omega \text{ m}$, core radius, $a = 4 \text{ mm}$, dielectric thickness, $b - a = 3.5 \text{ mm}$, dielectric thermal conductivity $\kappa = 0.3 \text{ W m}^{-1} \text{ K}^{-1}$. The outside temperature T_o is $25 \text{ }^\circ\text{C}$. The cable is carrying a current of 500 A. What is the temperature of the inner conductor?

Solution

Consider a thin cylindrical shell of thickness dr as shown in Figure 2Q29-1. The problem with the thermal equivalent circuit is shown in Figure 2Q29-2. The temperature difference across dr is dT . The surface area of this shell is $2\pi rL$. Thus, from Fourier's law,

$$Q' = -(2\pi rL)\kappa \frac{dT}{dr}$$

which we can integrate with respect to r from $r = a$ where $T = T_i$ to $r = b$ where $T = T_o$,

$$Q' \int_a^b \frac{dr}{r} = -2\pi L \kappa \int_{T_i}^{T_o} dT$$

i.e.

$$Q' = (T_i - T_o) \frac{2\pi\kappa L}{\ln\left(\frac{b}{a}\right)}$$

Thus the thermal resistance of the hollow cylindrical insulation is

$$\theta = \frac{(T_i - T_o)}{Q'} = \frac{\ln\left(\frac{b}{a}\right)}{2\pi\kappa L}$$

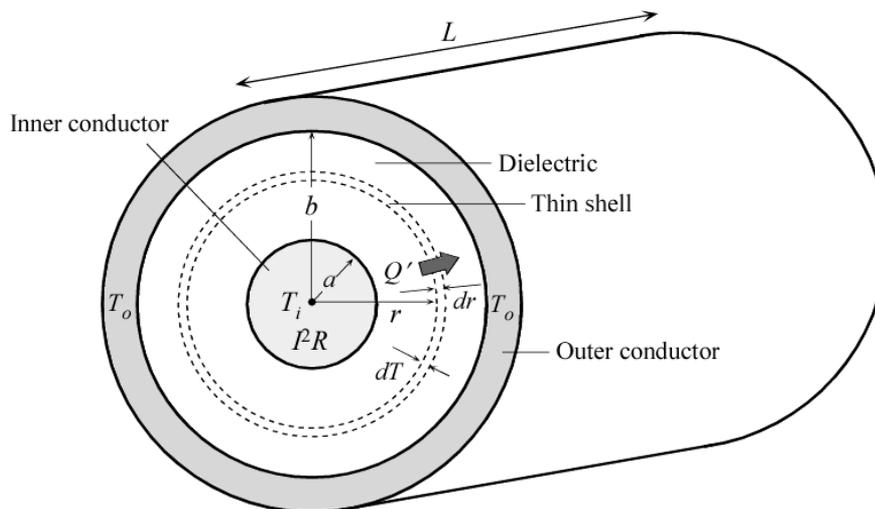

Figure 2Q29-1: Thermal resistance of a hollow cylindrical shell. Consider an infinitesimally thin cylindrical shell of radius r and thickness dr in the dielectric and concentrically around the inner conductor. The surface area is $2\pi rL$

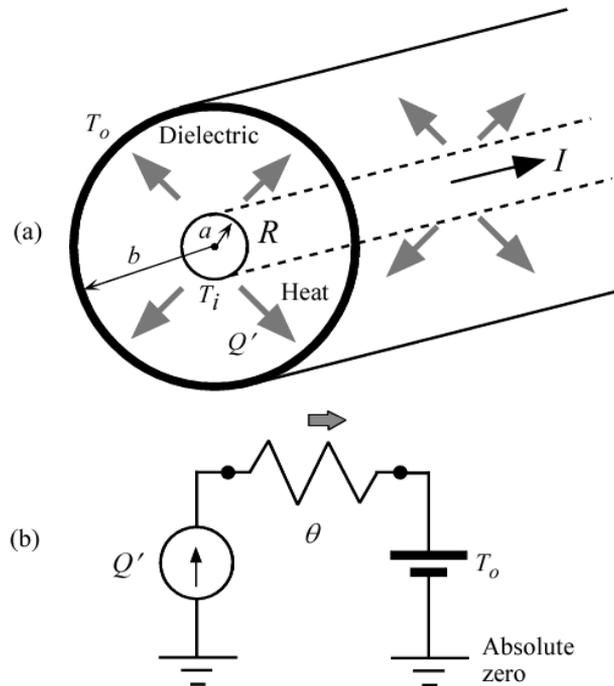

Figure 2Q29-2: (a) The joule heat generated in the core conductor flows outwards radially through the dielectric material. (b) The equivalent circuit.

The actual length of the conductor does not affect the calculations as long as the length is sufficiently long such that there is no heat transfer along the length; heat flows radially from the inner to the outer conductor. We consider a portion of length L of a very long cable and we set $L = 1$ m so that the calculations are per unit length. The joule heating per unit second (power) generated by the current I through the core conductor is

$$Q' = I^2 \frac{\rho L}{\pi a^2} = (500^2) \frac{(19 \times 10^{-9})(1)}{\pi(4 \times 10^{-3})^2} = \mathbf{94.5 \text{ W}}$$

The thermal resistance of the insulation is,

$$\theta = \frac{\ln\left(\frac{b}{a}\right)}{2\pi\kappa L} = \frac{\ln\left(\frac{(4 + 3.5) \times 10^{-3}}{4 \times 10^{-3}}\right)}{2\pi(0.3)(1)} = \mathbf{0.33 \text{ }^\circ\text{C/W}}$$

Thus, the temperature difference ΔT due to Q' flowing through θ is,

$$\Delta T = Q' \theta = (94.5 \text{ W})(0.33 \text{ }^\circ\text{C/W}) = \mathbf{31.2 \text{ }^\circ\text{C}}.$$

The inner temperature is therefore,

$$T_i = T_o + \Delta T = 25 + 31.2 = \mathbf{56.2 \text{ }^\circ\text{C}}.$$

Note that for simplicity we assumed that the inner conductor resistivity ρ and thermal conductivity κ are constant (do not change with temperature).

2.30 Temperature of a light bulb filament

- a. Consider a 100 W, 120 V incandescent bulb (lamp). The tungsten filament has a length of 0.579 m and a diameter of 63.5 μm . Its resistivity at room temperature is 56 n Ω m. Given that the resistivity of the filament can be represented as

$$\rho = \rho_0 \left[\frac{T}{T_0} \right]^n \quad \text{Resistivity of W} \quad [2.88]$$

where T is the temperature in K, ρ_0 is the resistance of the filament at T_0 K, and $n = 1.24$, estimate the temperature of the bulb when it is operated at the rated voltage, that is, directly from the mains outlet. Note that the bulb dissipates 100 W at 120 V.

- b. Suppose that the electrical power dissipated in the tungsten wire is totally radiated from the surface of the filament. The radiated power at the absolute temperature T can be described by Stefan's Law

$$P_{\text{radiated}} = \varepsilon \sigma_s A (T^4 - T_0^4) \quad \text{Radiated power} \quad [2.89]$$

where σ_s is Stefan's constant ($5.67 \times 10^{-8} \text{ W m}^{-2} \text{ K}^{-4}$), ε is the emissivity of the surface (0.35 for tungsten), A is the surface area of the tungsten filament, and T_0 is the room temperature (293 K). Obviously, for $T > T_0$, $P_{\text{radiated}} = \varepsilon \sigma_s A T^4$.

Assuming that all of the electrical power is radiated from the surface, estimate the temperature of the filament and compare it with your answer in part (a).

- c. If the melting temperature of W is 3407 $^{\circ}\text{C}$, what is the voltage that guarantees that the light bulb will blow?

Solution

- a. First, find the current through the bulb at 100 W and 120 V.

$$P = VI$$

$$\therefore I = P/V = (100 \text{ W})/(120 \text{ V}) = 0.8333 \text{ A}$$

From Ohm's law the resistance of the bulb can be found:

$$R = V/I = (120 \text{ V})/(0.8333 \text{ A}) = 144.0 \Omega$$

The values for length of the filament ($L = 0.579 \text{ m}$) and diameter of the filament ($D = 63.5 \mu\text{m}$) at operating temperature are given. Using these values we can find the resistivity of the filament when the bulb is on (ρ_1).

$$R = \frac{\rho_1 L}{\frac{\pi}{4} D^2}$$

$$\therefore \rho_1 = \frac{R \frac{\pi}{4} D^2}{L} = \frac{(144.0 \Omega) \frac{\pi}{4} (63.5 \times 10^{-6} \text{ m})^2}{(0.579 \text{ m})} = 7.876 \times 10^{-7} \Omega \text{ m}$$

Now the bulb's operating temperature (T_1) can be found using our values above in the equation for resistivity of W (assuming room temperature $T_0 = 293 \text{ K}$ and given $n = 1.24$):

$$\rho = \rho_0 \left[\frac{T}{T_0} \right]^n$$

$$\therefore T_1 = T_0 \left[\frac{\rho_1}{\rho_0} \right]^{\frac{1}{n}} = (293 \text{ K}) \left[\frac{7.876 \times 10^{-7} \Omega \text{ m}}{56 \times 10^{-9} \Omega \text{ m}} \right]^{\frac{1}{1.24}} = 2470 \text{ K}$$

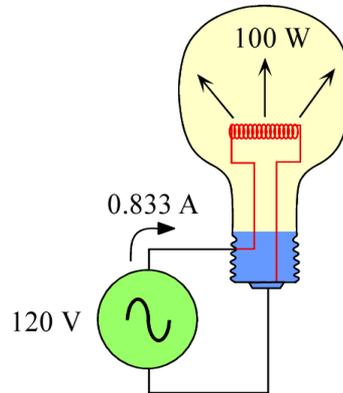

Figure 2Q30-1 Power radiated from a light bulb at 2570 °C is equal to the electrical power dissipated in the filament.

b. First we need the surface area A of the Tungsten filament. Since it is cylindrical in shape:

$$A = L(\pi D) = (0.579 \text{ m})(\pi)(63.5 \times 10^{-6} \text{ m}) = 0.0001155 \text{ m}^2$$

Now, the temperature of the filament T_1 can be found by assuming that all the electrical power delivered to the filament at T_1 is radiated away by Stefan's law. That is, P is the electrical power delivered to the filament

$$P = \varepsilon \sigma_s A (T_1^4 - T_0^4)$$

where A is the surface area of the filament, ε is the emissivity of tungsten and σ_s is Stefan's constant. Substitute $\varepsilon = 0.35$, $\sigma_s = 5.67 \times 10^{-8} \text{ W m}^{-2} \text{ K}^{-4}$, and room temperature ($T_0 = 293 \text{ K}$) into

$$P = \varepsilon \sigma_s A (T_1^4 - T_0^4)$$

and then solve for T_1 ,

$$\therefore T_1 = \left(\frac{P}{\varepsilon \sigma_s A} + T_0^4 \right)^{\frac{1}{4}}$$

$$\therefore T_1 = \left[\frac{100 \text{ W}}{(0.35)(5.67 \times 10^{-8} \text{ W m}^{-2} \text{ K}^{-4})(0.0001155 \text{ m}^2)} + (293 \text{ K})^4 \right]^{\frac{1}{4}}$$

$$\therefore T_1 = 2570 \text{ K}$$

Note: We can even ignore T_0 to get the same temperature since $T_0 \ll T_1$:

$$P = \varepsilon \sigma_s A T_1^4$$

$$\therefore T_1 = \left(\frac{P}{\varepsilon \sigma_s A} \right)^{\frac{1}{4}} = \left[\frac{100 \text{ W}}{(0.35)(5.67 \times 10^{-8} \text{ W m}^{-2} \text{ K}^{-4})(0.0001155 \text{ m}^2)} \right]^{\frac{1}{4}}$$

$$\therefore T_1 = 2570 \text{ K}$$

These values are fairly close to the answer obtained in part (a).

c. Let V be the voltage and R be the resistance when the filament is at temperature T_m . We are given the melting temperature, $T_m = 3407^\circ\text{C} + 273 = 3680\text{ K}$. Since we know the following:

$$R = \frac{L}{\frac{\pi}{4} D^2} \rho \quad \text{and} \quad \rho = \rho_0 \left[\frac{T_m}{T_0} \right]^n$$

We can make a substitution for ρ and use the values given for the light bulb filament to find the resistance of the filament at temperature T_m .

$$R = \frac{L}{\frac{\pi}{4} D^2} \rho_0 \left[\frac{T_m}{T_0} \right]^n = \frac{(0.579\text{ m})}{\frac{\pi}{4} (63.5 \times 10^{-6}\text{ m})^2} (56 \times 10^{-9}\ \Omega\text{ m}) \left[\frac{3680\text{ K}}{293\text{ K}} \right]^{1.24}$$

$$\therefore R = 236.03\ \Omega$$

Assuming that all electrical power is radiated from the surface of the bulb, we can use Stefan's law again. Substitute for R in V^2/R for the electrical power P delivered to the filament and hence radiated

$$\frac{V^2}{R} = \varepsilon \sigma_s A (T_1^4 - T_0^4)$$

$$\therefore V^2 = R \varepsilon \sigma_s A (T_m^4 - T_0^4)$$

$$\therefore V^2 = (236.03\ \Omega)(0.35)(5.67 \times 10^{-8}\ \text{W m}^{-2}\ \text{K}^{-4})(0.0001155\ \text{m})[(3680\ \text{K})^4 - (293\ \text{K})^4]$$

$$\therefore V = 315\ \text{V}$$

The voltage must be greater than 315 V

2.31 Superionic conduction in RbAg₄I₅ Figure 2.29 shows that the RbAg₄I₅ (rubidium silver iodide) crystal has a conductivity that is orders of magnitude higher than traditional ceramics and glasses in the same temperature range. Table 2.17 gives the conductivity of RbAg₄I₅ as a function of temperature. By carrying out a suitable plot, find the activation energy E_σ (eV) and the pre-exponential constant A in the expression for ionic conduction, $\sigma = (A/T)\exp(-E_\sigma/kT)$.

Table 2.17 Conductivity vs. temperature data for a RbAg₄I₅ crystal

T ($^\circ\text{C}$)	25	27	34	51	56	65	75	77
σ ($\Omega^{-1}\text{ cm}^{-1}$)	0.288	0.304	0.322	0.339	0.371	0.395	0.427	0.434
T ($^\circ\text{C}$)	87	89	92	107	121	132	134	147
σ ($\Omega^{-1}\text{ cm}^{-1}$)	0.455	0.465	0.477	0.527	0.55	0.581	0.608	0.659

Data extracted from K. S. Kim and W Piak, *J. Chem. Engin. Data* **20**, 356 1975

Solution

The data in Table 2.17 is reproduced in Table 2Q31 in Excel with the required quantities σT and $1/T$ calculated. The semilogarithmic plot of conductivity \times temperature product (σT) against reciprocal temperature ($10^3/T$) is shown in Figure 2Q31.

Table 2Q31 Conductivity at various temperatures for RbAg₄I₅ crystal

UNITS	°C	1/(Ohm cm)	K	1/K	K/(Ohm cm)
QUANTITY	T	Conductivity	T (K)	$1/T$	σT
VALUES	25	0.288	298	3.3557047	85.824
	27	0.304	300	3.33333333	91.2
	34	0.322	307	3.25732899	98.854
	51	0.339	324	3.08641975	109.836
	56	0.371	329	3.03951368	122.059
	65	0.395	338	2.95857988	133.51
	87	0.455	360	2.77777778	163.8
	89	0.465	362	2.76243094	168.33
	92	0.477	365	2.73972603	174.105
	107	0.527	380	2.63157895	200.26
	121	0.55	394	2.53807107	216.7
	132	0.581	405	2.4691358	235.305
	134	0.608	407	2.45700246	247.456

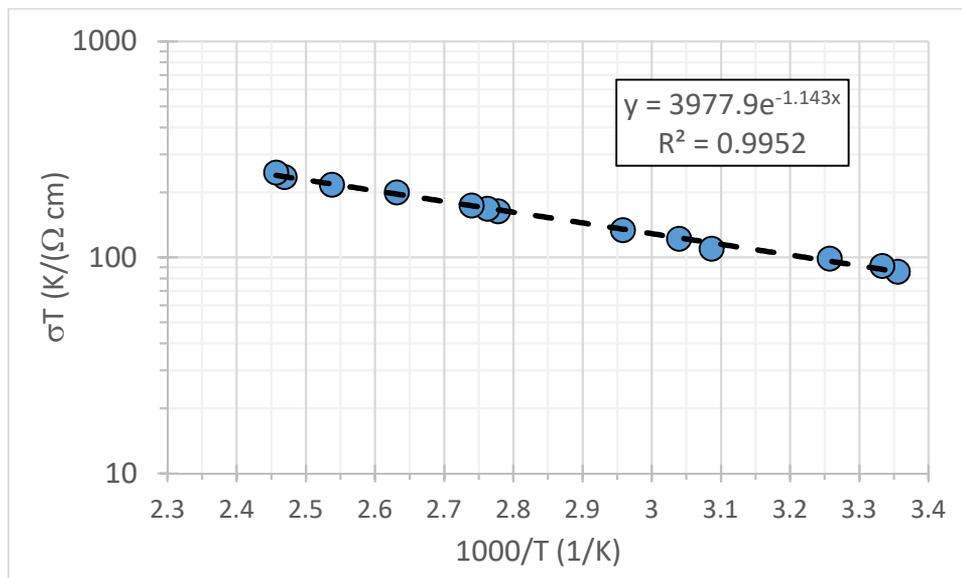
**Figure 2Q31** A semilogarithmic plot of conductivity × temperature product (σT) against reciprocal temperature ($10^3/T$).

We expect the conductivity to follow

$$\sigma = \frac{A}{T} \exp\left(-\frac{E_{\sigma}}{kT}\right) \quad (1)$$

So that taking the natural logs of both sides, we find

$$\ln(\sigma T) = -\frac{E_{\sigma}}{kT} + \ln A \quad (2)$$

The observed straight line in Figure 2Q31 confirms the above behavior. From the best fit exponential line in Figure 2Q31 (in Excel), the slope is

$$\text{Slope} = -1.143 \times 10^3 \text{ K}^{-1},$$

$$\therefore E_{\sigma} \text{ (eV)} = -\text{Slope} \frac{k}{e} = -(-.143 \times 10^3 \text{ K}^{-1}) \frac{(1.381 \times 10^{-23} \text{ J K}^{-1})}{(1.602 \times 10^{-19} \text{ J eV}^{-1})}$$

$$\therefore E_{\sigma} = \mathbf{0.099 \text{ eV.}}$$

The pre-exponential in the best fit exponential function is

$$A = \mathbf{3978 \text{ K } \Omega^{-1} \text{ cm}^{-1}}.$$

Note: We can check that the above values are correct by, for example, calculating the conductivity at $T = 360 \text{ K}$. Substituting $T = 360 \text{ K}$, we have

$$\begin{aligned} \sigma &= \frac{(3978 \text{ K } \Omega^{-1} \text{ cm}^{-1})}{T} \exp\left(-\frac{(0.98 \text{ eV})}{kT}\right) \\ \therefore &= \frac{(3978 \text{ K } \Omega^{-1} \text{ cm}^{-1})}{(360 \text{ K})} \exp\left[-\frac{(0.98 \text{ eV})(1.602 \times 10^{-19} \text{ J eV}^{-1})}{(1.38 \times 10^{-23} \text{ J K}^{-1})(360 \text{ K})}\right] \\ &= 0.454 \text{ } \Omega^{-1} \text{ cm}^{-1}, \text{ which is the value in Table 2Q31.} \end{aligned}$$

2.32 Hall effect with ions in ionic crystals By using various sensitive measurement techniques, it is possible to carry out Hall effect measurements on certain ionic crystals. Stuhmann, Kreiterling and Funke in 2002 (*Solid State Ionics*, 154, 109) were able to measure the Hall voltage on superionic RbAg_4I_5 crystals in a magnetic field. The results at $100 \text{ }^\circ\text{C}$ indicate that the Hall coefficient is approximately $5.7 \times 10^{-4} \text{ cm}^3 \text{ C}^{-1}$. The conductivity of the sample at the same temperature is approximately $0.53 \text{ } \Omega^{-1} \text{ cm}^{-1}$. The mobile charges are Ag^+ ions. What is the Hall mobility of Ag^+ ions? The Ag^+ concentration in the crystal can be estimated from the density of the crystal ($d = 5.38 \text{ g cm}^{-3}$) and is approximately $1.13 \times 10^{22} \text{ cm}^{-3}$. Assuming that all the ions are moving, what should be the drift mobility of Ag^+ ions at $100 \text{ }^\circ\text{C}$? What is your conclusion?

Solution

The Hall mobility is given by the product of conductivity and the Hall coefficient, that is

$$\mu_H = \sigma R_H = (0.53 \text{ } \Omega^{-1} \text{ cm}^{-1})(5.7 \times 10^{-4} \text{ cm}^3 \text{ C}^{-1}) = 3.02 \times 10^{-4} \text{ cm}^2 \text{ V}^{-1} \text{ s}^{-1}$$

Consider now the conductivity σ due to the drift of Ag^+ ions. Let $n(\text{Ag}^+)$ be the concentration of Ag^+ ions drifting, then

$$\sigma = en\mu_d = en(\text{Ag}^+)\mu_d$$

from which we can find the drift mobility μ_d ,

$$\mu_d = \frac{\sigma}{en(\text{Ag}^+)} = \frac{(0.53 \text{ } \Omega^{-1} \text{ cm}^{-1})}{(1.602 \times 10^{-19} \text{ C})(1.13 \times 10^{22} \text{ cm}^{-3})} = 2.93 \times 10^{-4} \text{ cm}^2 \text{ V}^{-1} \text{ s}^{-1}$$

The agreement is excellent and confirms that nearly all Ag^+ are drifting.

Comment: The data were extracted from Figure 3 and 4 in Stuhmann, Kreiterling and Funke in *Solid State Ionics*, 154, 109, 2002, where their conclusion is that the two mobilities, Hall and drift, are the same, exactly as above. Note that there are 4 (RbAg_4I_5) units in the cubic unit cell of the RbAg_4I_5 crystal. The lattice parameter a is 0.1124 nm , so we can calculate the number of Ag^+ -ions per unit volume as $4 \times (4/a^3)$ or $1.13 \times 10^{22} \text{ cm}^{-3}$.

2.33 Ionic conduction in soda-silicate glasses Consider soda-silica glass of composition 25%Na₂O-75%SiO₂ which represents (Na₂O)_{0.25}(SiO₂)_{0.75}. Its density is 2.39 g cm⁻³. The diffusion coefficient D of Na⁺ in this soda-silica at 350 °C is 3.38×10^{-9} cm² s⁻¹ and the Haven ratio f is 0.53. Calculate the conductivity of 25%Na₂O-75%SiO₂ glass at 350 °C and compare it the value deduced from Figure 2.29.

Solution

Following Example 2.25, we first calculate the concentration of Na⁺ ions in the glass. If M_{Na} , M_{Si} and M_{O} are the atomic masses of Na, Si and O respectively, the molecular mass of (Na₂O)_{0.25}(SiO₂)_{0.75} is

$$\begin{aligned} M &= 0.25(2M_{\text{Na}} + M_{\text{O}}) + 0.75(M_{\text{Si}} + 2M_{\text{O}}) \\ &= 0.25(2 \times 23.0 + 16.0) + 0.75(28.1 + 2 \times 16) = 60.6 \text{ g mol}^{-1} \end{aligned}$$

Given the density d , the concentration of (Na₂O)_{0.25}(SiO₂)_{0.75} units ("molecules") is

$$n_{\text{molecule}} = \frac{dN_A}{M} = \frac{(2.39 \text{ g cm}^{-3})(6.022 \times 10^{23} \text{ mol}^{-1})}{(60.6 \text{ g mol}^{-1})} = 2.38 \times 10^{22} \text{ cm}^{-3}$$

Each of these (Na₂O)_{0.25}(SiO₂)_{0.75} units has 0.25×2 number of Na atoms so that the Na⁺-ion concentration is

$$n_i = 0.25 \times 2 \times 2.38 \times 10^{22} \text{ cm}^{-3} = 1.19 \times 10^{22} \text{ cm}^{-3}.$$

We need the drift mobility μ_i of the Na⁺ ions, which is

$$\mu_i = \frac{1}{f} \left(\frac{e}{kT} \right) D_i = \frac{1}{0.53} \left[\frac{(1.602 \times 10^{-19} \text{ C})}{(1.381 \times 10^{-23} \text{ J K}^{-1})(360 + 273 \text{ K})} \right] (3.38 \times 10^{-8} \text{ cm}^2 \text{ s}^{-1})$$

$$\therefore \mu_i = 1.235 \times 10^{-7} \text{ cm}^2 \text{ s}^{-1}$$

The conductivity is

$$\sigma = en_i\mu_i = (1.602 \times 10^{-19} \text{ C})(1.19 \times 10^{22} \text{ cm}^{-3})(1.235 \times 10^{-7} \text{ cm}^2 \text{ s}^{-1}) = 2.35 \times 10^{-4} \Omega^{-1} \text{ cm}^{-1}$$

Consider 24%Na₂O-76%SiO₂ in Figure 2.29, which is almost the same as the composition 25%Na₂O-75%SiO₂. The conductivity of 24%Na₂O-76%SiO₂ in Figure 2.29 at 350 C is roughly 2×10^{-4} W⁻¹ cm⁻¹. Given the uncertainty in reading off the conductivity scale in Figure 2.29, the agreement is very good.

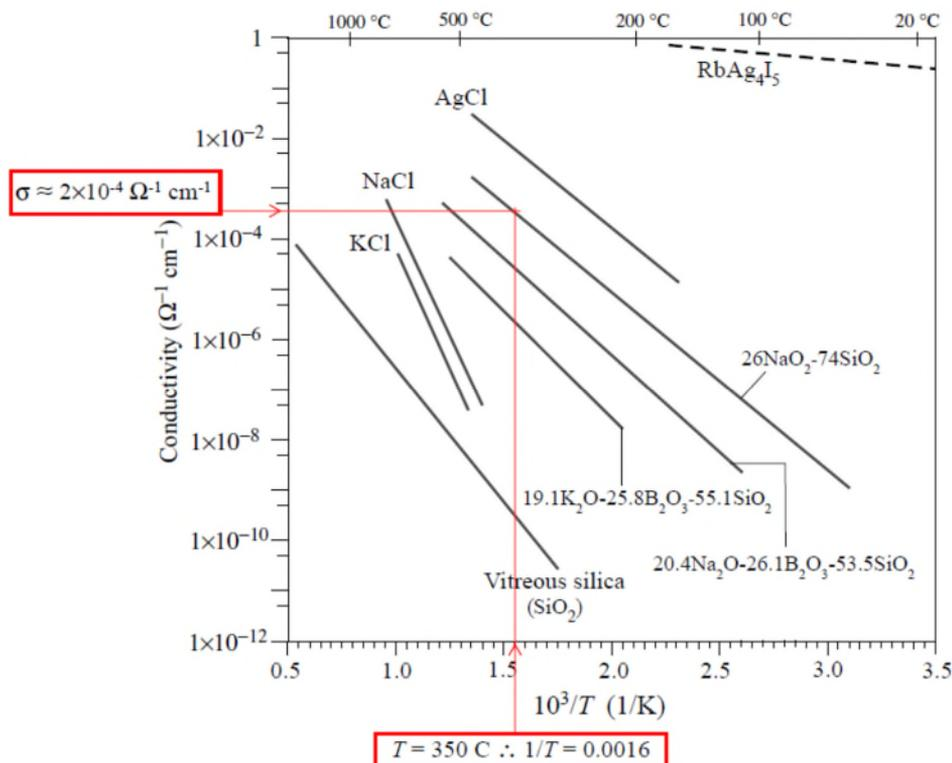

Figure 2Q33-1 (Figure 2.29 in the 4th Edition.) The composition 24%Na₂O-76%SiO₂ in this figure (Figure 2.29) is almost the same as the composition 25%Na₂O-75%SiO₂. Its conductivity at 350 C is roughly 2 × 10⁻⁴ W⁻¹ cm⁻¹.

Note: The Na⁺ diffusion coefficient *D* in silica is from Table I in C. Lim and D.E. Day, "Sodium Diffusion in Glass: I, Single-Alkali Silicate", *J. Am. Ceram Soc.*, 60, 198-203, 1977. Their table of values is reproduced below.

<i>T</i> °C	1/ <i>T</i> (10 ³ /K)	<i>D</i> (cm ² s ⁻¹)
300	1.745201	9.10E-10
350	1.605136	3.38E-09
400	1.485884	1.03E-08
430	1.422475	1.87E-08

2.34 Ionic conduction in borosilicate glasses Table 2.18 shows the conductivities of four types of borosilicate glass identified as samples L,N, K and C where L is 53.4SiO₂-25.8B₂O₃-20.8Li₂O, N is 53.5SiO₂-26.1B₂O₃-20.4Na₂O; K is 55.1SiO₂-25.8B₂O₃-19.1K₂O and C is 58.1SiO₂-24.7B₂O₃-17.2Na₂O. The numbers represent molar percentages *i.e.* 55.1%SiO₂ *etc.* The main difference between the samples is the alkaline ion species: L has Li⁺, N has Na⁺, K has K⁺ and C has Cs⁺ mobile ions.

- a Find the constant *A*, the activation energy *E*_σ for each sample. Plot *E*_σ vs. the alkaline ion radius.
- b Calculate and compare the conductivities at the same temperature, say at 400 °C. Which are lower? Why? Plot semilogarithmically σ at 400 °C vs. ionic radius.

c Find approximately the temperature for each glass so that all four glasses at this temperature have the same conductivity of $\sigma = 8.00 \times 10^{-6} \Omega^{-1} \text{ cm}^{-1}$. For example, T is 235 °C for glass L. What is your conclusion?

Table 2.18 Selected conductivities and properties of borosilicate glasses with different alkaline ions

Sample	Mobile ion	Ionic radius (nm)	σ_1 at T_1 $\Omega^{-1} \text{ cm}^{-1}$	σ_2 at T_2 $\Omega^{-1} \text{ cm}^{-1}$
L	Li ⁺	0.061	9.18×10^{-6} at 240 °C	8.86×10^{-4} at 490 °C
N	Na ⁺	0.086	1.54×10^{-7} at 190 °C	2.34×10^{-4} at 500 °C
K	K ⁺	0.139	2.22×10^{-8} at 220 °C	1.25×10^{-4} at 520 °C
C	Cs ⁺	0.160	5.43×10^{-9} at 230 °C	9.50×10^{-6} at 500 °C

Note: Conductivity and ionic radius values from M. Neyret *et al*, *J. Non-Cryst. Solids*, **410**, 74 (2015)

Solution

a. This problem is identical to Example 2.24, that is, at temperature T_1 , $\sigma = \sigma_1$ and at T_2 , $\sigma = \sigma_2$,

$$\sigma_1 = \frac{A}{T_1} \exp\left(-\frac{E_\sigma}{kT_1}\right) \quad \text{and} \quad \sigma_2 = \frac{A}{T_2} \exp\left(-\frac{E_\sigma}{kT_2}\right)$$

We have two equations with two unknowns (E_σ and A). Dividing first by the second eliminates A and then we can solve for E_σ to find

$$E_\sigma = \frac{kT_1T_2}{(T_2 - T_1)} \ln\left(\frac{\sigma_2T_2}{\sigma_1T_1}\right)$$

from which we can calculate E_σ . Then, we can use any one of the equations to find A ,

$$A = \sigma_1 T_1 \exp\left(\frac{E_\sigma}{kT_1}\right)$$

The results of the calculations are summarized in Table 2Q34-1. The plot of E_σ vs the ionic radius is shown in Figure 2Q34-1. Clearly, as the ionic radius increases (the size of the ion), the activation energy also increases. It becomes harder for the ion to diffuse.

Table 2Q34-1 Selected conductivities and properties of borosilicate glasses with different alkaline ions and the results of the calculations of E_σ , A and σ at 400 °C

Sample	Mobile ion	Ionic radius (nm)	σ_1 at T_1 $\Omega^{-1} \text{ cm}^{-1}$	σ_2 at T_2 $\Omega^{-1} \text{ cm}^{-1}$	E_σ (eV)	A ($\text{K } \Omega^{-1} \text{ cm}^{-1}$)	σ ($\Omega^{-1} \text{ cm}^{-1}$) at 400 °C
L	Li ⁺	0.061	9.18×10^{-6} at 240 °C	8.86×10^{-4} at 490 °C	0.67	1.80×10^4	2.57×10^{-4}
N	Na ⁺	0.086	1.54×10^{-7} at 190 °C	2.34×10^{-4} at 500 °C	0.78	2.20×10^4	4.72×10^{-5}
K	K ⁺	0.139	2.22×10^{-8} at 220 °C	4.64×10^{-5} at 520 °C	0.91	2.30×10^4	5.35×10^{-6}
C	Cs ⁺	0.160	5.43×10^{-9} at 230 °C	9.50×10^{-6} at 500 °C	0.98	1.80×10^4	1.26×10^{-6}

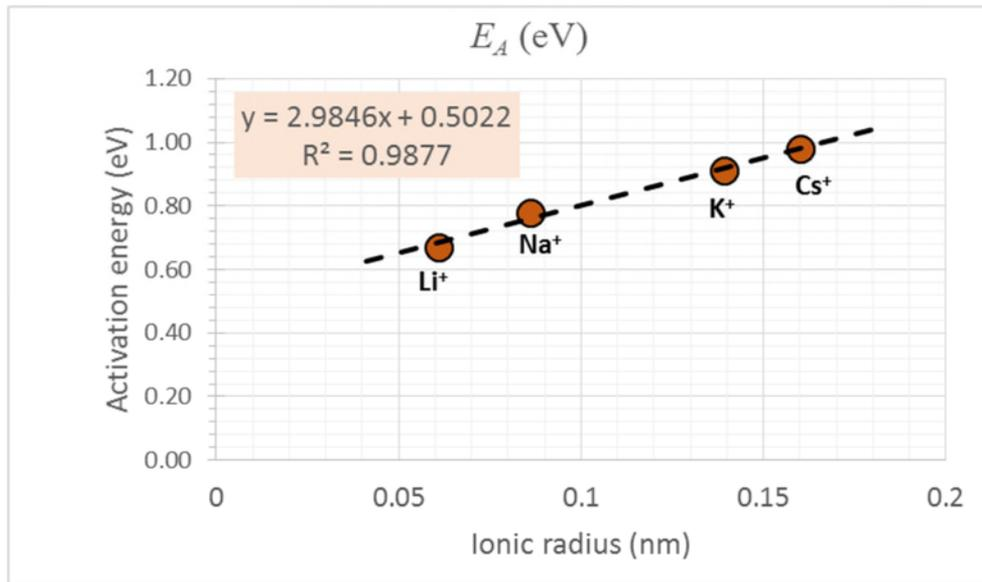

Figure 2Q34-1 A plot of the activation energy E_A (eV) vs. ionic radius (nm) of drifting ions in the glass

b. Since the temperature is given, and we know A and E_σ for each, we can calculate the σ at 400 °C, σ_{400} , from

$$\sigma_{400} = \frac{(1.8 \times 10^4 \text{ K}\Omega^{-1}\text{cm}^{-1})}{(400 + 273\text{K})} \exp\left(-\frac{(0.67\text{eV})}{(4.9 \times 10^{-4} \text{ eV K}^{-1})(400 + 273\text{K})}\right) = 2.57 \times 10^{-4} \Omega^{-1} \text{ cm}^{-1}$$

This and the results for the other ions are listed in Table 2Q34-1. We can now plot semilogarithmically σ_{400} vs. the ion radius as in Figure 2Q34-2. Clearly, there is an exponential decay in the conductivity as the ion size increases. This is not surprising because the activation energy E_σ increases linearly with the ionic radius. The conductivity $\sigma = (A/T)\exp(-E_\sigma/kT)$ but A is relatively independent of the ionic radius as can be seen from Table 2Q34-1. Thus, the exponential drop in the conductivity along Li^+ , Na^+ , K^+ and Cs^+ ions is due to the activation energy increasing linearly with the ionic radius.

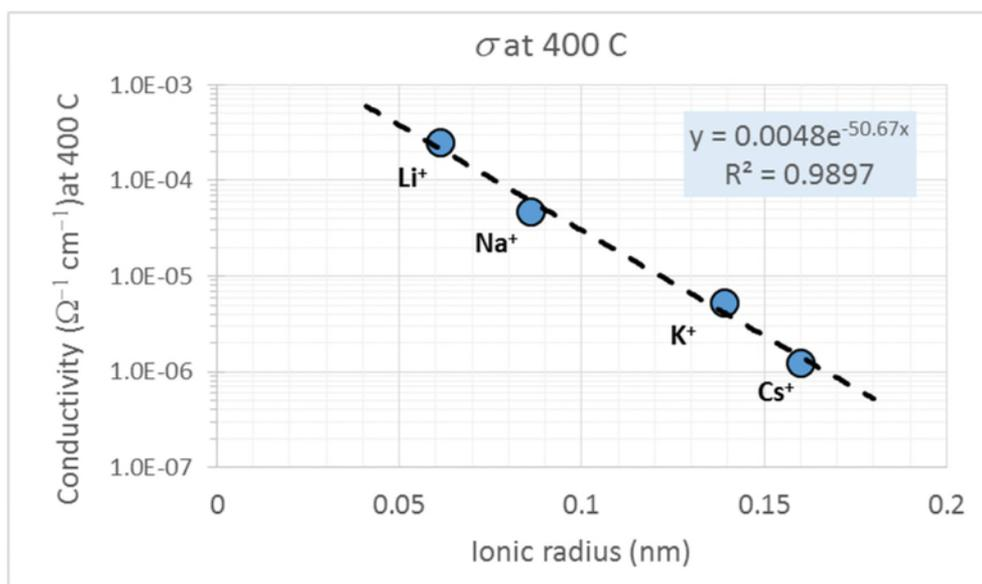

Figure 2Q34-2 A semilogarithmic plot of conductivity at 400 °C vs ionic radius of drifting ions in the glass

Table 2Q34-1 Selected conductivities and properties of borosilicate glasses with different alkaline ions

Sample	Mobile ion	Ionic radius (nm)	E_{σ} (eV)	A ($\text{K } \Omega^{-1} \text{ cm}^{-1}$)	σ at 400 °C ($\Omega^{-1} \text{ cm}^{-2}$)	T for $\sigma = 8.00 \times 10^{-6} \Omega^{-1} \text{ cm}^{-1}$
L	Li^+	0.061	0.67	1.80×10^4	2.57×10^{-4}	235 °C
N	Na^+	0.086	0.78	2.20×10^4	4.72×10^{-5}	316 °C
K	K^+	0.139	0.91	2.30×10^4	5.35×10^{-6}	420 °C
C	Cs^+	0.160	0.98	1.80×10^4	1.26×10^{-6}	490 °C

c. To calculate the temperature at which $\sigma = 8 \times 10^{-6} \Omega^{-1} \text{ cm}^{-1}$, we need to solve

$$\sigma = 8 \times 10^{-6} \Omega^{-1} \text{ cm}^{-1} = \frac{A}{T} \exp\left(-\frac{E_{\sigma}}{kT}\right)$$

for a given set of E_A and A from Table 2Q34-1. For example, for Li, we can write this as

$$\sigma = (8 \times 10^{-6} \Omega^{-1} \text{ cm}^{-1}) = \frac{(1.8 \times 10^4 \text{ K } \Omega^{-1} \text{ cm}^{-1})}{T} \exp\left(-\frac{(0.67 \text{ eV})}{(4.9 \times 10^{-4} \text{ eV K}^{-1})T}\right)$$

which can be solved only numerically or by graphing the function. The exponential part $\exp(-E_{\sigma}/kT)$ dominates the temperature dependence of σ rather than the pre-exponential part A/T . Thus, we can take an initial guess for $T = T_1 =$ (for example) 400 °C, and then use this in the pre-exponential part (A/T) and calculate T from the exponential part, *i.e.*

$$\sigma = \frac{A}{T_1} \exp\left(-\frac{E_{\sigma}}{kT_1}\right)$$

$$\therefore T = \frac{E_{\sigma}}{k \ln(\sigma T_1 / A)} = \frac{(0.67 \text{ eV})}{(4.9 \times 10^{-4} \text{ eV K}^{-1}) \ln \left[\frac{(8 \times 10^{-6} \Omega^{-1} \text{ cm}^{-1})(400 + 273 \text{ K})}{(1.8 \times 10^4 \text{ K } \Omega^{-1} \text{ cm}^{-1})} \right]} = 517.6 \text{ K}$$

We can now take this value, 517.6 K, as a better initial guess for T_1 and recalculate a new T , *i.e.*

$$T = \frac{E_{\sigma}}{k \ln(\sigma T_1 / A)} = \frac{(0.67 \text{ eV})}{(4.9 \times 10^{-4} \text{ eV K}^{-1}) \ln \left[\frac{(8 \times 10^{-6} \Omega^{-1} \text{ cm}^{-1})(517.6 \text{ K})}{(1.8 \times 10^4 \text{ K } \Omega^{-1} \text{ cm}^{-1})} \right]} = 508.6 \text{ K}$$

Of course, we can repeat the above by taking an even better guess for T_1 as 508.7 K, so that

$$T = \frac{E_{\sigma}}{k \ln(\sigma T_1 / A)} = \frac{(0.67 \text{ eV})}{(4.9 \times 10^{-4} \text{ eV K}^{-1}) \ln \left[\frac{(8 \times 10^{-6} \Omega^{-1} \text{ cm}^{-1})(508.7 \text{ K})}{(1.8 \times 10^4 \text{ K } \Omega^{-1} \text{ cm}^{-1})} \right]} = 508.1$$

Clearly the calculations have now converged to a value 508.1 K that is 235 °C. This value is entered into Table 2Q34-2. Similar calculations for the other 3 ions lead to the temperatures shown in Table 2Q34-2. The Livemath (formerly, Theorist) calculations are given below.

2Q34 Ionic conduction part c for Li

Find T_x = Unknown temperature for a given conductivity σ

Consider Li

$\sigma = 8 \times 10^{-6}$

$A = 18000$

$E_a = 0.67$

In $\sigma = (A/T)\exp(-E_a/kT)$, the exponential part is the most sensitive part to temperature changes. The pre-exponential term (A/T) is the least sensitive.

T_{x0} is an initial guess (any value will do). Use this in the pre-exponential term (A/T_x), which does not greatly affect the overall conductivity compared with the exponential term. Thus, our initial guess is

$T_{x0} = 400$ deg C

The conductivity at T_x is

$$\sigma = \frac{A}{T_{x0} + 273} \exp\left(-\frac{E_a q}{k_B [T_x + 273]}\right)$$

$$\Delta T_x = -\frac{E_a q}{k_B \ln\left(\frac{\sigma [T_{x0} + 273]}{A}\right)} - 273 \quad \text{Isolate}$$

$\Delta T_x = 244.56$ deg C

Clearly a better guess for T_{x0} is now T_x

$T_{x0}' = T_x$

A better value for T_x is now T_x' , given by

$$T_x' = -\frac{E_a q}{k_B \ln\left(\frac{\sigma [T_{x0}' + 273]}{A}\right)} - 273$$

$T_x' = 235.66$ deg C

A better guess for T_{x0} is now T_x'

$T_{x0}'' = T_x'$

A better value for T_x is now T_x'' , given by

$$T_x'' = -\frac{E_a q}{k_B \ln\left(\frac{\sigma [T_{x0}'' + 273]}{A}\right)} - 273$$

$T_x'' = 235.09$ deg C

After 2 iterations (3 calculations) the result has converged to $T_x'' = 235$ deg C

=====

We can also solve $\sigma = (A/T)\exp(-Ea/kT) = \text{RHS}$, by plotting this function. Let zero be defined as below, that is zero = $\sigma - (A/T)\exp(-Ea/kT)$. The solution is where zero crosses the zero x-axis. θ is temperature in deg C

$$\square \sigma = \frac{A}{\theta + 273} \exp\left(-\frac{Ea q}{kB[\theta + 273]}\right)$$

$$\square \text{zero} = \sigma - \frac{A}{\theta + 273} \exp\left(-\frac{Ea q}{kB[\theta + 273]}\right)$$

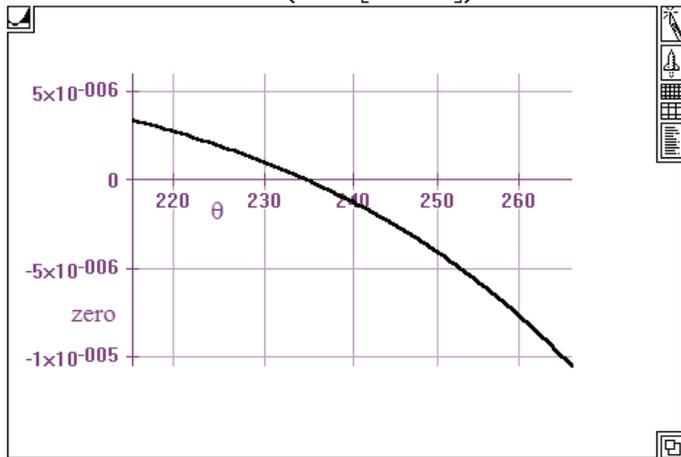

Clearly $\theta = 235$ deg C is a solution

2.35 Skin effect

- What is the skin depth for a copper wire carrying a current at 60 Hz? The resistivity of copper at 27 °C is 17 nΩ m. Its relative permeability is $\mu_r \approx 1$. Is there any sense in using a conductor for power transmission with a diameter of more than 2 cm?
- What is the skin depth for an iron wire carrying a current at 60 Hz? The resistivity of iron at 27 °C is 97 nΩ m. Assume that its relative permeability is $\mu_r \approx 700$. How does this compare with the copper wire? Discuss why copper is preferred over iron for power transmission even though the iron is nearly 100 times cheaper than copper.

Solution

a. The conductivity is $1/\rho$. The relative permeability (μ_r) for copper is 1, thus $\mu_{\text{Cu}} = \mu_0$. The angular frequency is $\omega = 2\pi f = 2\pi(60 \text{ Hz})$. Using these values in the equation for skin depth (δ):

$$\delta = \frac{1}{\sqrt{\frac{1}{2}\omega_0 \frac{1}{\rho} \mu_{\text{Cu}}}} = \frac{1}{\sqrt{\frac{1}{2}(2\pi 60 \text{ s}^{-1}) \left(\frac{4\pi \times 10^{-7} \text{ H m}^{-1}}{17 \times 10^{-9} \Omega \text{ m}}\right)}}$$

$$\therefore \delta = \mathbf{0.00847 \text{ m} \text{ or } 8.47 \text{ mm}}$$

This is the depth of current flow. If the radius of wire is 10 mm or more, no current flows through the core region and it is wasted. There is no point in using wire much thicker than a radius of 10 mm (diameter of 20 mm).

b. The conductivity is $1/\rho$. The relative permeability (μ_r) for Iron is 700, thus $\mu_{Fe} = 700\mu_0$. The angular frequency is $\omega = 2\pi f = 2\pi(60 \text{ Hz})$. Using these values in the equation for skin depth (δ):

$$\delta_{Fe} = \frac{1}{\sqrt{\frac{1}{2}\omega_0 \frac{1}{\rho} \mu_{Fe}}} = \frac{1}{\sqrt{\frac{1}{2}(2\pi 60 \text{ s}^{-1}) \frac{(700)(4\pi \times 10^{-7} \text{ H m}^{-1})}{(97 \times 10^{-9} \text{ } \Omega \text{ m})}}}$$

$$\therefore \delta = \mathbf{0.000765 \text{ m or } 0.765 \text{ mm}}$$

Thus the skin depth is 0.765 mm, about 11 times less than that for copper.

To calculate the resistance we need the cross sectional area for conduction. The material cross sectional area is πr^2 where r is the radius of the wire. But the current flow is within depth δ . We deduct the area of the core, $\pi(\rho - \delta)^2$, from the overall area, πr^2 , to obtain the cross sectional area for conduction.

Comparison of Cu and Fe based on solid core wires:

The resistance per unit length of the solid core Fe wire (R_{Fe}) is:

$$R_{Fe} = \frac{\rho_{Fe}}{A_{Fe}} = \frac{\rho_{Fe}}{\pi r_{Fe}^2 - \pi(r_{Fe} - \delta_{Fe})^2} = \frac{\rho_{Fe}}{2\pi r_{Fe} \delta_{Fe} - \pi \delta_{Fe}^2}$$

The resistance per unit length of solid core Cu wire is:

$$R_{Cu} = \frac{\rho_{Cu}}{A_{Cu}} = \frac{\rho_{Cu}}{\pi r_{Cu}^2 - \pi(r_{Cu} - \delta_{Cu})^2} = \frac{\rho_{Cu}}{2\pi r_{Cu} \delta_{Cu} - \pi \delta_{Cu}^2}$$

If we equate these two resistances, we can make a comparison between Fe and Cu:

$$R_{Fe} = R_{Cu}$$

$$\therefore \frac{\rho_{Fe}}{2\pi r_{Fe} \delta_{Fe} - \pi \delta_{Fe}^2} = \frac{\rho_{Cu}}{2\pi r_{Cu} \delta_{Cu} - \pi \delta_{Cu}^2}$$

$$\therefore 2\pi \rho_{Cu} r_{Fe} \delta_{Fe} = \rho_{Fe} (2\pi r_{Cu} \delta_{Cu} - \pi \delta_{Cu}^2) \quad (\text{Neglect the } \delta_{Fe}^2 \text{ term which is small})$$

$$\therefore r_{Fe} = \frac{\rho_{Fe} (2\pi r_{Cu} \delta_{Cu} - \pi \delta_{Cu}^2)}{2\pi \rho_{Cu} \delta_{Fe}}$$

We can assume a value for r_{Cu} for calculation purposes, $r_{Cu} = 10 \text{ mm}$. The resistivity ρ_{Cu} is given as 17 n Ω m and the skin depth of Cu is known to be $\delta_{Cu} = 8.47 \text{ mm}$. The resistivity of Fe is given as $\rho_{Fe} = 97 \text{ n}\Omega \text{ m}$ and its skin depth was just calculated to be $\delta_{Fe} = 0.765 \text{ mm}$. We can substitute these values into the above equation to determine the radius of Fe wire that would be equivalent to 10 mm diameter Cu wire.

$$r_{Fe} = \frac{(97 \times 10^{-9} \text{ } \Omega \text{ m}) [2\pi (0.010 \text{ m})(0.00847 \text{ m}) - \pi (0.00847 \text{ m})^2]}{2\pi (17 \times 10^{-9} \text{ } \Omega \text{ m})(0.000765 \text{ m})}$$

$$\therefore r_{Fe} = \mathbf{0.364 \text{ m}}$$

Now compare the volume (V) of Fe per unit length to the volume of Cu per unit length:

$$\frac{V_{\text{Fe}}}{V_{\text{Cu}}} = \frac{\pi r_{\text{Fe}}^2 (1 \text{ m})}{\pi r_{\text{Cu}}^2 (1 \text{ m})} = \frac{(0.364 \text{ m})^2}{(0.010 \text{ m})^2} = 1325$$

Even though Fe costs 100 times less than Cu, we need about 1300 times the volume of Cu if Fe is used. The cost disadvantage is 13 times in addition to weight disadvantage.

ADDENDUM JANUARY 2001 (A Discussion by Dr. George Belev)

Comparison of Cu and Fe wires: any shape and any number:

To determine if it is worthwhile to use iron rather than copper, we must compare the amount of iron needed to perform the equivalent task of some amount of copper (*i.e.* have the same resistance). Let us first assume that by choosing a proper shape for the conductors we can *eliminate* the influence of the skin effect on conduction.

The resistance per unit length of the Fe wire (R_{Fe}) is:

$$R_{\text{Fe}} = \frac{\rho_{\text{Fe}}}{A_{\text{Fe}}}$$

The resistance per unit length of Cu wire is

$$R_{\text{Cu}} = \frac{\rho_{\text{Cu}}}{A_{\text{Cu}}}$$

If we equate these two resistances, we can make a direct comparison between Fe and Cu:

$$R_{\text{Fe}} = R_{\text{Cu}}$$

$$\therefore A_{\text{Fe}} = \frac{\rho_{\text{Fe}}}{\rho_{\text{Cu}}} A_{\text{Cu}}$$

and the volumes of iron and copper per unit length will be in the same ratio

$$V_{\text{Fe}} = \frac{\rho_{\text{Fe}}}{\rho_{\text{Cu}}} V_{\text{Cu}}$$

Let us compare the masses of Fe and Cu needed per unit length

$$\frac{M_{\text{Fe}}}{M_{\text{Cu}}} = \frac{V_{\text{Fe}} D_{\text{Fe}}}{V_{\text{Cu}} D_{\text{Cu}}} = \frac{\rho_{\text{Fe}} D_{\text{Fe}}}{\rho_{\text{Cu}} D_{\text{Cu}}} = \frac{97 \text{ n}\Omega\text{m}}{17 \text{ n}\Omega\text{m}} \cdot \frac{7.86 \text{ gcm}^{-3}}{8.96 \text{ gcm}^{-3}} \approx 5$$

Since Fe costs 100 times less than Cu, if we use iron conductors, we will reduce the cost for wire by $100/5 = 20$ times. So it seems that the use of Fe will have great economic advantage if we can find a reasonable way to eliminate the influence of the skin effect on conduction.

There is no sense in making the conductor with a radius bigger than the skin depth, so let us consider a single copper conductor with radius δ_{Cu} , and using N iron conductors each with radius δ_{Cu} as shown bellow in Figure 2Q35-1,

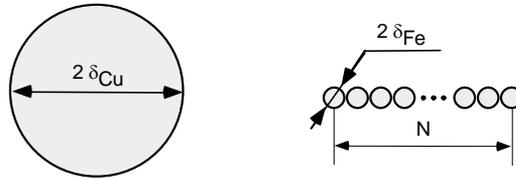

Figure 2Q35-1

As we have calculated above both conductors will have equal resistance per unit length if

$$\frac{A_{\text{Fe}}}{A_{\text{Cu}}} = \frac{N\pi\delta_{\text{Fe}}^2}{\pi\delta_{\text{Cu}}^2} = \frac{\rho_{\text{Fe}}}{\rho_{\text{Cu}}}$$

and we can calculate the number N of Fe wires that should run in parallel

$$N = \frac{\rho_{\text{Fe}}}{\rho_{\text{Cu}}} \frac{\delta_{\text{Cu}}^2}{\delta_{\text{Fe}}^2} \approx 700$$

Thus, copper as a single conductor has 700 times better performance than a single iron conductor.

It is not necessary to manufacture 700 Fe wires and run them in parallel. The iron conductor can be produced more conveniently in the shapes shown below in Figure 2Q35-2, and it will be cheaper than the Cu conductor.

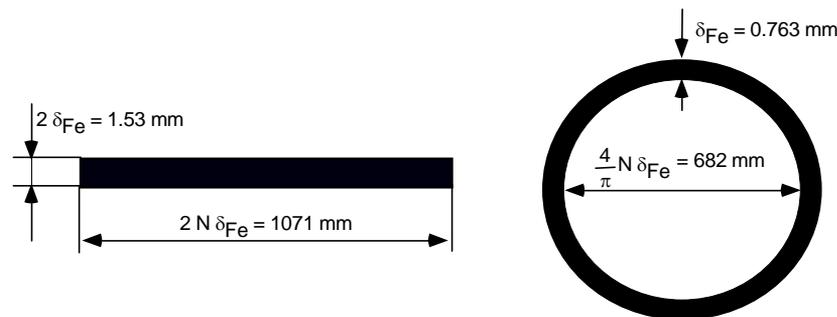

Figure 2Q35-2

But, it will be of impractical size; it will have poor mechanical properties and will be 5 times heavier compared with the single Cu wire. A power grid based on Cu conductors will be much cheaper and much smaller than the one based on Fe conductors.

2.36 Mayadas-Shatzkes thin film resistivity Consider Equation 2.72 for the resistivity of a polycrystalline thin film in terms of β . Consider the expansion of Equation 2.72 around $\beta = 1$. If $\Delta\beta = \beta - 1$, then show that

$$\frac{\rho_{\text{film}}}{\rho_{\text{crystal}}} \approx 1.030 + 1.348\beta \quad \text{Grain boundary scattering in thin films [2.89]}$$

Plot the actual expression for $(\rho_{\text{film}} / \rho_{\text{crystal}})$ vs. β and then Equations 2.73a and 2.89 vs β and compare the three. What would be a range of values for which Equations 2.73 and 2.89 can be used with 3% error? What is your conclusion?

Solution

The Mayadas-Shatzkes equation needs to be differentiated only once to find the linear term in β in the expansion. Consider

$$y = \frac{\rho}{\rho_{\text{crystal}}} = \frac{1}{1 - (3/2)\beta + 3\beta^2 - 3\beta^3 \ln(1 + \beta^{-1})} = \frac{1}{u(\beta)}$$

where $u = 1 - (3/2)\beta + 3\beta^2 - 3\beta^3 \ln(1 + \beta^{-1})$

$$\therefore \frac{dy}{d\beta} = \frac{dy}{du} \frac{du}{d\beta} = \frac{-1}{u^2} \frac{du}{d\beta}$$

Differentiating u with respect to β ,

$$\frac{du}{d\beta} = -(3/2) + 6\beta - 9\beta^2 \ln[(\beta + 1)/\beta] - (3\beta^3) \left[\frac{1}{(1 + \beta^{-1})} \right] \left[\left(\frac{-1}{\beta^2} \right) \right]$$

$$\therefore \frac{du}{d\beta} = -(3/2) + 6\beta - 9\beta^2 \ln(1 + \beta^{-1}) + (3\beta) \left[\frac{1}{(1 + \beta^{-1})} \right]$$

The final result is then

$$\frac{dy}{d\beta} = \frac{(3/2) - 6\beta + 9\beta^2 \ln(1 + \beta^{-1}) - \frac{3\beta}{(1 + \beta^{-1})}}{[1 - (3/2)\beta + 3\beta^2 - 3\beta^3 \ln(1 + \beta^{-1})]^2}$$

and at $\beta = 1$ we have

$$\left[\frac{dy}{d\beta} \right]_{\beta=1} = \frac{(3/2) - 6 + 9 \ln(1 + 1) - \frac{3}{(1 + 1)}}{[1 - (3/2) + 3 - 3 \ln(1 + 1)]^2} = 1.3475$$

and

$$y(1) = \frac{1}{1 - (3/2) + 3 - 3 \ln(1 + 1)} = 2.3778$$

Then, the Taylor expansion around $\beta = 1$ becomes

$$y = y(1) + (\beta - 1) \left[\frac{dy}{d\beta} \right]_{\beta=1} = 2.3778 + (\beta - 1)(1.3475) = 1.0303 + 1.3475\beta$$

Figure 2Q36-1 shows the plots of the actual Mayadas-Shatzkes thin film resistivity (BLACK) and the approximations in Equations 2.73a and 2.90. Equation 2.90 seems to provide a good approximation to the exact expression for β at least from 0.1 to 10

🗨 PLOTS $\rho_{\text{film}} / \rho_{\text{crystal}}$

🗨 BLACK is the actual Mayadas-Shatzkes formula

$$\square y = \frac{1}{1 - \frac{3}{2}\beta + 3\beta^2 - 3\beta^3 \ln(1 + \beta^{-1})}$$

🗨 BLUE is the approximation

$$\square y' = 1 + \frac{3}{2}\beta$$

🗨 RED is the approximation in Equation 2.90

$$\square y'' = 1.3475\beta + 1.0303$$

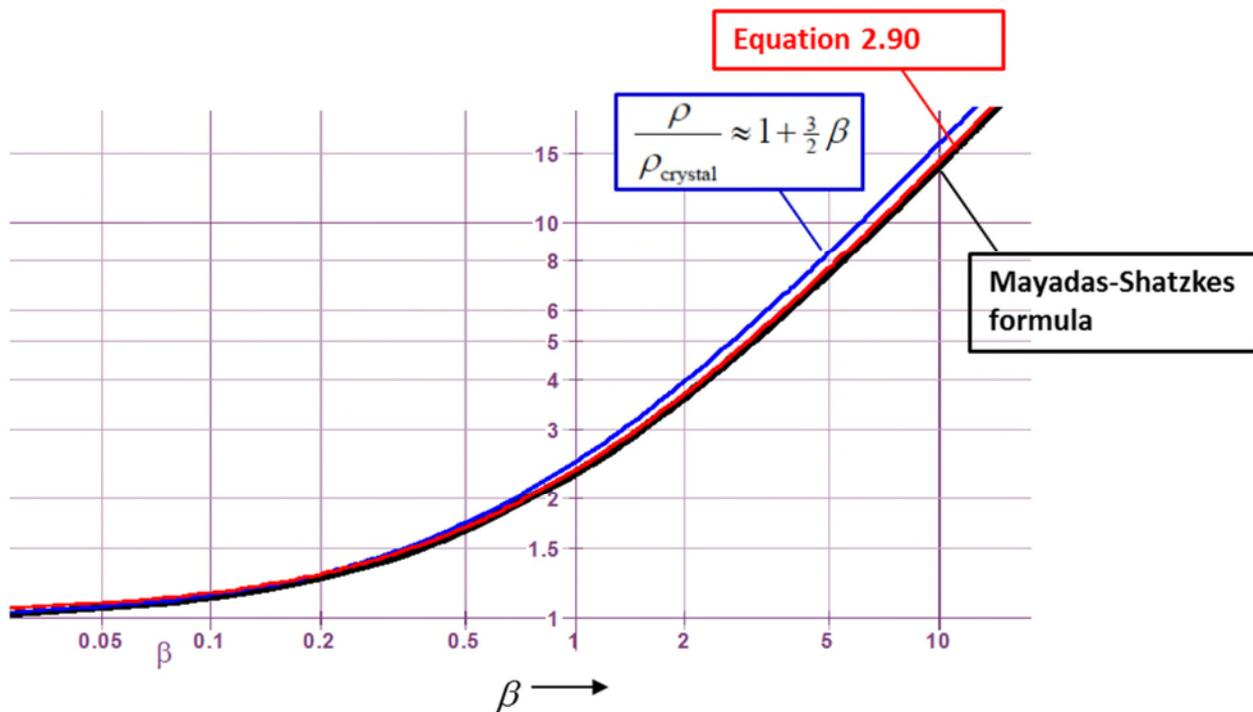

Figure 2Q36-1 Plots of the actual Mayadas-Shatzkes thin film resistivity (BLACK) and the approximations in Equation 2.90 (RED) and 2.73a (BLUE)

we can find the error by using a math software and plotting the error as a function of β as in Figure 2Q36-2. β cannot be bigger than 10 for the errors to remain below 2%. Thus, we need $0 < \beta < 10$

Consider now the error. Define y = Equation 2.72a (actual Mayadas-Shatzkes formula), y' = Equation 2.90 and y'' = Equation 2.73a. Then errors are defined as

🗨 Error as a percentage is defined as

$$\square \text{Error} = \left| \frac{y - y''}{y} \cdot 100 \right|$$

$$\square \text{Error}' = \left| \frac{y - y'}{y} \cdot 100 \right|$$

These errors are plotted in Figure 2Q36-1. Clearly the error in Equation 2.73a shrinks as β gets smaller, as we expect since this equation assumes that β is small. The error in Equation 2.90 remains below 3% at least over for $0.01 < \beta < 100$ and vanishes at $\beta = 1$ as we expect.

Conclusion: We can use Equation 2.90 over $0.01 < \beta < 100$ with error below 3%

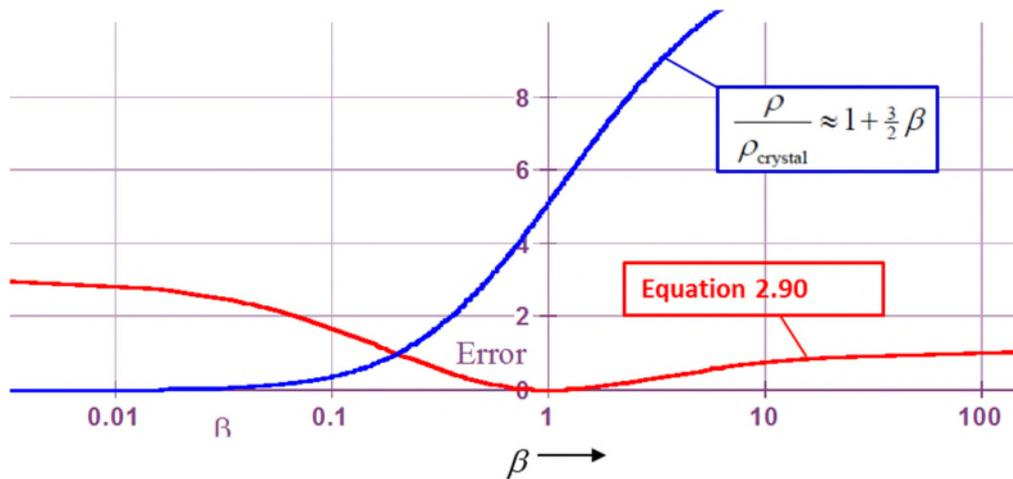

Figure 2Q36-2 Plots of error involved in using the approximation in Equation 2.90 for a range of β values. Top curve has a logarithmic β -axis. Bottom curve is a linear plot. The error remains below 3% for $0.01 < \beta < 100$

Note: The Taylor expansion can also be done by using a symbolic algebra software as shown below using Livemath (formerly Theorist) or by using an online application such as WolframAlpha

2.36 Mayadas-Shatzkes thin film resistivity

Let $x = \beta - 1 = \Delta\beta$

$$\beta = x + 1$$

$$\Delta x = \beta - 1 \quad \text{Isolate}$$

Let $z = \rho_{\text{film}} / \rho_{\text{crystal}}$, so that Mayadas-Shatzkes formula gives

$$z = \frac{1}{1 - \frac{3}{2}\beta + 3\beta^2 - 3\beta^3 \ln(1 + \beta^{-1})}$$

$$\Delta z = \frac{1}{3(x+1)^2 - \frac{3}{2}(x+1) - 3(x+1)^3 \ln\left(\frac{1}{x+1} + 1\right) + 1} \quad \text{Substitute}$$

Carry out Taylor expansion around $x = 0$. This is obtained from $z = z(0) + x[(dz/dx) \text{ at } x = 0]$ and involves only one differentiation of $z = f(x)$

$$\Delta z = 1.3475x + 2.3778 \quad \text{Taylor Series}$$

which is the desired result.

Now, given the above around $\beta = 1$, we can substitute for x as $x = \beta - 1$ to find

$$\frac{\rho_{\text{film}}}{\rho_{\text{crystal}}} = 1.3475x + 2.3778$$

$$\Delta \frac{\rho_{\text{film}}}{\rho_{\text{crystal}}} = 1.3475(\beta - 1) + 2.3778 \quad \text{Substitute}$$

$$\Delta \frac{\rho_{\text{film}}}{\rho_{\text{crystal}}} = 1.3475\beta + 1.0303 \quad \text{Expand}$$

This is Equation 2.90

One can also use the online WolframAlpha from Wolfram (<http://www.wolframalpha.com>) (accessed October 14, 2016)



derivative of $1/(1-(3/2)*x+3*(x)^2-3*((x)^3)*\ln((1+x)/x))$



Web Apps Examples Random

Derivative:

Approximate form

Step-by-step solution

$$\frac{d}{dx} \left(\frac{1}{1 - \frac{3x}{2} + 3x^2 - 3x^3 \log\left(\frac{1+x}{x}\right)} \right) = - \frac{-9x^2 \log\left(\frac{x+1}{x}\right) - \frac{3\left(\frac{1}{x} - \frac{x+1}{x^2}\right)x^4}{x+1} + 6x - \frac{3}{2}}{\left(-3x^3 \log\left(\frac{x+1}{x}\right) + 3x^2 - \frac{3x}{2} + 1\right)^2}$$

$\log(x)$ is the natural logarithm

$$\frac{\partial}{\partial x} \frac{1}{1 - \frac{3}{2}x + 3x^2 - 3x^3} \log\left(\frac{1+x}{x}\right) \text{ where } x = 1$$

Result

$$\frac{12(\log(8) - 2)}{(\log(64) - 5)^2} \approx 1.34746$$

2.37 Polycrystalline copper films Consider the data in Figure 2.38a, which are reproduced below in Table 2.19 in terms of the average grain size (d) and the resistivity of the film. Plot these on an excel graph resistivity Equation 2.72a. You can then modify R to bring the theoretical curve as close as possible to the experimental curve. What is your conclusion?

Table 2.19 Dependence of the resistivity of polycrystalline films of copper on the grain size. Data extracted from S. Riedel *et al.*, *Microelec. Engin.* **33**, 165, 1997.

d (nm)	189	168	139	140	128	107	99.3	59.8	44.3
ρ_{film} (n Ω m)	20.97	21.16	22.21	22.65	22.09	23.39	23.89	27.92	31.20

Solution

Assume that the resistivity of the polycrystalline films is limited by the grain size rather than the actual film thickness. Figure 2Q37-1 and 2Q37-2 show the plots of the experimental thin film resistivity vs. grain size (ρ_{film} vs. d) for the present polycrystalline copper films, using the data from Table 2.19. The dashed lines in both Figure 2Q37-1 and 2Q37-2 are the theoretical Mayadas-Shatzkes equation curves generated from

$$\rho_{\text{film}} = \frac{\rho_{\text{crystal}}}{1 - (3/2)\beta + 3\beta^2 - 3\beta^3 \ln(1 + \beta^{-1})}; \beta = \frac{\lambda}{d} \left(\frac{R}{R-1} \right) \quad (1)$$

where λ = mean free path of electrons in the crystal, taken approximately as 40 nm. In Figure 2Q37-1, $\rho_{\text{crystal}} = 17.3$ n Ω m from Example 2.31 and R set to 0.39 initially (based on Example 2.31). Different R values have been also used in Figure 2Q37-1 to show the effect of R on the theoretical resistivity curve. The values are given in Table 2Q37-1, which is copied from an Excel worksheet with the calculated values.

Clearly $R = 0.39$ is a good choice. We can try other R to see what happens to the fit such as $R = 0.39 \pm 0.5$. These R values generate theoretical curves that are far out from the experimental curve. One can also examine the effect of changing ρ_{crystal} by a little as shown in Figure 2Q37-2 where $\rho_{\text{crystal}} = 17$ n Ω m. The best choice for R seems to be 0.41 in this case as shown in Figure 2Q37-2. The theoretical curves for $R = 0.40$ and 0.42 are slightly off the experimental curve as apparent in Figure 2Q37-2.

In summary, we can fit the data reasonably well using the theoretical Mayadas-Shatzkes equation using $\rho_{\text{crystal}} = 17 - 17.3$ n Ω m and $R = 0.39 - 0.41$.

Table 2Q37-1 Calculations in Excel for Equation 1 using $\lambda = 40$ nm, $\rho_{\text{crystal}} = 17.3$ n Ω m (Example 2.31) and $R = 0.35 - 0.44$.

Parameter =	Lamda	R	Cu resistivity	R	R	R	R
Value =	40	0.4	17.3	0.35	0.35	0.44	0.44
d (nm)	ρ_{film} (n Ω m)	β	Mayadas-Shatzkes	β	Mayadas-Shatzkes	β	Mayadas-Shatzkes
220	Not measured	0.1212	20.344	0.0979	19.769	0.1429	20.875
189	20.97	0.1411	20.832	0.1140	20.166	0.1663	21.447
168	21.16	0.1587	21.262	0.1282	20.516	0.1871	21.952
139	22.21	0.1918	22.068	0.1550	21.170	0.2261	22.896
140	22.65	0.1905	22.034	0.1538	21.143	0.2245	22.857
128	22.09	0.2083	22.467	0.1683	21.495	0.2455	23.364
107	23.39	0.2492	23.453	0.2013	22.297	0.2937	24.521
99.3	23.89	0.2685	23.917	0.2169	22.674	0.3165	25.066
59.8	27.92	0.4459	28.143	0.3602	26.107	0.5256	30.024
44.3	31.2	0.6020	31.823	0.4862	29.095	0.7094	34.346
37	Not measured	0.7207	34.610	0.5821	31.356	0.8494	37.622

Table 2Q37-2 Calculations in Excel for Equation 1 using $\lambda = 40$ nm, $\rho_{\text{crystal}} = 17.3$ n Ω m (Example 2.31) and $R = 0.35 - 0.44$.

Parameter =	Lamda	R	Cu resistivity	R	R	R	R
Value =	40	0.41	17	0.4	0.4	0.42	0.42
d (nm)	ρ_{film} (n Ω m)	β	Mayadas-Shatzkes	β	Mayadas-Shatzkes	β	Mayadas-Shatzkes
220	Not measured	0.1263	20.115	0.1212	19.991	0.1317	20.243
189	20.97	0.1471	20.614	0.1411	20.470	0.1533	20.763
168	21.16	0.1655	21.055	0.1587	20.894	0.1724	21.221
139	22.21	0.2000	21.879	0.1918	21.685	0.2084	22.078
140	22.65	0.1985	21.845	0.1905	21.652	0.2069	22.043
128	22.09	0.2172	22.287	0.2083	22.077	0.2263	22.504
107	23.39	0.2598	23.296	0.2492	23.046	0.2707	23.553
99.3	23.89	0.2799	23.771	0.2685	23.503	0.2917	24.048
59.8	27.92	0.4648	28.094	0.4459	27.654	0.4844	28.548
44.3	31.2	0.6275	31.860	0.6020	31.271	0.6538	32.469
37	Not measured	0.7513	34.713	0.7207	34.010	0.7829	35.440

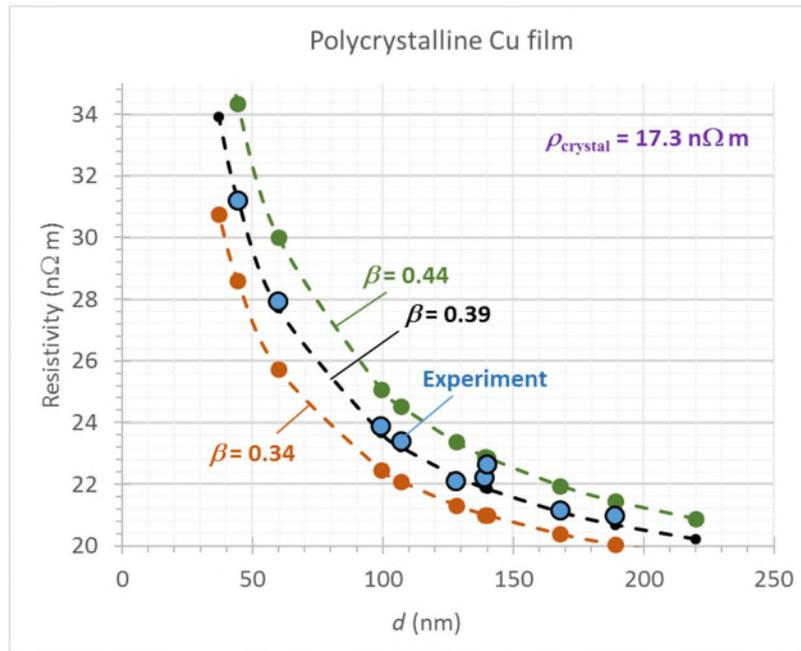

Figure 2Q37-1 Thin film resistivity vs grain size (ρ_{film} vs. d) for polycrystalline copper films, using the data from Table 2Q371-1. The dashed lines are the Mayadas-Shatzkes equation with $\rho_{\text{crystal}} = 17.3 \text{ n}\Omega \text{ m}$ from Example 2.31, and brown $\beta = 0.34$, black $\beta = 0.39$, green $\beta = 0.44$, but other choices can also be plotted.

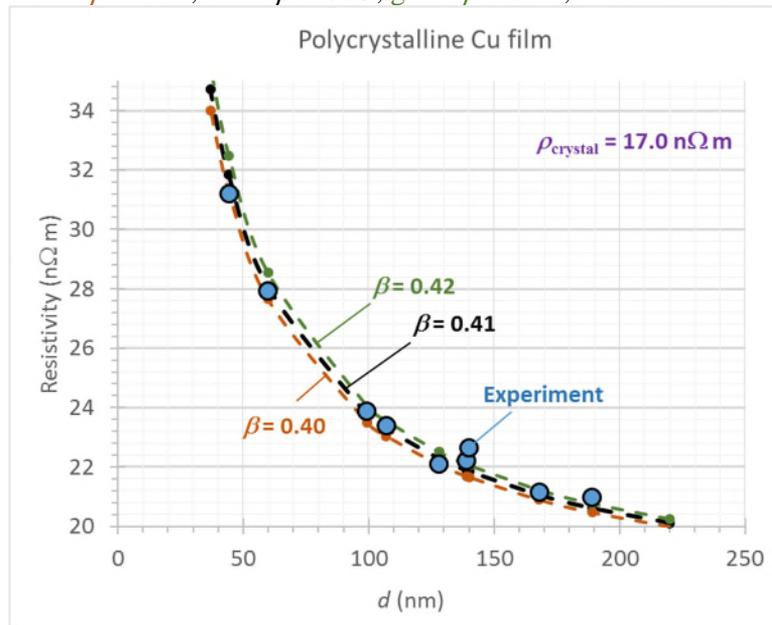

Figure 2Q37-2 Thin film resistivity vs grain size (ρ_{film} vs. d) for polycrystalline copper films, using the data from Table 2Q371-2. The dashed lines are the Mayadas-Shatzkes equation with $\rho_{\text{crystal}} = 17.0 \text{ n}\Omega \text{ m}$, and brown $\beta = 0.40$, black $\beta = 0.41$, green $\beta = 0.42$.

Note: This question also highlight to students that the fitting a multivariable function to experimental data does not necessarily result in a unique set of best fit parameters. The black dashed curves in Figures 2Q37-1 and 2 are both "best fits".

2.38 Thin films

- a. Consider a polycrystalline copper film that has $R = 0.40$. What is the approximate mean grain size d in terms of the mean free path λ in the bulk that would lead to the polycrystalline Cu film having a resistivity that is $1.5\rho_{\text{bulk}}$. If the mean free path in the crystal is about 40 nm at room temperature, what is d ?
- b. What is the thickness D of a copper film in terms of λ in which surface scattering increases the film resistivity to $1.2\rho_{\text{bulk}}$ if the specular scattering fraction p is 0.1?

Solution

a. We can estimate the grain size quite quickly by using the approximation to the Mayadas-Shatzkes equation in Part 1. Part 2 provides an exact calculation by solving the Mayadas-Shatzkes equation. Part 3 uses the approximate equation given in Equation 2.90

1. Large grain size approximation, assumes that $d \gg \lambda$, so that the Mayadas-Shatzkes equation gives the resistivity of polycrystalline sample as

$$\frac{\rho}{\rho_{\text{crystal}}} \approx 1 + (3/2)\beta \quad \text{where,} \quad \beta = \frac{\lambda}{d} \left(\frac{R}{1-R} \right).$$

Using the probability of reflection at a grain boundary $R = 0.40$, in the above formula we have

$$\frac{1.5\rho_{\text{crystal}}}{\rho_{\text{crystal}}} \approx 1 + (3/2) \frac{\lambda}{d} \left(\frac{0.4}{1-0.4} \right)$$

$$\therefore 1.5 = 1 + (1) \frac{\lambda}{d} \quad \text{or} \quad 1.5 - 1 = \frac{\lambda}{d}$$

$$\therefore d = 2\lambda$$

If the mean free path in the crystal is $\lambda = 40$ nm, then the mean grain size is $d = 2(40 \text{ nm}) = \mathbf{80 \text{ nm}}$.

2. Using the exact Mayadas-Shatzkes Equation, we have

 (a) 2. Using the exact form of the Mayadas-Shatzkes Equation

 Let $y = \rho_{\text{film}} / \rho_{\text{crystal}}$. We need to have $y = 1.5$ so we need the β value that makes $y = 1.5$, that is

$$\square 1.5 = \frac{1}{1 - \frac{3}{2}\beta + 3\beta^2 - 3\beta^3 \ln\left(1 + \frac{1}{\beta}\right)}$$

$$\triangle 1.5 \left(-3\beta^3 \ln\left[\frac{1}{\beta} + 1\right] + 3\beta^2 - \frac{3}{2}\beta + 1 \right) = 1 \quad \text{Move Over}$$

$$\triangle 0 = -1.5 \left(-3\beta^3 \ln\left[\frac{1}{\beta} + 1\right] + 3\beta^2 - \frac{3}{2}\beta + 1 \right) + 1 \quad \text{Move Over}$$

 We need to solve the above equation. Let's define zero as

$$\square \text{zero} = -1.5 \left(-3\beta^3 \ln\left[\frac{1}{\beta} + 1\right] + 3\beta^2 - \frac{3}{2}\beta + 1 \right) + 1$$

and then plot "zero" (LHS) against β to find where the curve cross the β -axis as below. The solution is $\beta = 0.353$

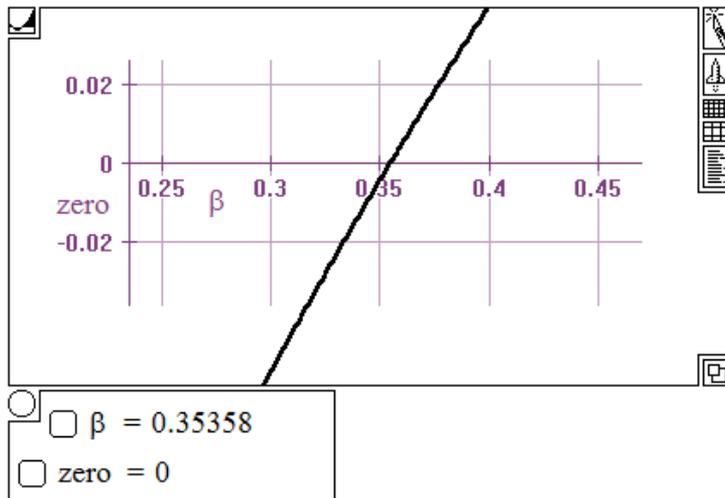

Given $\beta' = 0.353$, $R = 0.4$, $\lambda = 40$ nm, we can find the grain size "dgrain"

$\beta' = 0.35$ $R = 0.4$ $\lambda = 40$ nm

$\beta' = \frac{\lambda}{d_{\text{grain}}} \frac{R}{1 - R}$

$\triangle d_{\text{grain}} = \frac{\lambda R}{\beta' (-R + 1)}$ *Isolate*

$\triangle d_{\text{grain}} = 76.19$ *Calculate* nm

Therefore $d/\lambda = 1.90$ and $d = 76.2$ nm. The estimate for d in Part 1 is about 4.8% bigger than the actual grain size we need

3. Using the approximate expression in Equation 2.90

Given the mean free path of electrons in Cu

$\lambda = 40 \text{ nm}$

Reflection coefficient

$R = 0.4$

Let $y = \rho_{\text{film}} / \rho_{\text{crystal}}$

The approximation in Equation 2.90 to the Mayadas-Shatzkes equation is given by

$y = 1.030 + 1.348 \beta$

Given $y = 1.5$

$1.5 = 1.03 + 1.348 \beta$

$\beta = 0.34866$ *Isolate*

Given β we can find d/λ

$\beta = \frac{\lambda}{d_{\text{grain}}} \frac{R}{1 - R}$

$d_{\text{grain}} = \frac{\lambda R}{(-R + 1)\beta}$ *Isolate*

$d_{\text{grain}} = 76.482$ *Calculate*

or $d = 76.5 \text{ nm}$, which is very close to that calculated from the exact Mayadas-Shatzkes equation.

Note: Equation 2.90 has the advantage that it is based on approximating the Mayadas-Shatzkes Equation around $\beta = 1$, rather than $\beta = 0$.

b. Surface scattering resistivity is given by Equation 2.77 as

$$\frac{\rho}{\rho_{\text{bulk}}} \approx 1 + \frac{3\lambda}{8D}(1 - p) \quad \frac{D}{\lambda} > 0.3$$

Using $p = 0.1$, and $\rho_{\text{film}} = 1.2\rho_{\text{crystal}}$, we have

$$1.2 \frac{\rho_{\text{bulk}}}{\rho_{\text{bulk}}} \approx 1 + \frac{\lambda}{D} \cdot \frac{3}{8} \cdot (1 - 0.1)$$

$$1.2 \approx 1 + 0.3375 \frac{\lambda}{D}$$

Simplifying we have

$$D \approx 1.69 \lambda = 67.5 \text{ nm}$$

Note: Most successful models that account for the observed resistivity of a thin film as a function of thickness invariably involve combining surface scattering not only with grain boundary scattering, but also including other factors, such as the effect of surface roughness on the scattering mechanism. (A good example is H. D. Liu et al, *Thin Solid Films*, **384**, 151-156, 2001.)

2.39 Thin films of Cu Consider the resistivity of three types of Cu thin films are shown in Table 2.20. Three films are one single crystal layer, and two polycrystalline layers with an average grain size

Copyright © McGraw-Hill Education. All rights reserved. No reproduction or distribution without the prior written consent of McGraw-Hill Education.

shown in the table. All have the same thickness $D = 40$ nm. The resistivity measurements have an error bar (representing the scatter) that is roughly $\pm 3\%$. Suppose we write Matthiessen's rule as

$$\rho_{\text{film}} = \rho_{\text{crystal}} + \Delta\rho_{\text{MS}} + \Delta\rho_{\text{SF}} \quad \text{Surface and grain boundary scattering in films [2.90a]}$$

$$\text{or } \rho_{\text{film}}/\rho_{\text{crystal}} \approx 1 + (3/2)\beta + (3/8)(\lambda/D)(1-p) \quad \text{Surface and grain boundary scattering in films [2.90b]}$$

where β is defined in Equation 2.73b, ρ_{crystal} is the bulk resistivity of the Cu crystal and $\Delta\rho_{\text{MS}}$ and $\Delta\rho_{\text{SF}}$ are the contributions to resistivity arising from the scattering of electrons at the grain boundary and surfaces respectively; that is, the Mayadas-Shatzkes and Fuch-Sondheimer contributions respectively. Complete Table 2.20 by taking $\rho_{\text{crystal}} = 17.0$ n Ω m and assuming $p = 0$ and $R = 0.25$. What is your conclusion?

Table 2.20 The resistivity of three types of thin Cu films with the same thickness $D = 40$ nm.

d (nm)	ρ_{film} (n Ω m)	$\Delta\rho_{\text{MS}}$ (n Ω m)	$\Delta\rho_{\text{SF}}$ (n Ω m)	$\rho_{\text{crystal}} + \rho_{\text{MS}} + \rho_{\text{SF}}$	Difference (%)
∞	24.8	0	6.375	23.38	5.7
160	26.8	2.125	6.375	25.50	4.85
40	29.1	8.500	6.375	31.9	9.5

NOTE: Data extracted from J.S. Chawla, *Phys. Rev. B* **84**, 235423, 2011. d is the average grain size.

Solution

Consider the $d = 40$ nm, as an example

$$\Delta\rho_{\text{MS}} = \rho_{\text{crystal}}(3/2)\beta$$

$$\therefore \Delta\rho_{\text{MS}} = \rho_{\text{crystal}}(3/2)\frac{\lambda}{d}\left(\frac{R}{R-1}\right) = (17\text{ n}\Omega\text{ m})(3/2)\frac{40\text{ nm}}{40\text{ nm}}\left(\frac{0.25}{0.25-1}\right) = 8.5\text{ n}\Omega\text{ m}$$

For the surface scattering we have

$$\Delta\rho_{\text{SF}} = \rho_{\text{crystal}}(3/8)\frac{\lambda}{D}(1-p) = (17\text{ n}\Omega\text{ m})(3/8)\frac{40\text{ nm}}{40\text{ nm}}(1-0) = 6.375\text{ n}\Omega\text{ m}$$

Thus, the overall resistivity is

$$\rho_{\text{film}} = \rho_{\text{crystal}} + \Delta\rho_{\text{MS}} + \Delta\rho_{\text{SF}} = 17\text{ n}\Omega\text{ m} + 8.5\text{ n}\Omega\text{ m} + 6.375\text{ n}\Omega\text{ m} = \mathbf{31.88\text{ n}\Omega\text{ m}}$$

which is entered into Table 2.20. The other 2 rows are similarly calculated and entered as can be seen in Table 2.20 above. The excel calculations are summarized in Table 2Q39-1.

For each film, we can calculate the difference between the experimental and calculated value as a percentage as shown in the table; these are 4.9 – 9.5%. The simple combination of grain boundary scattering (small β approximation) and surface scattering works reasonably well in this case.

Table 2Q39-1

Parameter =	Lamda	R	Cu resistivity	p	D (nm)	
Value =	40	0.25	17	0	40	
d (nm)	ρ_{film} (n Ω m)	β	MS	SF	ρ_{total}	Difference (%)
1.00E+06	24.8	0.0000	0.000	6.3750	23.38	5.74
160	26.8	0.0833	2.125	6.3750	25.50	4.85

40	29.1	0.3333	8.500	6.3750	31.88	-9.54
----	------	--------	-------	--------	-------	-------

ADDENDUM

We can try and do better by playing with R , as shown in Tables 2Q39-2. We can reduce the difference for the 40 nm grain-size film by setting $R = 0.20$, but this increases the difference for 160 nm grain-size film.

Parameter =	Lamda	R	Cu resistivity	p	D (nm)	
Value =	40	0.2	17	0	40	
d (nm)	ρ_{film} (n Ω m)	β	MS	SF	ρ_{total}	Difference (%)
1.00E+06	24.8	0.0000	0.000	6.3750	23.38	5.74
160	26.8	0.0625	1.594	6.3750	24.97	6.83
40	29.1	0.2500	6.375	6.3750	29.75	-2.23

2.40 Thin films of single crystal Cu on TiN Thin single crystal films of Cu have been deposited on to a TiN (001) surface grown on a MgO crystal substrate by . Room temperature (25 °C) resistivity measurements *in situ* (in vacuum) give the data in Table 2.21. How would you interpret the data?

Table 2.21 The resistivity of Cu single crystal thin films deposited on TiN (001) surface in situ in vacuum.

D (nm)	830	40.0	13.3	6.20
ρ (n Ω m) (vacuum)	17.1	21.0	29.7	44.4

Data selectively taken from J.S. Chawla *et al.*, *J. Appl. Phys.* **110**, 043714, 2011

Solution

For single crystal thin films, we would only have scattering from the surfaces (ignoring any surface roughness) and we can use

$$\rho_{\text{film}} = \rho_{\text{crystal}} \left[1 + (3/8) \frac{\lambda}{D} (1-p) \right] = \rho_{\text{crystal}} + (3/8) \rho_{\text{crystal}} \lambda (1-p) \left(\frac{1}{D} \right)$$

so that we can plot ρ_{film} vs $1/D$ as in Figure 2Q40-1. We can easily fit a best straight line which is

$$y = 16.84 + 171x$$

$$\therefore \rho_{\text{film}} = 16.84 + 171 \left(\frac{1}{D} \right)$$

Compare with

$$\rho_{\text{film}} = \rho_{\text{crystal}} + (3/8) \rho_{\text{crystal}} \lambda (1-p) \left(\frac{1}{D} \right)$$

Clearly, $\rho_{\text{crystal}} = 16.84$ n Ω m, and

$$\text{Slope} = (3/8) \rho_{\text{crystal}} \lambda (1-p) = 171$$

We can substitute

$$\text{Slope} = (3/8)(16.84)(40)(1-p) = 171$$

$$\therefore p = 0.323$$

Conclusion: The data can be interpreted in a straightforward way by simply assuming thin film surface scattering in which $p = 0.323$

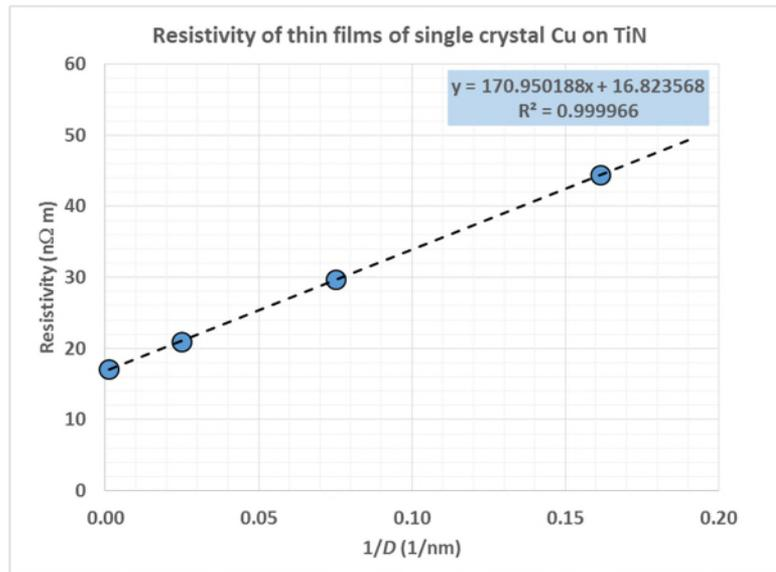

Figure 2Q40-1 The plot of the resistivity of single crystal thin films of copper vs. reciprocal film thickness, ρ_{film} vs $1/D$ (Data from Table 2.21)

2.41 Thin films of W Thin single crystal films of W have been grown epitaxial on sapphire (Al_2O_3) substrates. The resistivity of a 187 nm thick film is 64 nΩ m, which can be taken as the bulk resistivity. The W film with a thickness 19.9 nm has a resistivity of 86 nΩ m. If the mean free path λ in the bulk is 19.1 nm, what is the average p ?

Solution

The ratio of the film resistivity to that of the crystal is

$$\frac{\rho_{\text{film}}}{\rho_{\text{crystal}}} = 1 + (3/8) \frac{\lambda}{D} (1-p)$$

$$\therefore \frac{86 \text{ n}\Omega\text{m}}{64 \text{ n}\Omega\text{m}} = 1 + (3/8) \left(\frac{19.1 \text{ nm}}{19.9 \text{ nm}} \right) (1-p)$$

$$\therefore 1.3438 = 1 + (3/8)(0.960)(1-p)$$

and solving for p

$$p = 0.045$$

Note: Data on annealed samples at 293 K from Table II in D. Choi *et al.*, "Electron mean free path of tungsten and the electrical resistivity of epitaxial (110) tungsten films", Phys. Rev. B, 86, 045432 (2012).

2.42 Thin films of Cu on Si (100) surface Different thickness polycrystalline Cu films have been deposited on the (100) surface of a Si crystal. Their resistivities have been measured as summarized in Table 2.22. For these films, the average grain size d has been shown to be related to the film thickness D by $d \approx D/2.3$. Use Matthiessen's rule to combine Fuch-Sondheimer and Mayadas-Shatzkes equations as in Equation 2.90b and plot ρ against $1/D$ and also ρ against D as a log-log plot on Excel or a similar application. Plot the expected ρ in these graphs from Equation 2.90b by taking $p = 0$, $\lambda = 40$ nm and $R = 0.25$. Try a slightly greater and slightly lower R values (*e.g.* 0.20 and 0.30) to see how the predicted curve changes with respect to the data. What is your conclusion?

Table 2.22 The resistivity of thin polycrystalline Cu films on the Si (100) surface.

D (nm)	407	222	170	120	101	85.4	68.5	51.2	34.1	17.2	8.59
ρ (nΩ m)	19.8	20.8	20.0	22.1	23.5	27.9	30.7	32.2	50.4	70.5	126

NOTE: J.W. Lim and M. Isshiki, *J. Appl. Phys.* **99** 094909, 2006

Solution

We can combine grain boundary and surface scattering through Matthiessen's rule as follows

$$\rho_{\text{film}} = \rho_{\text{crystal}} + \Delta\rho_{\text{MS}} + \Delta\rho_{\text{SF}}$$

$$\therefore \rho_{\text{film}} = \rho_{\text{crystal}} + \rho_{\text{crystal}} \left[(3/8) \frac{\lambda}{D} (1-p) \right] + \rho_{\text{crystal}} [f_{\text{MS}}(\beta) - 1] \quad (1)$$

where

$$f(\beta) = \frac{1}{1 - (3/2)\beta + 3\beta^2 - 3\beta^3 \ln(1 + \beta^{-1})}; \quad \beta = \left(\frac{\lambda}{d} \right) \left(\frac{R}{1-R} \right) \quad (2)$$

It is important to understand that with just grain boundary scattering we would have

$$\rho_{\text{film}} = \rho_{\text{crystal}} f_{\text{MS}}(\beta)$$

so that

$$\Delta\rho_{\text{MS}} = \rho_{\text{crystal}} f_{\text{MS}}(\beta) - \rho_{\text{crystal}} = \rho_{\text{crystal}} [f_{\text{MS}}(\beta) - 1]$$

Although only the film thickness D is given, experimentally the average grain size $d = D/2.3$. Given $\rho_{\text{crystal}} = 17$ n Ω m and $\lambda = 40$ nm, we can choose $p = 0$ and say $R = 0.25$, and then calculate β for each film thickness D and hence the overall resistivity of the film by using Equation (1) as shown in Table 2Q42-1. We can then increase R to 0.3 and then decrease it to 0.2; all can be done conveniently on Excel.

Table 2Q42-1 Table of calculations used in generating Figure 2Q42-1. Note: $\rho_{\text{crystal}} = 17$ n Ω m, $\lambda = 40$ nm. For the first curve fit, black in Figure 2Q42-1, $p = 0$ and $R = 0.25$

D	$d = D/2.3$	ρ_{film} (Experimental)	β	$\Delta\rho_{\text{MS}} / \rho_{\text{crystal}}$	$\Delta\rho_{\text{SF}} / \rho_{\text{crystal}}$	ρ_{film} in Eq. (1)
-----	-------------	-------------------------------------	---------	--	--	---------------------------------

nm	nm	nΩ m				
407	176.96	19.8	0.0753	0.110	0.037	19.50
222	96.52	20.8	0.1381	0.200	0.068	21.55
170	73.91	20	0.1804	0.260	0.088	22.91
120	52.17	22.1	0.2556	0.364	0.125	25.32
101	43.91	23.5	0.3036	0.431	0.149	26.85
85.4	37.13	27.9	0.3591	0.508	0.176	28.61
68.5	29.78	30.7	0.4477	0.629	0.219	31.42
51.2	22.26	32.2	0.5990	0.835	0.293	36.18
34.1	14.83	50.4	0.8993	1.242	0.440	45.59
17.2	7.48	70.5	1.7829	2.429	0.872	73.12
8.59	3.73	126	3.5700	4.818	1.746	128.60

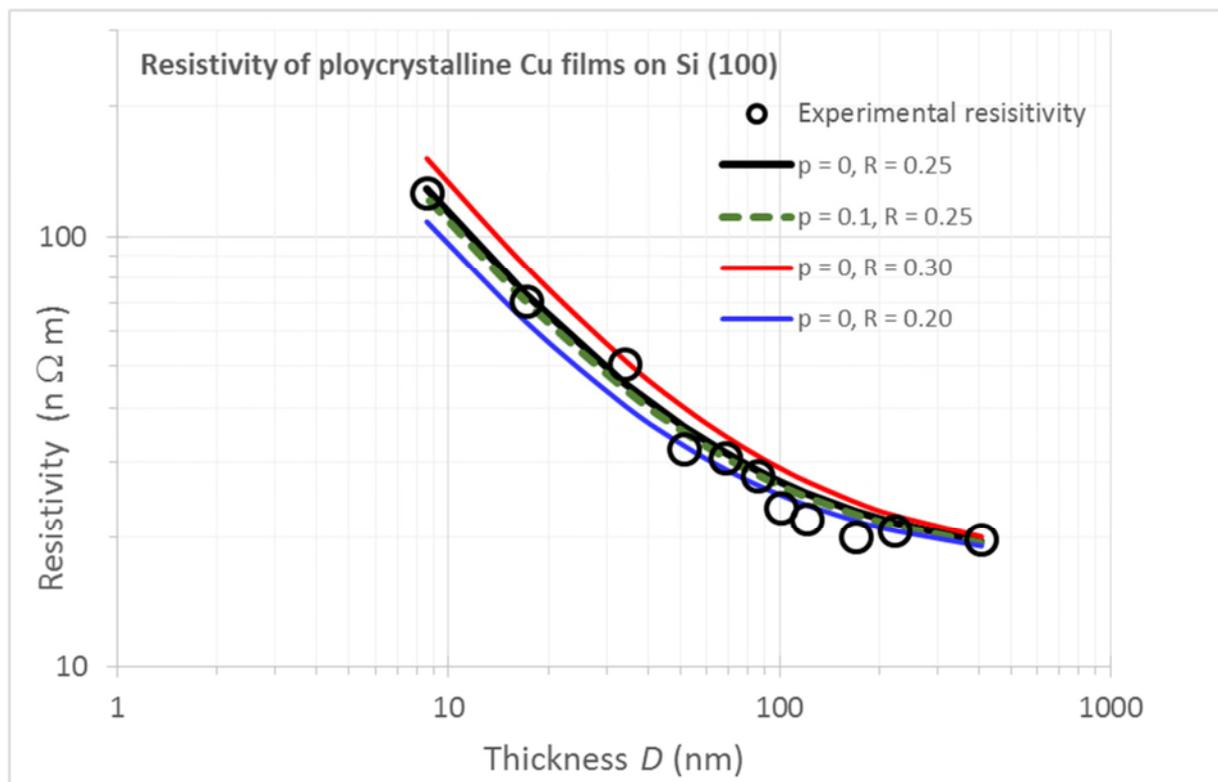

Figure 2Q42 The plot of experimental resistivity vs. film thickness on a log-log scale (large black circles). Equation 1 was used to calculate the film resistivity by taking $\rho_{\text{crystal}} = 17 \text{ n}\Omega \text{ m}$ and $\lambda = 40 \text{ nm}$. The black curve is a particular theoretical fit in which $p = 0$ and $R = 0.25$. Red is $R = 0.30$ and blue is $R = 0.20$. Both curves are away from the experimental points.

Note: The data extracted from: J.W. Lim and M. Isshiki, "Electrical resistivity of Cu films deposited by ion beam deposition: Effects of grain size, impurities, and morphological defect", J. Appl. Phys., 99, 094909 (2006). Their d is the film thickness and D is the grain size.

2.43 Interconnects Consider a CMOS chip in which the interconnects are copper with a pitch P of 500 nm, interconnect thickness T of 400 nm, aspect ratio 1.4, and $H = X$. The dielectric is FSG with $\epsilon_r = 3.6$. Consider two cases, $L = 1 \text{ mm}$ and $L = 10 \text{ mm}$, and calculate the overall effective interconnect capacitance C_{eff} and the RC delay time. Suppose that Al, which is normally Al with about 4 wt.% Cu in

the microelectronics industry with a resistivity $31 \text{ n}\Omega \text{ m}$, is used as the interconnect. What is the corresponding RC delay time?

Solution

The effective capacitance in multilevel interconnect structure is given by Equation 2.61

$$C_{\text{eff}} = 2\varepsilon_0\varepsilon_r L \left(\frac{T}{X} + \frac{W}{H} \right)$$

Aspect ratio is defined as $A_R = \frac{T}{W}$,

or
$$W = \frac{T}{A_R} = \frac{400 \text{ nm}}{1.4} = \mathbf{285.71 \text{ nm.}}$$

The interconnect separation X is

$$X = P - W = 500 \text{ nm} - 285.71 \text{ nm} = \mathbf{214.29 \text{ nm.}}$$

Further $H = X = \mathbf{214.29 \text{ nm.}}$

Therefore the effective capacitance of the interconnect is

For $L = 1 \text{ mm}$

$$C_{\text{eff}} = 2(8.8542 \times 10^{-12} \text{ F m}^{-1})(3.6)(1 \times 10^{-3} \text{ m}) \left(\frac{400 \text{ nm}}{214.29 \text{ nm}} + \frac{285.29 \text{ nm}}{214.29 \text{ nm}} \right)$$

$$= \mathbf{0.204 \times 10^{-12} \text{ F}} \text{ or } \mathbf{0.20 \text{ pF.}}$$

For $L = 10 \text{ mm}$, since C_{eff} is proportional to L ,

$$C_{\text{eff}} = 10 \times 0.204 \text{ pF} = \mathbf{2.04 \text{ pF}}$$

Therefore for Cu, the RC delay time for $L = 1 \text{ mm}$ is

$$RC = 2\varepsilon_0\varepsilon_r \rho \left(\frac{L^2}{TW} \right) \left(\frac{T}{X} + \frac{W}{H} \right)$$

$$RC = 2(8.8542 \times 10^{-12} \text{ F m}^{-1})(3.6)(17 \times 10^{-9} \Omega \text{ m}) \frac{(1 \times 10^{-3} \text{ m})^2}{(400 \times 10^{-9} \text{ m})(285.71 \times 10^{-9} \text{ m})}$$

$$\therefore \times \left(\frac{400 \times 10^{-9} \text{ m}}{214.29 \times 10^{-9} \text{ m}} + \frac{285.29 \times 10^{-9} \text{ m}}{214.29 \times 10^{-9} \text{ m}} \right)$$

$$\therefore RC = 3.05 \times 10^{-11} \text{ s} \text{ or } \mathbf{30.5 \text{ ps}}$$

The RC delay time is proportional to L^2 , so that for $L = 10 \text{ mm}$ is

$$= (3.05 \times 10^{-9} \text{ s})(10 \text{ mm} / 1 \text{ mm})^2 = \mathbf{3.05 \text{ ns}}$$

Given that for Al $\rho = 31 \text{ n}\Omega \text{ m}$, the RC time constant for $L = 1 \text{ mm}$ is

$$RC = 2(8.8542 \times 10^{-12} \text{ F m}^{-1})(3.6)(31 \times 10^{-9} \Omega \text{ m}) \frac{(1 \times 10^{-3} \text{ m})^2}{(400 \times 10^{-9} \text{ m})(285.71 \times 10^{-9} \text{ m})} \\ \times \left(\frac{400 \times 10^{-9} \text{ m}}{214.29 \times 10^{-9} \text{ m}} + \frac{285.29 \times 10^{-9} \text{ m}}{214.29 \times 10^{-9} \text{ m}} \right)$$

$$\therefore RC = 5.53 \times 10^{-11} \text{ s or } \mathbf{55.3 \text{ ps}}$$

The RC delay time is proportional to L^2 , so that for $L = 10 \text{ mm}$ is

$$= (55.3 \text{ ps})(10 \text{ mm} / 1 \text{ mm})^2 = \mathbf{5,530 \text{ ps} = 5.53 \text{ ns}}$$

***2.44 Thin 50 nm interconnects** Equation 2.77 is for conduction in a thin film of thickness D and assumes scattering from two surfaces, which that the increase in the resistivity

$\Delta\rho_2 = \rho_{\text{bulk}} \frac{3}{8} (\lambda/D)(1-p)$. An interconnect line in an IC is not quite a thin film and has four surfaces (interfaces), because the thickness T of the conductor is comparable to the width W . If we assume $T = W$, we can very roughly take $\Delta\rho_4 \approx \Delta\rho_2 + \Delta\rho_2 \approx \rho_{\text{bulk}} \frac{3}{4} (\lambda/D)(1-p)$ in which $D = T$. (The exact

expression is more complicated, but the latter will suffice for this problem.) In addition there will be a contribution from grain boundary scattering so that we need to use Equation 2.90a. For simplicity assume $T \approx W \approx X \approx H \approx 50 \text{ nm}$, $\lambda = 40 \text{ nm}$, $p = 0$ and $\epsilon_r = 3.6$. If the mean grain size d is roughly 30 nm and $R = 0.4$, estimate the resistivity of the interconnect and hence the RC delay for a 0.5 mm interconnect.

Solution

In thin films, in addition to the bulk resistivity, we take into account the resistivity due to scattering from the surfaces and resistivity due to scattering from grain boundaries. As described in the problem statement, the resistivity due to surface scattering from four surfaces in an interconnect can roughly be taken into account as

$$\rho_{\text{surface}} = \rho_{\text{bulk}} \frac{3}{4} \frac{\lambda}{D} (1-p)$$

In addition to the surface scattering, there will be resistivity due to grain boundary scattering as well, which is approximately given by

$$\rho_{\text{grain}} \approx \rho_{\text{bulk}} (3/2) \frac{\lambda}{d} \left(\frac{R}{1-R} \right)$$

The effective resistivity of the interconnect is then

$$\rho = \rho_{\text{bulk}} + \rho_{\text{surface}} + \rho_{\text{grain}}$$

$$\therefore \rho_{\text{film}} = \rho_{\text{bulk}} + \rho_{\text{bulk}} \frac{3}{4} \frac{\lambda}{D} (1-p) + \rho_{\text{bulk}} (3/2) \frac{\lambda}{d} \left(\frac{R}{1-R} \right)$$

Taking the bulk resistivity of Cu as $17 \text{ n}\Omega \text{ m}$, we have

$$\rho = 17 \text{ n}\Omega\text{m} + (17 \text{ n}\Omega\text{m}) \frac{3 (40 \text{ nm})}{4 (50 \text{ nm})} (1-0) + (17 \text{ n}\Omega\text{m}) \frac{3 (40 \text{ nm})}{2 (30 \text{ nm})} \left(\frac{0.40}{1-0.40} \right) = \mathbf{49.9 \text{ n}\Omega\text{ m}}$$

The RC time constant is given by

$$RC = 2\varepsilon_0\varepsilon_r\rho \left(\frac{L^2}{TW} \right) \left(\frac{T}{X} + \frac{W}{H} \right)$$

Therefore for Cu, the RC delay time for $L = 500 \text{ }\mu\text{m}$ is

$$\begin{aligned} RC &= 2(8.8542 \times 10^{-12} \text{ F m}^{-1})(3.6)(49.9 \times 10^{-9} \text{ }\Omega\text{ m}) \frac{(500 \times 10^{-6} \text{ m})^2}{(50 \times 10^{-9} \text{ m})(50 \times 10^{-9} \text{ m})} \left(\frac{50 \text{ nm}}{50 \text{ nm}} + \frac{50 \text{ nm}}{50 \text{ nm}} \right) \\ &= \mathbf{6.36 \times 10^{-10} \text{ s or } 0.64 \text{ ns}} \end{aligned}$$

Note that the calculations can be conveniently done by using the online math software by Wolfram. Using WolframAlpha for the RHS calculation,

$$2 \times 8.8542 \times 10^{-12} \times 3.6 \times 49.9 \times 10^{-9} \times \frac{(500 \times 10^{-6})^2 \left(\frac{50}{50} + \frac{50}{50} \right)}{50 \times 10^{-9} \times 50 \times 10^{-9}}$$

Result

$$6.362273952 \times 10^{-10}$$

Solution in Livemath (formerly Theorist)

🗨️ **2Q44 Thin 50 nm interconnects**

🗨️ Bulk resistivity is the Cu crystal resistivity, which is

$\rho_{\text{bulk}} = 17 \text{ n}\Omega \text{ m}$

🗨️ Mean free path of electrons is

$\lambda = 40 \text{ nm}$

🗨️ Interconnect dimension, equivalent to the film thickness D

$D = 50$

🗨️ Grain to grain reflectance is R

$R = 0.4$

🗨️ Reflection secularity parameter is p

$p = 0$

🗨️ Mean grain size is the average grain diameter d_{grain},

$d_{\text{grain}} = 30 \text{ nm}$

🗨️ Resistance increase $\Delta\rho_{\text{surf}}$ due to scattering from the surfaces (4 surfaces) is

$\Delta\rho_{\text{surf}} = \rho_{\text{bulk}} \cdot \frac{3}{4} \frac{\lambda}{D} (1 - p)$

🔺 $\Delta\rho_{\text{surf}} = 10.2 \text{ Calculate } \text{n}\Omega \text{ m}$

🗨️ Resistance increase $\Delta\rho_{\text{grain}}$ due to scattering from the grain boundaries is

$\Delta\rho_{\text{grain}} = \rho_{\text{bulk}} \cdot \frac{3}{2} \frac{\lambda}{d_{\text{grain}}} \frac{1}{R^{-1} - 1}$

🔺 $\Delta\rho_{\text{grain}} = 22.667 \text{ Calculate } \text{n}\Omega \text{ m}$

🗨️ The total film (interconnect) resistivity ρ_{film} is now the sum, due to Matthiessen's rule

$\rho_{\text{film}} = \rho_{\text{bulk}} + \Delta\rho_{\text{surf}} + \Delta\rho_{\text{grain}}$

🔺 $\rho_{\text{film}} = 49.867 \text{ Calculate } \text{n}\Omega \text{ m}$

🗨️ This is in n Ω m. We need to use in Ω m below by multiplying it with 1E-9

☞ Interconnect dimensions and geometry of interconnects are all given. All are 50 nm

$$\square T = 5 \times 10^{-8} \quad \square W = 5 \times 10^{-8} \quad \square X = 5 \times 10^{-8} \quad \square H = 5 \times 10^{-8} \quad \text{☞ m}$$

☞ Dielectric between the interconnects has an ϵ_r of 3.6

$$\square \epsilon_r = 3.6$$

☞ The interconnect length is L , given as 500 μm

$$\square L = 0.0005 \quad \text{☞ m}$$

☞ The RC lifetime is

$$\square \tau = 2 \epsilon_0 \epsilon_r (\rho_{\text{film}} \cdot 1 \times 10^{-9}) \frac{L^2}{T W} \left(\frac{T}{X} + \frac{W}{H} \right)$$

$$\triangle \tau = 2 \epsilon_0 \epsilon_r (\rho_{\text{film}} \cdot 1 \times 10^{-9}) \left(\frac{L^2}{H T} + \frac{L^2}{W X} \right) \quad \text{Expand}$$

$$\triangle \tau = 6.358 \times 10^{-10} \quad \text{Calculate} \quad \text{☞ s}$$

2.45 Electromigration Although electromigration-induced failure in Cu metallization is less severe than in Al metallization, it can still lead to interconnect failure depending on current densities and the operating temperature. In a set of experiments carried out on electroplated Cu metallization lines, failure of the Cu interconnects have been examined under accelerated tests (at elevated temperatures). The mean lifetime t_{50} (time for 50 percent of the lines to break) have been measured as a function of current density J and temperature T at a given current density. The results are summarized in Table 2.23.

- Plot semi-logarithmically t_{50} versus $1/T$ (T in Kelvins) for the first three interconnects. Al(Cu) and Cu ($1.3 \times 0.7 \mu\text{m}^2$) have single activation energies E_A . Calculate E_A for these interconnects. Cu ($1.3 \times 0.7 \mu\text{m}^2$) exhibits different activation energies for the high- and low-temperature regions. Estimate these E_A .
- Plot on a log-log plot t_{50} versus J at 370 °C. Show that at low J , $n \approx 1.1$ and at high J , $n \approx 1.8$.

Table 2.23 Results of electromigration failure experiments on various Al and Cu interconnects

Al(Cu) [$J = 25 \text{ mA}/\mu\text{m}^2$, $A = 0.35 \times 0.2 (\mu\text{m})^2$]		Cu [$J = 25 \text{ mA}/\mu\text{m}^2$, $A = 0.24 \times 0.28 (\mu\text{m})^2$]		Cu [$J = 25 \text{ mA}/\mu\text{m}^2$, $A = 1.3 \times 0.7 (\mu\text{m})^2$]		Cu ($T = 370 \text{ }^\circ\text{C}$)	
T ($^\circ\text{C}$)	t_{50} (hr)	T ($^\circ\text{C}$)	t_{50} (hr)	T ($^\circ\text{C}$)	t_{50} (hr)	$J \text{ mA } \mu\text{m}^{-2}$	t_{50} (hr)
365	0.11	397	2.87	395	40.3	3.54	131.5
300	0.98	354	12.8	360	196	11.7	25.2
259	5.73	315	70.53	314	825	24.8	14.9
233	15.7	269	180	285	2098	49.2	4.28
		232	899			74.1	2.29
						140	0.69

Solution

- The mean time to 50 percent failure is calculated using Black's equation given by Equation 2.84 as

$$t_{\text{MTF}} = A_B J^{-n} \exp\left(\frac{E_A}{kT}\right)$$

Figure 2Q45-1 shows a semilogarithmic plot of t_{50} versus reciprocal temperature ($1/T$) for Al(Cu). The straight line on this plot implies an exponential behavior with $1/T$. According to Figure 2Q45-1, the best exponential fit is

$$t_{50} = (1.79 \times 10^{-6}) \exp(1.227 \times 10^4 / T)$$

According to Black's Equation,

$$t_{\text{MTF}} = A_B J^{-n} \exp\left(\frac{E_A}{kT}\right)$$

the slope of $\ln(t_{50})$ vs $1/T$ in Figure 2Q45-1 is

$$\frac{E_A}{k} = 1.277 \times 10^4 \text{ K}$$

that is, $E_A = (12770 \text{ K}) (8.617 \times 10^{-5} \text{ eV K}^{-1}) = \mathbf{1.10 \text{ eV}}$.

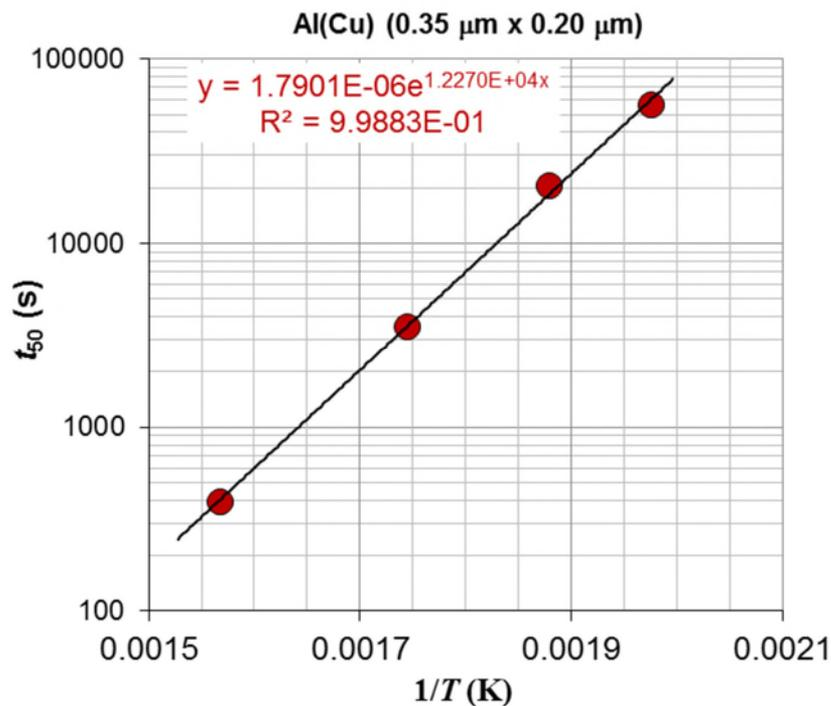

Figure 2Q45-1: Mean time to 50 percent failure (t_{50}) vs. $1/T$ for Al(Cu), 0.35×0.2 (μm)²

Similarly, the semilogarithmic plot of t_{50} vs. reciprocal temperature ($1/T$) plot for Cu ($A = 0.24 \times 0.28$ (μm)²) is shown in Figure 2Q45-2. From the plot we have

$$\frac{E_A}{k} = 1.1419 \times 10^4 \text{ K}$$

or $E_A = (11,419 \text{ K}) (8.617 \times 10^{-5} \text{ eV K}^{-1}) = 0.9840 \text{ eV}$ or **0.98 eV**

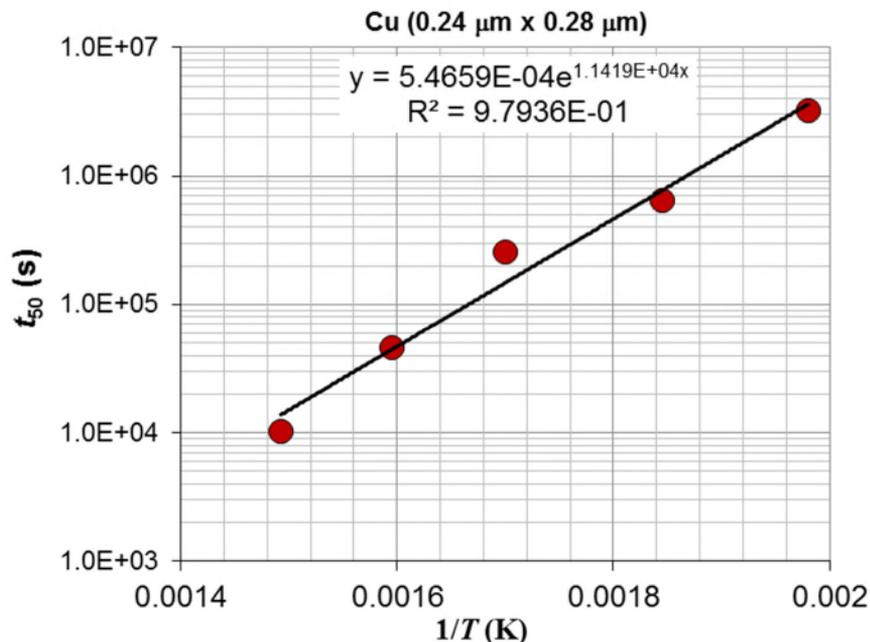

Figure 2Q45-2: Mean time to 50 percent failure (t_{50}) vs. $1/T$ for Cu [$0.24 \times 0.28 (\mu\text{m})^2$]

Comment: In both cases the activation energy E_A is about 1 eV, close to the activation energy for vacancy formation. Vacancies assist atomic electromigration.

The plot for Cu [$A = 1.3 \times 0.70 (\mu\text{m})^2$] is shown in Figure 2Q45-3. We can identify two thermally activated regions.

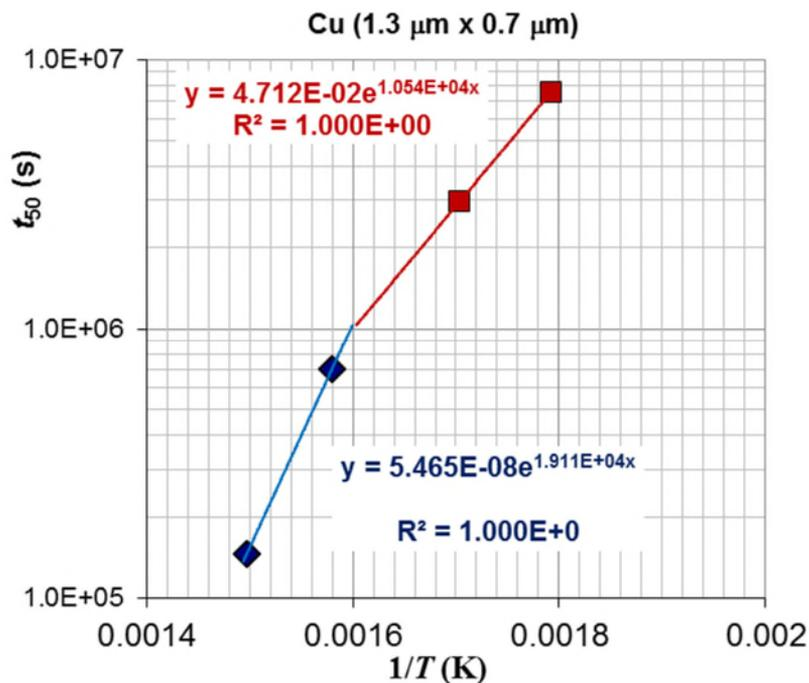

Figure 2Q45-3: Mean time to 50 percent failure (t_{50}) vs. $1/T$ for Cu [$A = 1.3 \times 0.70$ (μm^2)]

The activation energies at high and low temperatures for this case are different.

From Figure 2Q45-3

At low temperatures

$$E_A/k = 1.054 \times 10^4 \text{ K} \therefore E_A = (1.054 \times 10^4 \text{ K})(8.617 \times 10^{-5} \text{ eV K}^{-1}) = 0.9084 \text{ eV or } \mathbf{0.91 \text{ eV}}$$

At high temperatures

$$E_A/k = 1.911 \times 10^4 \text{ K} \therefore E_A = (1.911 \times 10^4 \text{ K})(8.617 \times 10^{-5} \text{ eV K}^{-1}) = 1.647 \text{ eV or } \mathbf{1.65 \text{ eV}}$$

b. A log-log plot of current density J mA/ μm^2 against mean time to 50% failure t_{50} is shown in Figure 2Q45-4

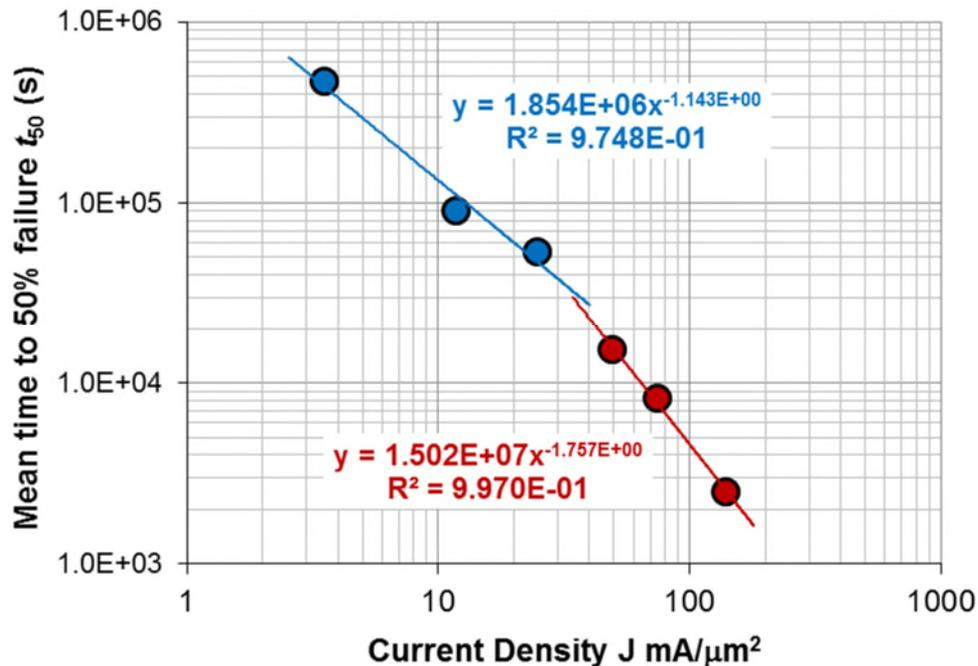
**Figure 2Q45-4:** Log-Log plot of t_{50} vs. J at $T = 370$ °C

The equation for the best fit line are mentioned next to the plot. It is evident from the equations that at low current densities, J^{-n} has n value that is roughly $n \approx 1.14$ or 1.1, and at high temperatures $n \approx 1.76$ or 1.8

Taking natural logarithm \ln of both sides of Black's equation

$$\ln(t_{\text{MTF}}) = \ln\left(A_B J^{-n} \exp\left(\frac{E_A}{kT}\right)\right)$$

$$\therefore \ln(t_{\text{MTF}}) = \ln A_B + \ln J^{-n} + \frac{E_A}{kT}$$

so that at a given temperature

$$\ln(t_{\text{MTF}}) = -n \ln J + \left(\ln A_B + \frac{E_A}{kT} \right)$$

which shows that the slope of t_{50} vs. J on a log-log plot is $-n$

"No one believes in the experimental data except the person who took the measurements; everyone believes in the theory except the person who formulated it."

Anonymous. A humorous adage in Materials Science