

## CHAPTER 2--ALKANES AND CYCLOALKANES

Student: \_\_\_\_\_

1. Approximately how long is a C-C single bond of an alkane?
  - A. 111 pm
  - B. 134 pm
  - C. 142 pm
  - D. 153 pm
2. What is the approximate C-C-C bond angle in propane?
  - A. 180°
  - B. 120°
  - C. 109°
  - D. 90°
3. What is the name of the linear hydrocarbon with the molecular formula  $C_7H_{16}$ ?
  - A. hexane
  - B. heptane
  - C. decane
  - D. undecane
4. What is the name of the linear hydrocarbon with the molecular formula  $C_{11}H_{24}$ ?
  - A. heptane
  - B. decane
  - C. undecane
  - D. eicosane
5. How many hydrogen atoms are there in nonane, the linear hydrocarbon with nine carbon atoms?
  - A. 16
  - B. 18
  - C. 20
  - D. 22
6. How many hydrogen atoms are there in dodecane, the linear hydrocarbon with twelve carbon atoms?
  - A. 12
  - B. 20
  - C. 24
  - D. 26

7. How many constitutional isomers are there with the molecular formula  $C_4H_{10}$ ?
- A. 2  
B. 3  
C. 4  
D. 5
8. How many constitutional isomers are there with the molecular formula  $C_5H_{12}$ ?
- A. 2  
B. 3  
C. 4  
D. 5
9. How many constitutional isomers are there with the molecular formula  $C_6H_{14}$ ?
- A. 3  
B. 4  
C. 5  
D. 8

10. What is the IUPAC name of the following compound?

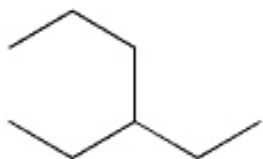

- A. 3-propylpentane  
B. 1,1-diethylpropane  
C. 3-ethylhexane  
D. isooctane
11. What is the IUPAC name of the following compound?

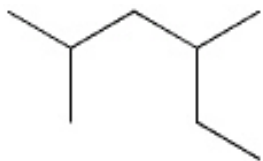

- A. 2-ethyl-4-methylpentane  
B. 2,4-dimethylhexane  
C. 3,5-dimethylhexane  
D. 1,1,3-trimethylpentane

12. What is the IUPAC name of the following compound?

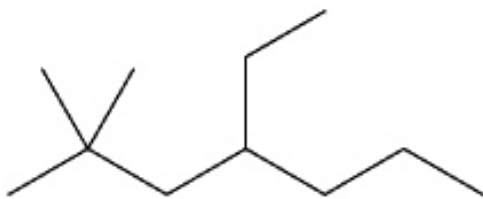

- A. 2,2-dimethyl-4-ethylheptane
- B. 4-ethyl-2,2-dimethyl-heptane
- C. 6,6-dimethyl-4-ethylheptane
- D. 4-ethyl-6,6-dimethyl-heptane

13. What is the IUPAC name of the following compound?

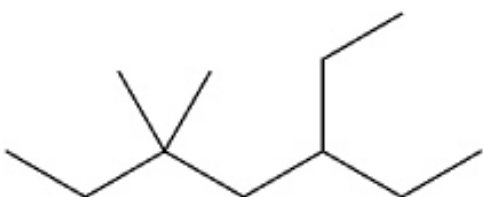

- A. 5,5-dimethyl-3-ethylheptane
- B. 5-ethyl-3,3-dimethyl-heptane
- C. 3,3-dimethyl-5-ethylheptane
- D. 3-ethyl-5,5-dimethyl-heptane

14. What is the IUPAC name of the following compound?

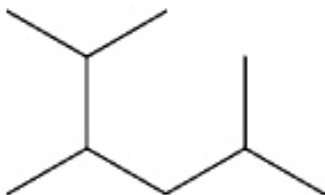

- A. 2-isopropyl-5-methylpentane
- B. 5-isopropyl-2-methylpentane
- C. 2,3,5-trimethylhexane
- D. 1,2-diisopropylpropane

15. What is the IUPAC name of the following compound?

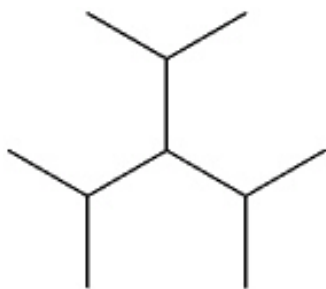

- A. 2,4-dimethyl-3-isopropyl-pentane  
B. 3-isopropyl-1,5-dimethylpentane  
C. 3-isopropyl-2,4-dimethylpentane  
D. triisopropylmethane
16. Which of the following compounds has 1°, 2°, 3° and 4° carbon atoms?
- A. hexane  
B. 2-methylhexane  
C. 2,2-dimethylhexane  
D. 2,2,3-trimethylhexane
17. Which of the following compounds has only 1° and 3° carbon atoms?
- A. hexane  
B. 2-methylpentane  
C. 3-methylpentane  
D. 2,3-dimethylbutane
18. What is the correct assignment of common names for the following molecules?

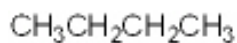

*i*

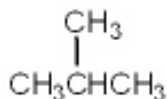

*ii*

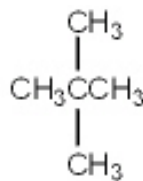

*iii*

- A. *i* = butane; *ii* = neopentane; *iii* = isopentane  
B. *i* = neobutane; *ii* = isobutane; *iii* = pentane  
C. *i* = butane; *ii* = isobutane; *iii* = isopentane  
D. *i* = butane; *ii* = isobutane; *iii* = neopentane

19. What is the correct assignment of common names for the following molecules?

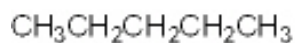

*i*

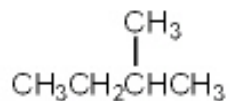

*ii*

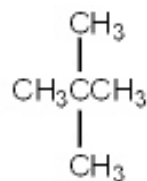

*iii*

- A. *i* = pentane; *ii* = isopentane; *iii* = neopentane  
B. *i* = neopentane; *ii* = isopentane; *iii* = pentane  
C. *i* = pentane; *ii* = neopentane; *iii* = isopentane  
D. *i* = neopentane; *ii* = pentane; *iii* = isopentane
20. What is the IUPAC name of the following compound?

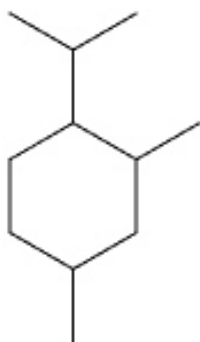

- A. 1-isopropyl-4,6-dimethylcyclohexane  
B. 1-isopropyl-2,4-dimethylcyclohexane  
C. 4-isopropyl-1,3-dimethylcyclohexane  
D. 4-isopropyl-1,5-dimethylcyclohexane
21. What is the IUPAC name of the following compound?

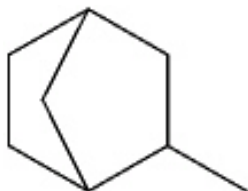

- A. 1-methylbicyclo[2.2.1]heptane  
B. 2-methylbicyclo[2.2.1]heptane  
C. 3-methylbicyclo[2.2.1]heptane  
D. 4-methylbicyclo[2.2.1]heptane

22. What is the IUPAC name of the following compound?

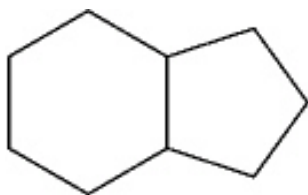

- A. bicyclo[4.3]nonane
- B. bicyclo[4.3.0]nonane
- C. bicyclo[6.5]nonane
- D. bicyclo[6.5.0]nonane

23. What is the IUPAC name for the following compound?

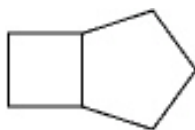

- A. cycloheptane
- B. bicyclo[3.2.0]heptane
- C. bicyclo[5.4]heptane
- D. cyclobutylcyclopentane

24. What is the IUPAC name for the following compound?



- A. bicyclo[5.4.3]octane
- B. bicyclo[3.2.1]octane
- C. bicyclo[3.2.1]hexane
- D. bicyclo[2.2.1]octane

25. Which of the following Newman projections does *not* represent 2-methylhexane?

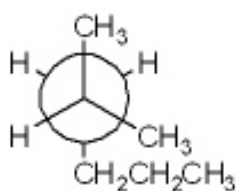

**1**

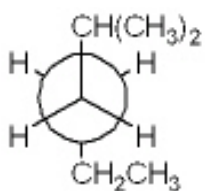

**2**

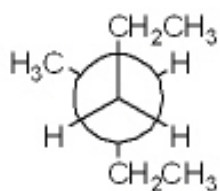

**3**

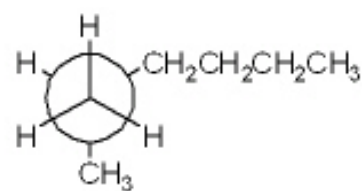

**4**

- A. 1
- B. 2
- C. 3
- D. 4

26. Which of the following Newman projections represents 2,4-dimethylpentane?

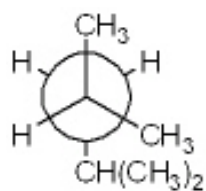

**1**

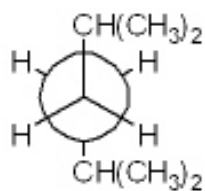

**2**

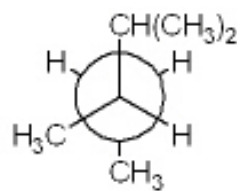

**3**

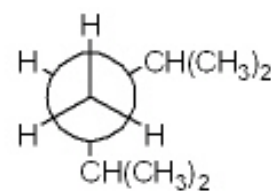

**4**

- A. 1
- B. 2
- C. 3
- D. 4

27. Which of the following Newman projections represents the most stable conformation of 2,3-dimethylbutane?

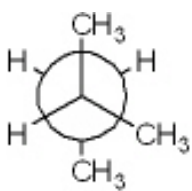

**1**

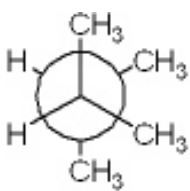

**2**

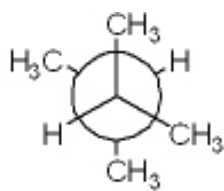

**3**

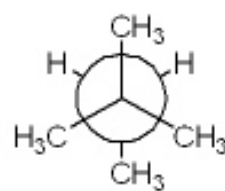

**4**

- A. 1
- B. 2
- C. 3
- D. 4

28. Which of the following Newman projections represents the most stable conformation of 2-methylbutane?

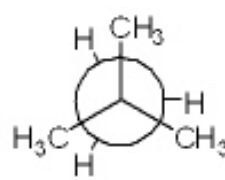
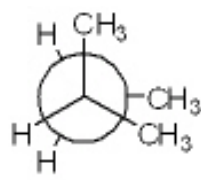
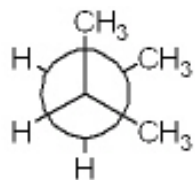
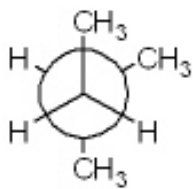

- A. 1
- B. 2
- C. 3
- D. 4

29. Which of the following cycloalkanes has the most ring strain?

- A. cyclopropane
- B. cyclobutane
- C. cyclopentane
- D. cyclohexane

30. Which of the following cycloalkanes has the least ring strain?

- A. cyclopropane
- B. cyclopentane
- C. cyclohexane
- D. cycloheptane

31. Which of the following structures represents *trans*-1,3-dimethylcyclohexane?

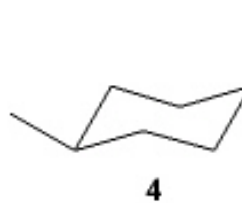
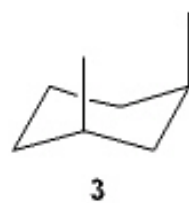
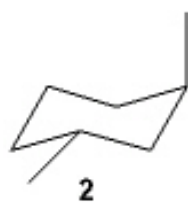
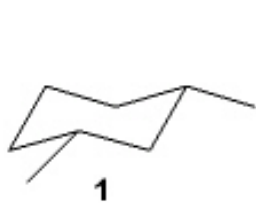

- A. 1
- B. 2
- C. 3
- D. 4



32. Which of the following structures represents *trans*-1,2-dimethylcyclohexane?



- A. 1
- B. 2
- C. 3
- D. 4

33. Which of the following is the most stable conformation of *cis*-1-isopropyl-3-methylcyclohexane?

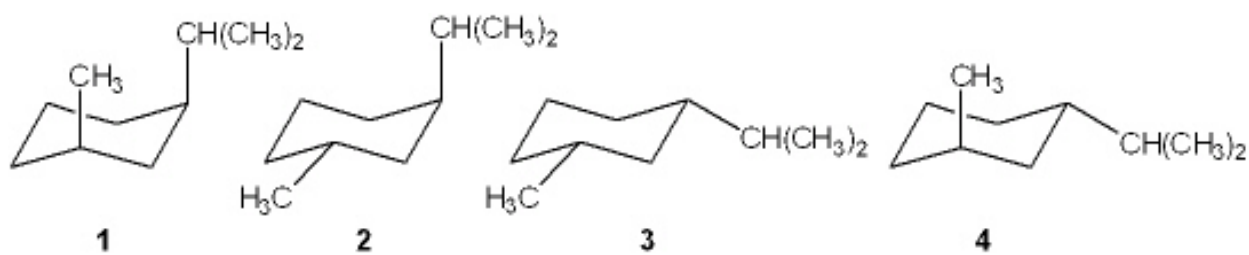

- A. 1
- B. 2
- C. 3
- D. 4

34. Which of the following is the most stable conformation of *trans*-1-ethyl-3-methylcyclohexane?

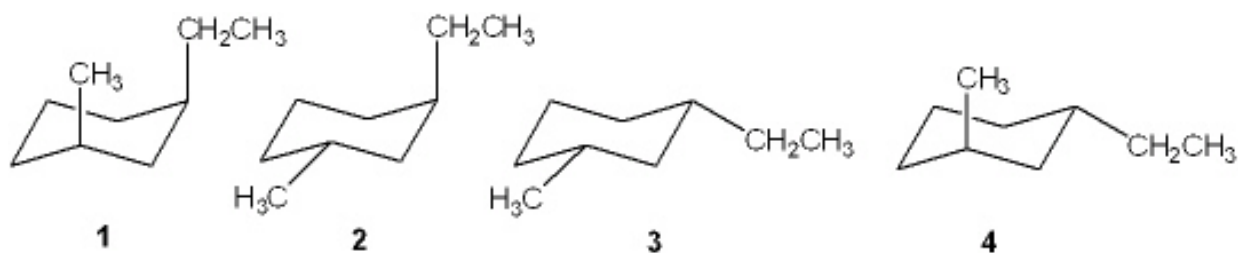

- A. 1
- B. 2
- C. 3
- D. 4

35. Which of the following alkanes has the highest boiling point?

- A. propane
- B. butane
- C. pentane
- D. hexane

36. Which of the following alkanes has the highest boiling point?

- A. 2,3-dimethylbutane
- B. 2-methylpentane
- C. 3-methylpentane
- D. hexane

37. What is the IUPAC name of the following compound?

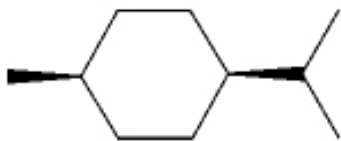

- A. *trans*-1-isopropyl-4-methylcyclohexane
- B. *cis*-1-isopropyl-4-methylcyclohexane
- C. *cis*-2-isopropyl-5-methylcyclohexane
- D. *cis*-1-*tert*-butyl-4-methylcyclohexane

38. What is the IUPAC name of the following compound?

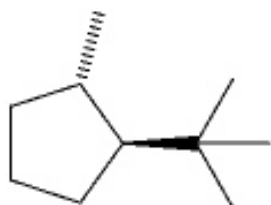

- A. *trans*-1-isopropyl-4-methylcyclopentane
- B. *cis*-1-*tert*-butyl-2-methylcyclopentane
- C. *trans*-1-*tert*-butyl-2-methylcyclopentane
- D. *cis*-1-isopropyl-2-methylcyclopentane

39. Which one of the following structures represents a different compound from the other three?

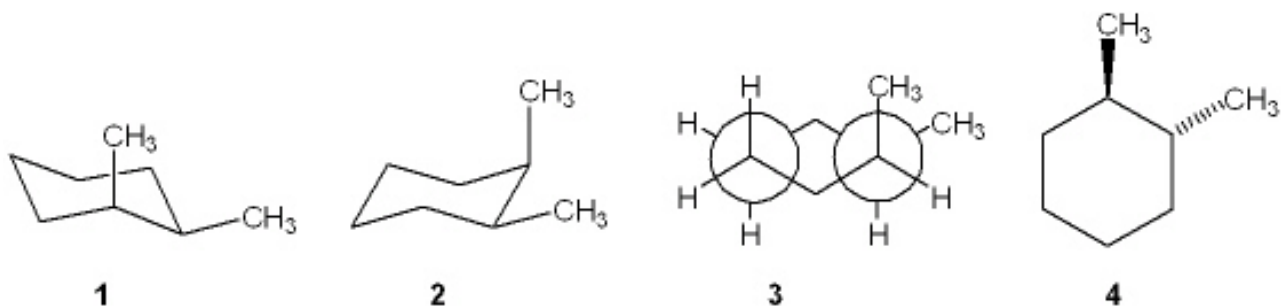

- A. 1
- B. 2
- C. 3
- D. 4

40. Which one of the following structures represents a different compound from the other three?

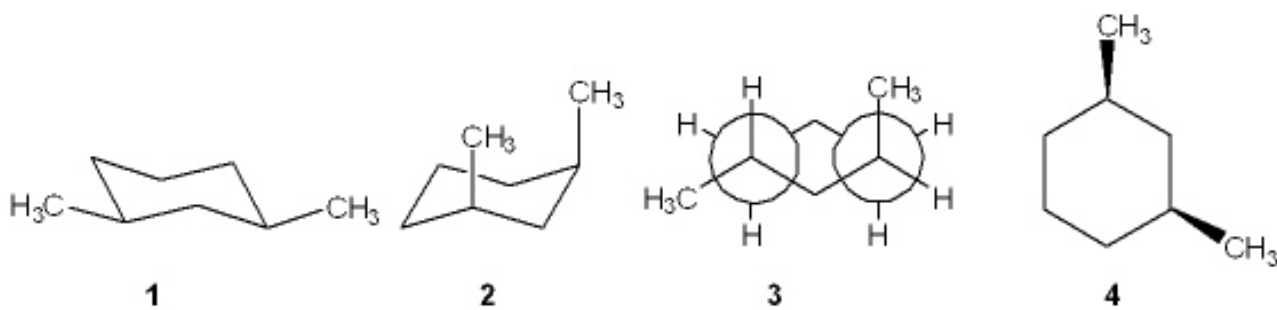

- A. 1
- B. 2
- C. 3
- D. 4

41. In which of the following compounds are all of the carbon atoms in the same plane?

- A. cyclopropane
- B. cyclobutane
- C. cyclopentane
- D. cyclohexane

42. Which of the following compounds can adopt a chair conformation in which there are no axial methyl groups?
- A. 1,1-dimethylcyclohexane
  - B. *cis*-1,2-dimethylcyclohexane
  - C. *trans*-1,2-dimethylcyclohexane
  - D. *cis*-1,3-dimethylcyclohexane
43. Which of the following compounds can adopt a chair conformation in which there are no axial methyl groups?
- A. *cis*-1,2-dimethylcyclohexane
  - B. *cis*-1,3-dimethylcyclohexane
  - C. *trans*-1,3-dimethylcyclohexane
  - D. *cis*-1,4-dimethylcyclohexane
44. Which of the following statements is not true regarding the conformation of substituted cyclohexanes?
- A. ring inversion of cyclohexanes between two chair conformations takes place via a boat conformation
  - B. substituted cyclohexanes are destabilized by 1,3-diaxial interactions
  - C. the boat conformation of cyclohexane is more stable than the chair conformation
  - D. the relative amount of two conformations of substituted cyclohexanes can be determined from the difference in strain energy
45. What is the approximate dihedral angle between the two chlorine atoms in *cis*-1,2-dichlorocyclohexane?
- A.  $0^\circ$
  - B.  $60^\circ$
  - C.  $120^\circ$
  - D.  $180^\circ$
46. What is the approximate dihedral angle between the two chlorine atoms in the diequatorial conformation of *trans*-1,2-dichlorocyclohexane?
- A.  $0^\circ$
  - B.  $60^\circ$
  - C.  $120^\circ$
  - D.  $180^\circ$
47. What is the approximate dihedral angle between the two chlorine atoms in the diaxial conformation of *trans*-1,2-dichlorocyclohexane?
- A.  $0^\circ$
  - B.  $60^\circ$
  - C.  $120^\circ$
  - D.  $180^\circ$

48. Which of the following is *not* true regarding the properties of alkanes?
- A. alkanes are nonpolar
  - B. alkanes burn in air to give  $\text{H}_2\text{O}$  and  $\text{CO}_2$
  - C. alkanes are highly miscible with water
  - D. the strongest intermolecular force between alkane molecules is the van der Waals interaction
49. Which of the following undergoes the most exothermic combustion?
- A. octane
  - B. 2-methylheptane
  - C. 2,2-dimethylhexane
  - D. 2,2,3,3-tetramethylbutane
50. How many moles of molecular oxygen ( $\text{O}_2$ ) are consumed in the complete combustion of one mole of octane ( $\text{C}_8\text{H}_{18}$ )?
- A. 12.5
  - B. 13
  - C. 17
  - D. 26
51. How many moles of molecular oxygen ( $\text{O}_2$ ) are consumed in the complete combustion of one mole of hexane ( $\text{C}_6\text{H}_{14}$ )?
- A. 6
  - B. 9.5
  - C. 12.5
  - D. 14
52. Which of the following statements is *not* true?
- A. Combustion of an alkane is an exothermic reaction.
  - B. The heat of combustion of propane is three times that of methane.
  - C. The constitutional isomers of  $\text{C}_7\text{H}_{16}$  have different heats of combustion from one another
  - D. The products of combustion of an alkane are  $\text{H}_2\text{O}$  and  $\text{CO}_2$ .

53. Which of the following is the steroid nucleus?

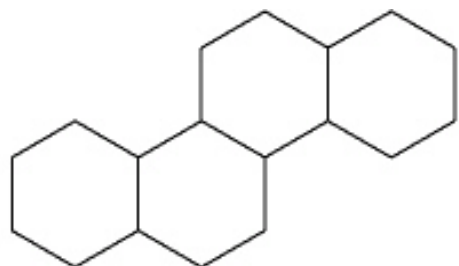

1

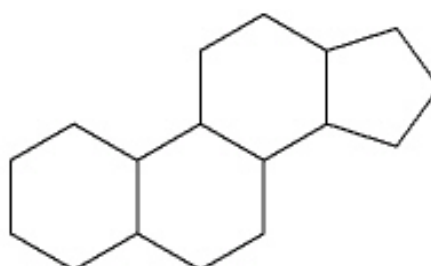

2

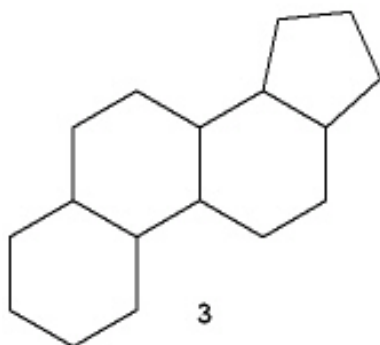

3

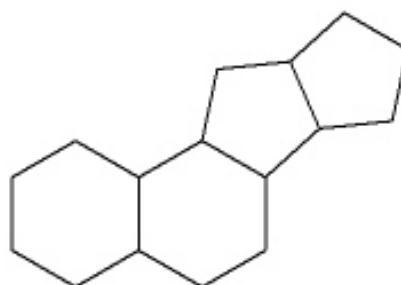

4

- A. 1
- B. 2
- C. 3
- D. 4

54. Which of the following cycloalkanes has the largest heat of combustion?

- A. cyclopropane
- B. cyclobutane
- C. cyclopentane
- D. cyclohexane

55. Which of the following cycloalkanes has the largest heat of combustion per carbon atom?

- A. cyclopropane
- B. cyclopentane
- C. cyclohexane
- D. cycloheptane

56. Which of the following cycloalkanes has the smallest heat of combustion per carbon atom?

- A. cyclopropane
- B. cyclopentane
- C. cyclohexane
- D. cycloheptane

57. Which of the following structures is different from the other three?

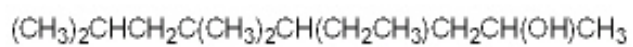
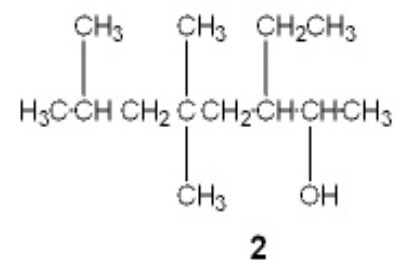
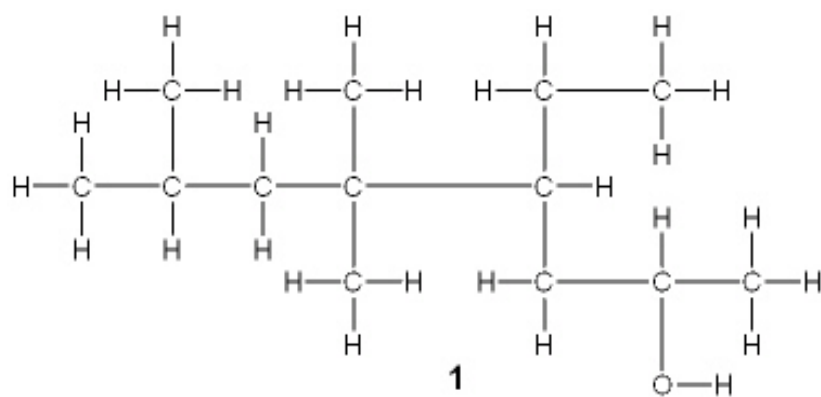

**3**

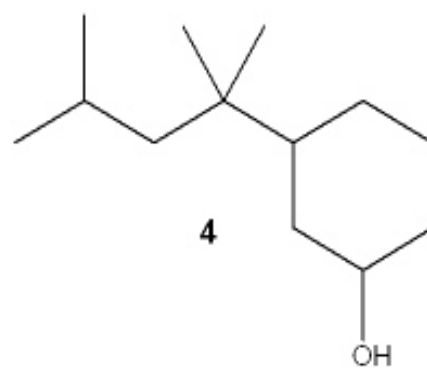

- A. **1**
- B. **2**
- C. **3**
- D. **4**

58. Which of the following structures is different from the other three?

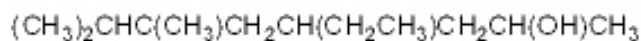

**1**

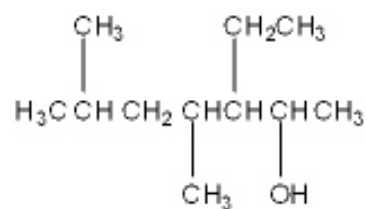

**2**

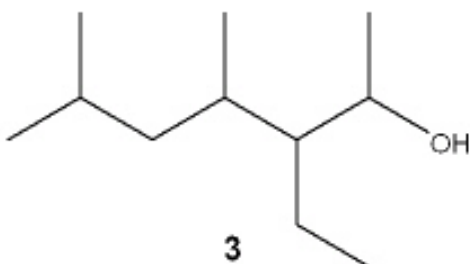

**3**

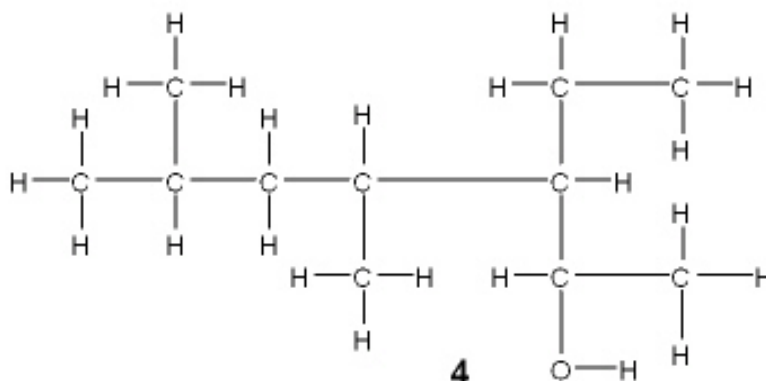

**4**

- A. **1**
- B. **2**
- C. **3**
- D. **4**

59. Which of the following substituted cyclohexanes has the most negative value of  $\Delta G^\circ$  for ring flipping from the conformation in which the substituent is axial to the one where it is equatorial?

- A. methylcyclohexane
- B. chlorocyclohexane
- C. isopropylcyclohexane
- D. ethynylcyclohexane

60. Which of the following substituted cyclohexanes has the most negative value of  $\Delta G^\circ$  for ring flipping from the conformation in which the substituent is axial to the one where it is equatorial?

- A. fluorocyclohexane
- B. methylcyclohexane
- C. ethylcyclohexane
- D. *tert*-butylcyclohexane



## CHAPTER 2--ALKANES AND CYCLOALKANES Key

1. Approximately how long is a C-C single bond of an alkane?
  - A. 111 pm
  - B. 134 pm
  - C. 142 pm
  - D. 153 pm**
2. What is the approximate C-C-C bond angle in propane?
  - A. 180°
  - B. 120°
  - C. 109°**
  - D. 90°
3. What is the name of the linear hydrocarbon with the molecular formula  $C_7H_{16}$ ?
  - A. hexane
  - B. heptane**
  - C. decane
  - D. undecane
4. What is the name of the linear hydrocarbon with the molecular formula  $C_{11}H_{24}$ ?
  - A. heptane
  - B. decane
  - C. undecane**
  - D. eicosane
5. How many hydrogen atoms are there in nonane, the linear hydrocarbon with nine carbon atoms?
  - A. 16
  - B. 18
  - C. 20**
  - D. 22
6. How many hydrogen atoms are there in dodecane, the linear hydrocarbon with twelve carbon atoms?
  - A. 12
  - B. 20
  - C. 24
  - D. 26**

7. How many constitutional isomers are there with the molecular formula  $C_4H_{10}$ ?
- A. 2  
B. 3  
C. 4  
D. 5
8. How many constitutional isomers are there with the molecular formula  $C_5H_{12}$ ?
- A. 2  
B. 3  
C. 4  
D. 5
9. How many constitutional isomers are there with the molecular formula  $C_6H_{14}$ ?
- A. 3  
B. 4  
C. 5  
D. 8
10. What is the IUPAC name of the following compound?

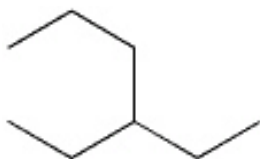

- A. 3-propylpentane  
B. 1,1-diethylpropane  
C. 3-ethylhexane  
D. isooctane
11. What is the IUPAC name of the following compound?

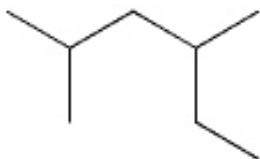

- A. 2-ethyl-4-methylpentane  
B. 2,4-dimethylhexane  
C. 3,5-dimethylhexane  
D. 1,1,3-trimethylpentane

12. What is the IUPAC name of the following compound?

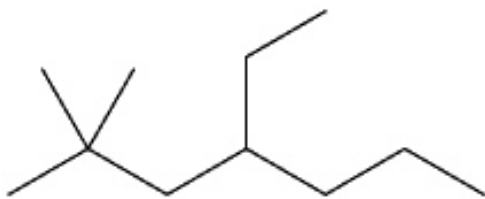

- A. 2,2-dimethyl-4-ethylheptane
- B. 4-ethyl-2,2-dimethyl-heptane**
- C. 6,6-dimethyl-4-ethylheptane
- D. 4-ethyl-6,6-dimethyl-heptane

13. What is the IUPAC name of the following compound?

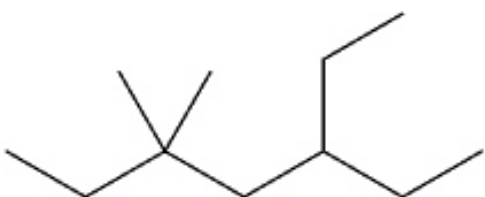

- A. 5,5-dimethyl-3-ethylheptane
- B. 5-ethyl-3,3-dimethyl-heptane
- C. 3,3-dimethyl-5-ethylheptane
- D. 3-ethyl-5,5-dimethyl-heptane**

14. What is the IUPAC name of the following compound?

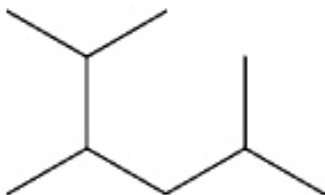

- A. 2-isopropyl-5-methylpentane
- B. 5-isopropyl-2-methylpentane
- C. 2,3,5-trimethylhexane**
- D. 1,2-diisopropylpropane

15. What is the IUPAC name of the following compound?

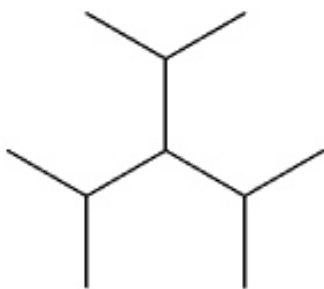

- A. 2,4-dimethyl-3-isopropyl-pentane
- B. 3-isopropyl-1,5-dimethylpentane
- C. 3-isopropyl-2,4-dimethylpentane**
- D. triisopropylmethane

16. Which of the following compounds has 1°, 2°, 3° and 4° carbon atoms?

- A. hexane
- B. 2-methylhexane
- C. 2,2-dimethylhexane
- D. 2,2,3-trimethylhexane**

17. Which of the following compounds has only 1° and 3° carbon atoms?

- A. hexane
- B. 2-methylpentane
- C. 3-methylpentane
- D. 2,3-dimethylbutane**

18. What is the correct assignment of common names for the following molecules?

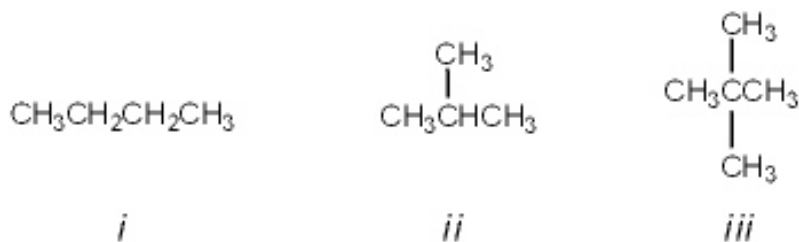

- A. *i* = butane; *ii* = neopentane; *iii* = isopentane
- B. *i* = neobutane; *ii* = isobutane; *iii* = pentane
- C. *i* = butane; *ii* = isobutane; *iii* = isopentane
- D. *i* = butane; *ii* = isobutane; *iii* = neopentane**

19. What is the correct assignment of common names for the following molecules?

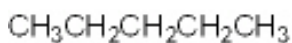

*i*

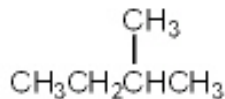

*ii*

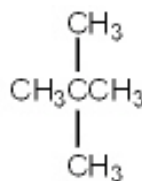

*iii*

- A. *i* = pentane; *ii* = isopentane; *iii* = neopentane  
B. *i* = neopentane; *ii* = isopentane; *iii* = pentane  
C. *i* = pentane; *ii* = neopentane; *iii* = isopentane  
D. *i* = neopentane; *ii* = pentane; *iii* = isopentane
20. What is the IUPAC name of the following compound?

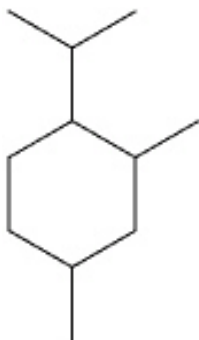

- A. 1-isopropyl-4,6-dimethylcyclohexane  
**B.** 1-isopropyl-2,4-dimethylcyclohexane  
C. 4-isopropyl-1,3-dimethylcyclohexane  
D. 4-isopropyl-1,5-dimethylcyclohexane
21. What is the IUPAC name of the following compound?

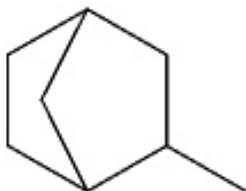

- A. 1-methylbicyclo[2.2.1]heptane  
**B.** 2-methylbicyclo[2.2.1]heptane  
C. 3-methylbicyclo[2.2.1]heptane  
D. 4-methylbicyclo[2.2.1]heptane

22. What is the IUPAC name of the following compound?

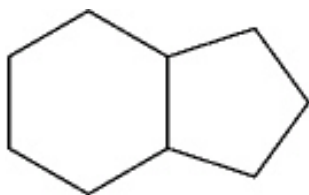

- A. bicyclo[4.3]nonane
- B. bicyclo[4.3.0]nonane**
- C. bicyclo[6.5]nonane
- D. bicyclo[6.5.0]nonane

23. What is the IUPAC name for the following compound?

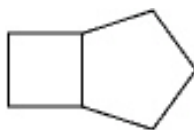

- A. cycloheptane
- B. bicyclo[3.2.0]heptane**
- C. bicyclo[5.4]heptane
- D. cyclobutylcyclopentane

24. What is the IUPAC name for the following compound?



- A. bicyclo[5.4.3]octane
- B. bicyclo[3.2.1]octane**
- C. bicyclo[3.2.1]hexane
- D. bicyclo[2.2.1]octane

25. Which of the following Newman projections does *not* represent 2-methylhexane?

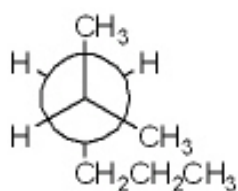

**1**

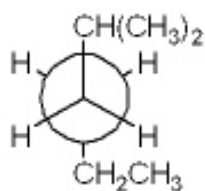

**2**

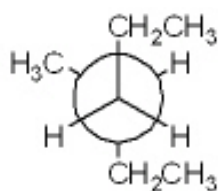

**3**

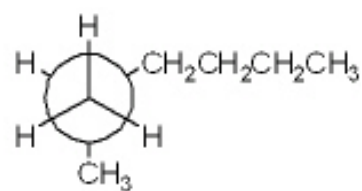

**4**

- A. **1**
- B. **2**
- C. **3**
- D. **4**

26. Which of the following Newman projections represents 2,4-dimethylpentane?

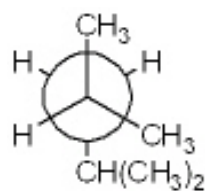

**1**

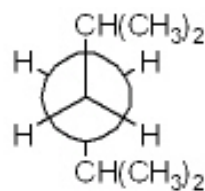

**2**

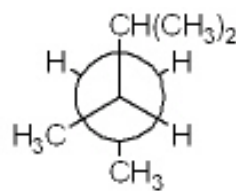

**3**

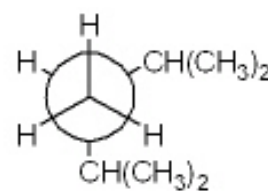

**4**

- A. **1**
- B. **2**
- C. **3**
- D. **4**

27. Which of the following Newman projections represents the most stable conformation of 2,3-dimethylbutane?

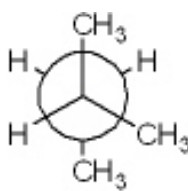

**1**

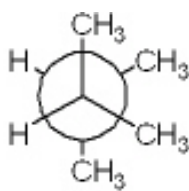

**2**

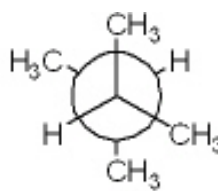

**3**

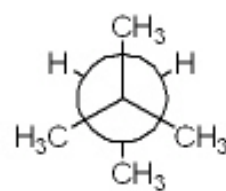

**4**

- A. **1**
- B. **2**
- C. **3**
- D. **4**

28. Which of the following Newman projections represents the most stable conformation of 2-methylbutane?

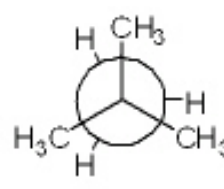
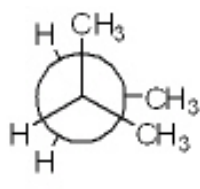
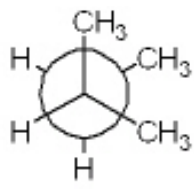
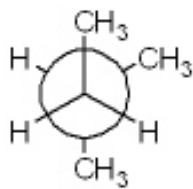

- A. 1  
 B. 2  
 C. 3  
 D. 4
29. Which of the following cycloalkanes has the most ring strain?

- A. cyclopropane  
 B. cyclobutane  
 C. cyclopentane  
 D. cyclohexane

30. Which of the following cycloalkanes has the least ring strain?

- A. cyclopropane  
 B. cyclopentane  
 C. cyclohexane  
 D. cycloheptane

31. Which of the following structures represents *trans*-1,3-dimethylcyclohexane?

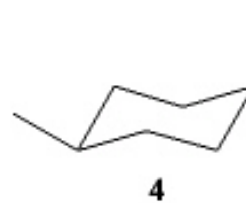
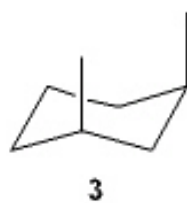
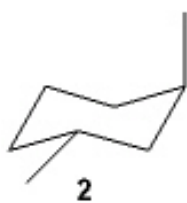
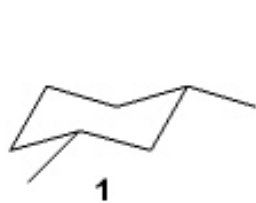

- A. 1  
 B. 2  
 C. 3  
 D. 4



32. Which of the following structures represents *trans*-1,2-dimethylcyclohexane?



- A. 1
- B. 2**
- C. 3
- D. 4

33. Which of the following is the most stable conformation of *cis*-1-isopropyl-3-methylcyclohexane?

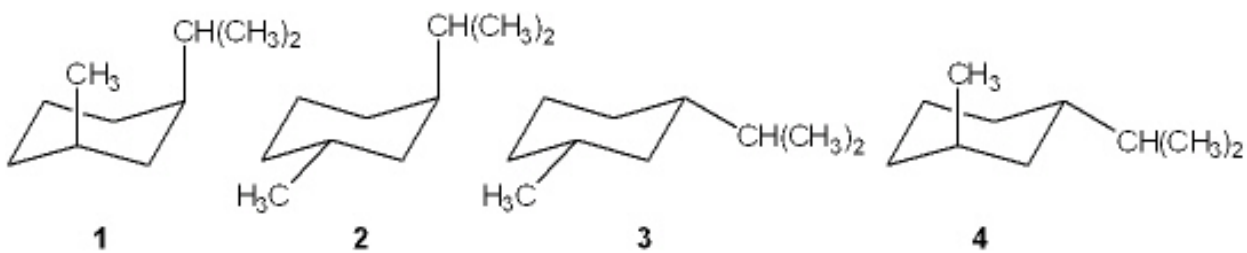

- A. 1
- B. 2
- C. 3**
- D. 4

34. Which of the following is the most stable conformation of *trans*-1-ethyl-3-methylcyclohexane?

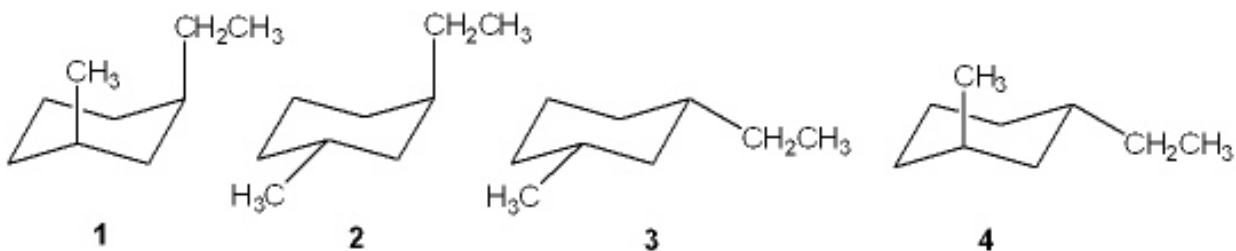

- A. 1
- B. 2
- C. 3
- D. 4**

35. Which of the following alkanes has the highest boiling point?

- A. propane
- B. butane
- C. pentane
- D. hexane**

36. Which of the following alkanes has the highest boiling point?

- A. 2,3-dimethylbutane
- B. 2-methylpentane
- C. 3-methylpentane
- D. hexane**

37. What is the IUPAC name of the following compound?

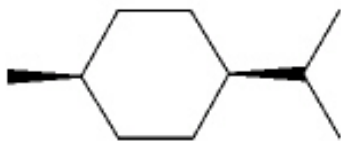

- A. *trans*-1-isopropyl-4-methylcyclohexane
- B. *cis*-1-isopropyl-4-methylcyclohexane**
- C. *cis*-2-isopropyl-5-methylcyclohexane
- D. *cis*-1-*tert*-butyl-4-methylcyclohexane

38. What is the IUPAC name of the following compound?

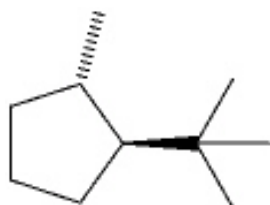

- A. *trans*-1-isopropyl-4-methylcyclopentane
- B. *cis*-1-*tert*-butyl-2-methylcyclopentane
- C. *trans*-1-*tert*-butyl-2-methylcyclopentane**
- D. *cis*-1-isopropyl-2-methylcyclopentane

39. Which one of the following structures represents a different compound from the other three?

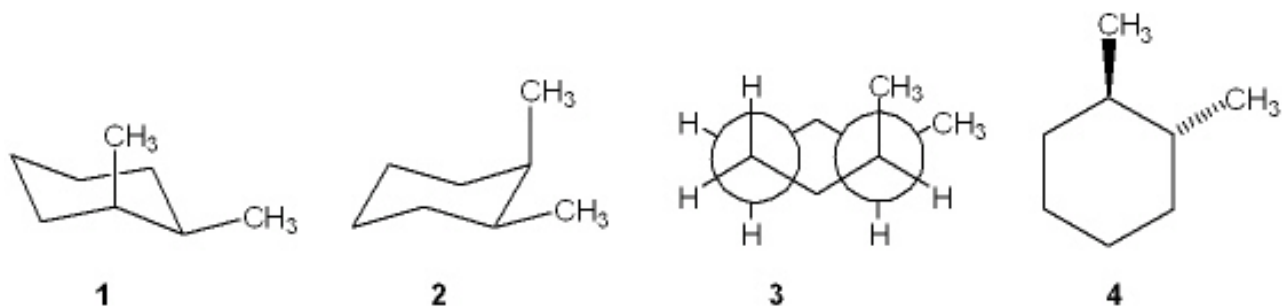

- A. 1
- B. 2
- C. 3
- D. 4**

40. Which one of the following structures represents a different compound from the other three?

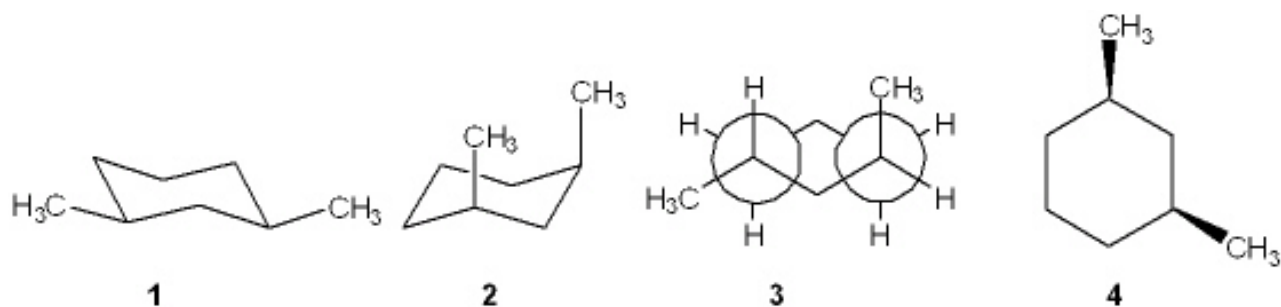

- A. 1
- B. 2
- C. 3**
- D. 4

41. In which of the following compounds are all of the carbon atoms in the same plane?

- A. cyclopropane**
- B. cyclobutane
- C. cyclopentane
- D. cyclohexane

42. Which of the following compounds can adopt a chair conformation in which there are no axial methyl groups?
- A. 1,1-dimethylcyclohexane
  - B. *cis*-1,2-dimethylcyclohexane
  - C.** *trans*-1,2-dimethylcyclohexane
  - D. *cis*-1,3-dimethylcyclohexane
43. Which of the following compounds can adopt a chair conformation in which there are no axial methyl groups?
- A. *cis*-1,2-dimethylcyclohexane
  - B.** *cis*-1,3-dimethylcyclohexane
  - C. *trans*-1,3-dimethylcyclohexane
  - D. *cis*-1,4-dimethylcyclohexane
44. Which of the following statements is not true regarding the conformation of substituted cyclohexanes?
- A. ring inversion of cyclohexanes between two chair conformations takes place via a boat conformation
  - B. substituted cyclohexanes are destabilized by 1,3-diaxial interactions
  - C.** the boat conformation of cyclohexane is more stable than the chair conformation
  - D. the relative amount of two conformations of substituted cyclohexanes can be determined from the difference in strain energy
45. What is the approximate dihedral angle between the two chlorine atoms in *cis*-1,2-dichlorocyclohexane?
- A. 0°
  - B.** 60°
  - C. 120°
  - D. 180°
46. What is the approximate dihedral angle between the two chlorine atoms in the diequatorial conformation of *trans*-1,2-dichlorocyclohexane?
- A. 0°
  - B.** 60°
  - C. 120°
  - D. 180°
47. What is the approximate dihedral angle between the two chlorine atoms in the diaxial conformation of *trans*-1,2-dichlorocyclohexane?
- A. 0°
  - B. 60°
  - C. 120°
  - D.** 180°

48. Which of the following is *not* true regarding the properties of alkanes?
- A. alkanes are nonpolar
  - B. alkanes burn in air to give  $\text{H}_2\text{O}$  and  $\text{CO}_2$
  - C.** alkanes are highly miscible with water
  - D. the strongest intermolecular force between alkane molecules is the van der Waals interaction
49. Which of the following undergoes the most exothermic combustion?
- A.** octane
  - B. 2-methylheptane
  - C. 2,2-dimethylhexane
  - D. 2,2,3,3-tetramethylbutane
50. How many moles of molecular oxygen ( $\text{O}_2$ ) are consumed in the complete combustion of one mole of octane ( $\text{C}_8\text{H}_{18}$ )?
- A.** 12.5
  - B. 13
  - C. 17
  - D. 26
51. How many moles of molecular oxygen ( $\text{O}_2$ ) are consumed in the complete combustion of one mole of hexane ( $\text{C}_6\text{H}_{14}$ )?
- A. 6
  - B.** 9.5
  - C. 12.5
  - D. 14
52. Which of the following statements is *not* true?
- A. Combustion of an alkane is an exothermic reaction.
  - B.** The heat of combustion of propane is three times that of methane.
  - C. The constitutional isomers of  $\text{C}_7\text{H}_{16}$  have different heats of combustion from one another
  - D. The products of combustion of an alkane are  $\text{H}_2\text{O}$  and  $\text{CO}_2$ .

53. Which of the following is the steroid nucleus?

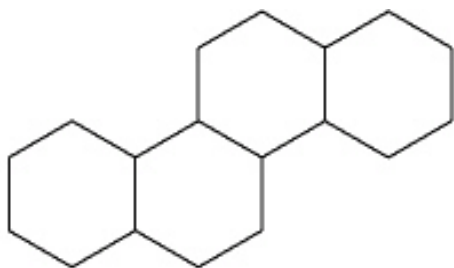

1

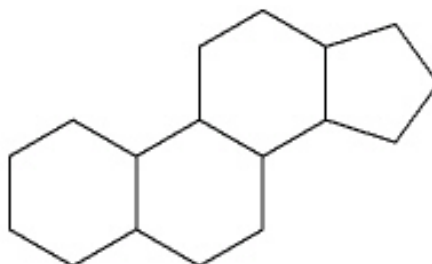

2

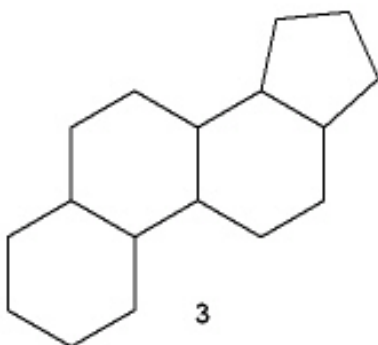

3

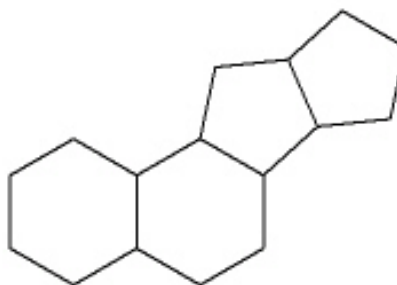

4

- A. 1
- B. 2**
- C. 3
- D. 4

54. Which of the following cycloalkanes has the largest heat of combustion?

- A. cyclopropane
- B. cyclobutane
- C. cyclopentane
- D. cyclohexane**

55. Which of the following cycloalkanes has the largest heat of combustion per carbon atom?

- A. cyclopropane**
- B. cyclopentane
- C. cyclohexane
- D. cycloheptane

56. Which of the following cycloalkanes has the smallest heat of combustion per carbon atom?

- A. cyclopropane
- B. cyclopentane
- C. cyclohexane**
- D. cycloheptane

57. Which of the following structures is different from the other three?

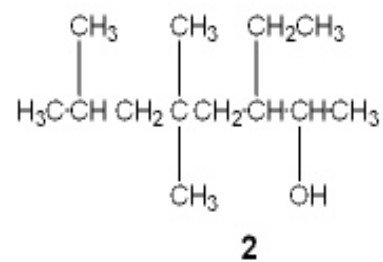
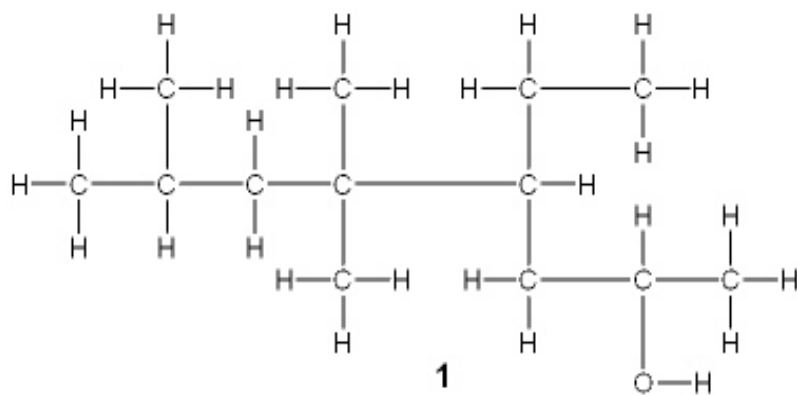

**3**

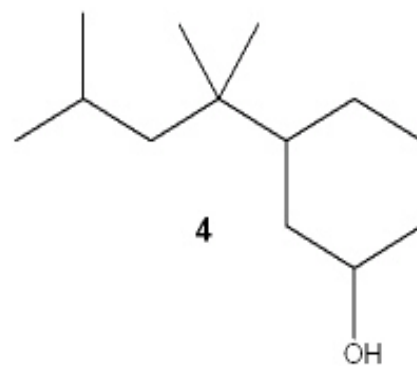

- A. **1**
- B. 2**
- C. **3**
- D. **4**

58. Which of the following structures is different from the other three?

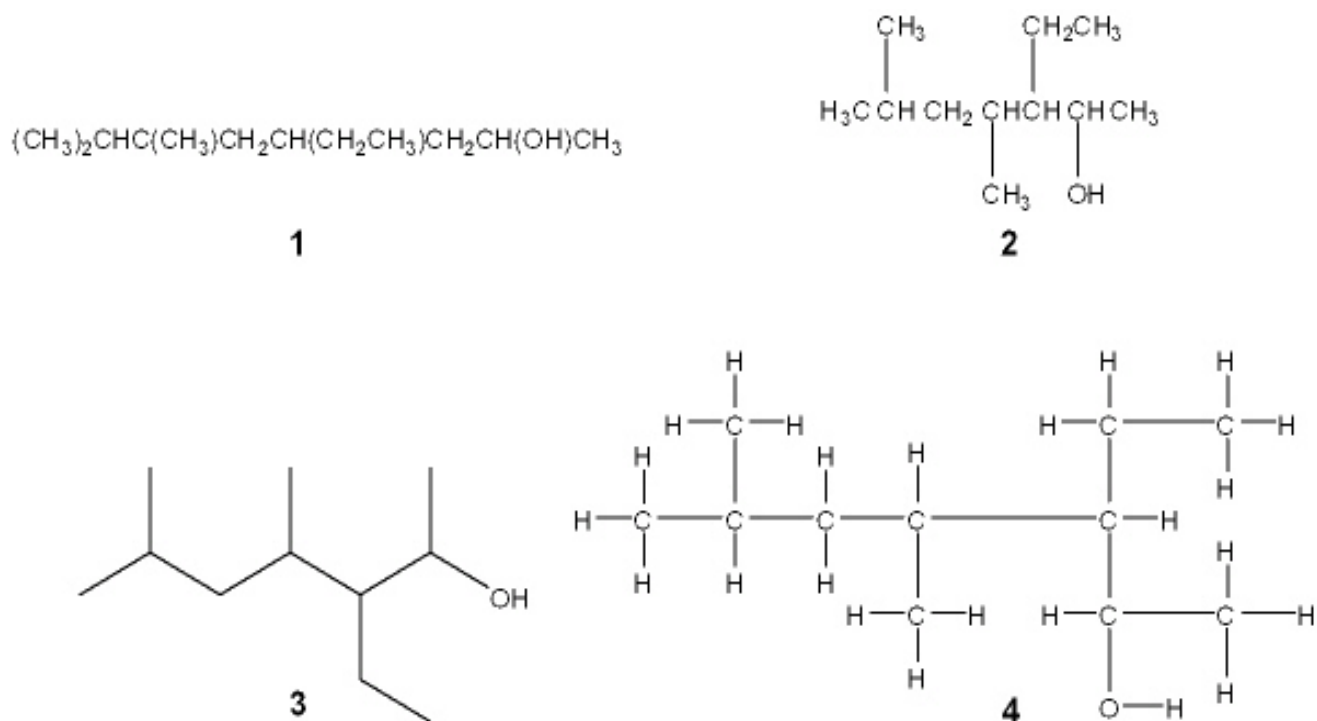

- A. **1**  
 B. **2**  
 C. **3**  
 D. **4**
59. Which of the following substituted cyclohexanes has the most negative value of  $\Delta G^\circ$  for ring flipping from the conformation in which the substituent is axial to the one where it is equatorial?
- A. methylcyclohexane  
 B. chlorocyclohexane  
 C. **isopropylcyclohexane**  
 D. ethynylcyclohexane
60. Which of the following substituted cyclohexanes has the most negative value of  $\Delta G^\circ$  for ring flipping from the conformation in which the substituent is axial to the one where it is equatorial?
- A. fluorocyclohexane  
 B. methylcyclohexane  
 C. ethylcyclohexane  
 D. **tert-butylcyclohexane**