

Circuit Elements

Assessment Problems

AP 2.1

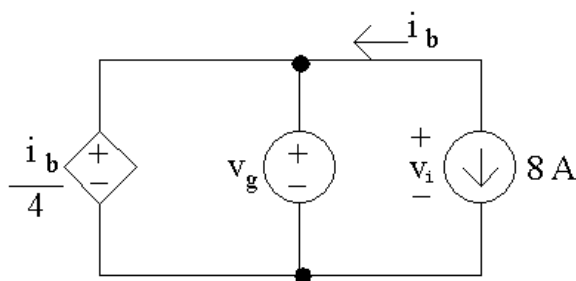

- [a] Note that the current i_b is in the same circuit branch as the 8 A current source; however, i_b is defined in the opposite direction of the current source. Therefore,

$$i_b = -8 \text{ A}$$

Next, note that the dependent voltage source and the independent voltage source are in parallel with the same polarity. Therefore, their voltages are equal, and

$$v_g = \frac{i_b}{4} = \frac{-8}{4} = -2 \text{ V}$$

- [b] To find the power associated with the 8 A source, we need to find the voltage drop across the source, v_i . Note that the two independent sources are in parallel, and that the voltages v_g and v_i have the same polarities, so these voltages are equal:

$$v_i = v_g = -2 \text{ V}$$

Using the passive sign convention,

$$p_s = (8 \text{ A})(v_i) = (8 \text{ A})(-2 \text{ V}) = -16 \text{ W}$$

Thus the current source generated 16 W of power.

AP 2.2

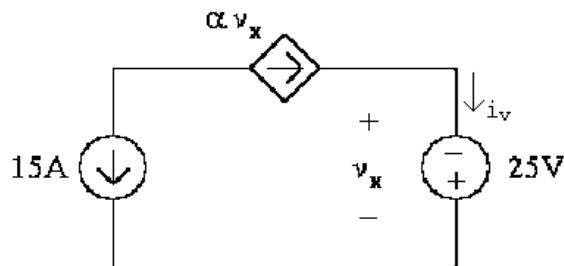

- [a] Note from the circuit that $v_x = -25$ V. To find α note that the two current sources are in the same branch of the circuit but their currents flow in opposite directions. Therefore

$$\alpha v_x = -15 \text{ A}$$

Solve the above equation for α and substitute for v_x ,

$$\alpha = \frac{-15 \text{ A}}{v_x} = \frac{-15 \text{ A}}{-25 \text{ V}} = 0.6 \text{ A/V}$$

- [b] To find the power associated with the voltage source we need to know the current, i_v . Note that this current is in the same branch of the circuit as the dependent current source and these two currents flow in the same direction. Therefore, the current i_v is the same as the current of the dependent source:

$$i_v = \alpha v_x = (0.6)(-25) = -15 \text{ A}$$

Using the passive sign convention,

$$p_s = -(i_v)(25 \text{ V}) = -(-15 \text{ A})(25 \text{ V}) = 375 \text{ W}.$$

Thus the voltage source dissipates 375 W.

AP 2.3

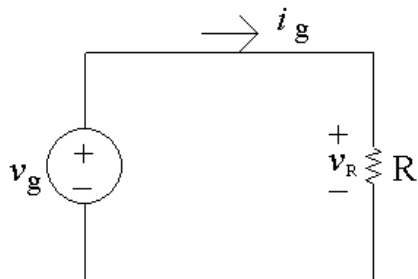

- [a] The resistor and the voltage source are in parallel and the resistor voltage and the voltage source have the same polarities. Therefore these two voltages are the same:

$$v_R = v_g = 1 \text{ kV}$$

Note from the circuit that the current through the resistor is $i_g = 5 \text{ mA}$. Use Ohm's law to calculate the value of the resistor:

$$R = \frac{v_R}{i_g} = \frac{1 \text{ kV}}{5 \text{ mA}} = 200 \text{ k}\Omega$$

Using the passive sign convention to calculate the power in the resistor,

$$p_R = (v_R)(i_g) = (1 \text{ kV})(5 \text{ mA}) = 5 \text{ W}$$

The resistor is dissipating 5 W of power.

- [b] Note from part (a) the $v_R = v_g$ and $i_R = i_g$. The power delivered by the source is thus

$$p_{\text{source}} = -v_g i_g \quad \text{so} \quad v_g = -\frac{p_{\text{source}}}{i_g} = -\frac{-3 \text{ W}}{75 \text{ mA}} = 40 \text{ V}$$

Since we now have the value of both the voltage and the current for the resistor, we can use Ohm's law to calculate the resistor value:

$$R = \frac{v_g}{i_g} = \frac{40 \text{ V}}{75 \text{ mA}} = 533.33 \Omega$$

The power absorbed by the resistor must equal the power generated by the source. Thus,

$$p_R = -p_{\text{source}} = -(-3 \text{ W}) = 3 \text{ W}$$

- [c] Again, note the $i_R = i_g$. The power dissipated by the resistor can be determined from the resistor's current:

$$p_R = R(i_R)^2 = R(i_g)^2$$

Solving for i_g ,

$$i_g^2 = \frac{p_r}{R} = \frac{480 \text{ mW}}{300 \Omega} = 0.0016 \quad \text{so} \quad i_g = \sqrt{0.0016} = 0.04 \text{ A} = 40 \text{ mA}$$

Then, since $v_R = v_g$

$$v_R = Ri_R = Ri_g = (300 \Omega)(40 \text{ mA}) = 12 \text{ V} \quad \text{so} \quad v_g = 12 \text{ V}$$

AP 2.4

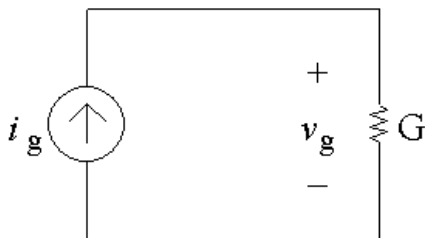

- [a] Note from the circuit that the current through the conductance G is i_g , flowing from top to bottom, because the current source and the

conductance are in the same branch of the circuit so must have the same current. The voltage drop across the current source is v_g , positive at the top, because the current source and the conductance are also in parallel so must have the same voltage. From a version of Ohm's law,

$$v_g = \frac{i_g}{G} = \frac{0.5 \text{ A}}{50 \text{ mS}} = 10 \text{ V}$$

Now that we know the voltage drop across the current source, we can find the power delivered by this source:

$$p_{\text{source}} = -v_g i_g = -(10)(0.5) = -5 \text{ W}$$

Thus the current source delivers 5 W to the circuit.

- [b] We can find the value of the conductance using the power, and the value of the current using Ohm's law and the conductance value:

$$p_g = Gv_g^2 \quad \text{so} \quad G = \frac{p_g}{v_g^2} = \frac{9}{15^2} = 0.04 \text{ S} = 40 \text{ mS}$$

$$i_g = Gv_g = (40 \text{ mS})(15 \text{ V}) = 0.6 \text{ A}$$

- [c] We can find the voltage from the power and the conductance, and then use the voltage value in Ohm's law to find the current:

$$p_g = Gv_g^2 \quad \text{so} \quad v_g^2 = \frac{p_g}{G} = \frac{8 \text{ W}}{200 \mu\text{S}} = 40,000$$

$$\text{Thus} \quad v_g = \sqrt{40,000} = 200 \text{ V}$$

$$i_g = Gv_g = (200 \mu\text{S})(200 \text{ V}) = 0.04 \text{ A} = 40 \text{ mA}$$

- AP 2.5 [a] Redraw the circuit with all of the voltages and currents labeled for every circuit element.

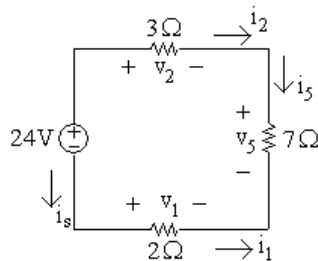

Write a KVL equation clockwise around the circuit, starting below the voltage source:

$$-24 \text{ V} + v_2 + v_5 - v_1 = 0$$

Next, use Ohm's law to calculate the three unknown voltages from the three currents:

$$v_2 = 3i_2; \quad v_5 = 7i_5; \quad v_1 = 2i_1$$

A KCL equation at the upper right node gives $i_2 = i_5$; a KCL equation at the bottom right node gives $i_5 = -i_1$; a KCL equation at the upper left node gives $i_s = -i_2$. Now replace the currents i_1 and i_2 in the Ohm's law equations with i_5 :

$$v_2 = 3i_2 = 3i_5; \quad v_5 = 7i_5; \quad v_1 = 2i_1 = -2i_5$$

Now substitute these expressions for the three voltages into the first equation:

$$24 = v_2 + v_5 - v_1 = 3i_5 + 7i_5 - (-2i_5) = 12i_5$$

$$\text{Therefore } i_5 = 24/12 = 2 \text{ A}$$

[b] $v_1 = -2i_5 = -2(2) = -4 \text{ V}$

[c] $v_2 = 3i_5 = 3(2) = 6 \text{ V}$

[d] $v_5 = 7i_5 = 7(2) = 14 \text{ V}$

[e] A KCL equation at the lower left node gives $i_s = i_1$. Since $i_1 = -i_5$, $i_s = -2 \text{ A}$. We can now compute the power associated with the voltage source:

$$p_{24} = (24)i_s = (24)(-2) = -48 \text{ W}$$

Therefore 24 V source is delivering 48 W.

AP 2.6 Redraw the circuit labeling all voltages and currents:

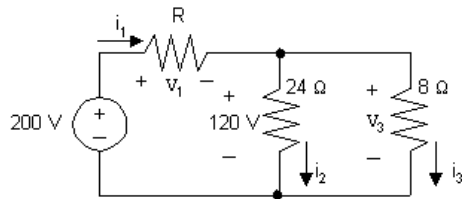

We can find the value of the unknown resistor if we can find the value of its voltage and its current. To start, write a KVL equation clockwise around the right loop, starting below the 24Ω resistor:

$$-120 \text{ V} + v_3 = 0$$

Use Ohm's law to calculate the voltage across the 8Ω resistor in terms of its current:

$$v_3 = 8i_3$$

Substitute the expression for v_3 into the first equation:

$$-120 \text{ V} + 8i_3 = 0 \quad \text{so} \quad i_3 = \frac{120}{8} = 15 \text{ A}$$

Also use Ohm's law to calculate the value of the current through the 24Ω resistor:

$$i_2 = \frac{120\text{ V}}{24\Omega} = 5\text{ A}$$

Now write a KCL equation at the top middle node, summing the currents leaving:

$$-i_1 + i_2 + i_3 = 0 \quad \text{so} \quad i_1 = i_2 + i_3 = 5 + 15 = 20\text{ A}$$

Write a KVL equation clockwise around the left loop, starting below the voltage source:

$$-200\text{ V} + v_1 + 120\text{ V} = 0 \quad \text{so} \quad v_1 = 200 - 120 = 80\text{ V}$$

Now that we know the values of both the voltage and the current for the unknown resistor, we can use Ohm's law to calculate the resistance:

$$R = \frac{v_1}{i_1} = \frac{80}{20} = 4\Omega$$

AP 2.7 [a] Plotting a graph of v_t versus i_t gives

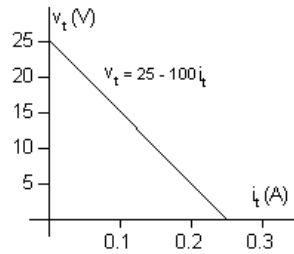

Note that when $i_t = 0$, $v_t = 25\text{ V}$; therefore the voltage source must be 25 V . Since the plot is a straight line, its slope can be used to calculate the value of resistance:

$$R = \frac{\Delta v}{\Delta i} = \frac{25 - 0}{0.25 - 0} = \frac{25}{0.25} = 100\Omega$$

A circuit model having the same $v - i$ characteristic is a 25 V source in series with a 100Ω resistor, as shown below:

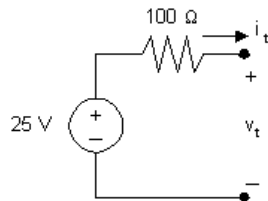

[b] Draw the circuit model from part (a) and attach a $25\ \Omega$ resistor:

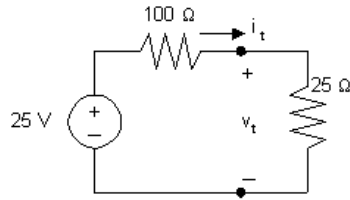

To find the power delivered to the $25\ \Omega$ resistor we must calculate the current through the $25\ \Omega$ resistor. Do this by first using KCL to recognize that the current in each of the components is i_t , flowing in a clockwise direction. Write a KVL equation in the clockwise direction, starting below the voltage source, and using Ohm's law to express the voltage drop across the resistors in the direction of the current i_t flowing through the resistors:

$$-25\text{ V} + 100i_t + 25i_t = 0 \quad \text{so} \quad 125i_t = 25 \quad \text{so} \quad i_t = \frac{25}{125} = 0.2\text{ A}$$

Thus, the power delivered to the $25\ \Omega$ resistor is

$$p_{25} = (25)i_t^2 = (25)(0.2)^2 = 1\text{ W}.$$

AP 2.8 [a] From the graph in Assessment Problem 2.7(a), we see that when $v_t = 0$, $i_t = 0.25\text{ A}$. Therefore the current source must be 0.25 A . Since the plot is a straight line, its slope can be used to calculate the value of resistance:

$$R = \frac{\Delta v}{\Delta i} = \frac{25 - 0}{0.25 - 0} = \frac{25}{0.25} = 100\ \Omega$$

A circuit model having the same $v - i$ characteristic is a 0.25 A current source in parallel with a $100\ \Omega$ resistor, as shown below:

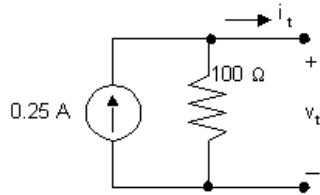

[b] Draw the circuit model from part (a) and attach a $25\ \Omega$ resistor:

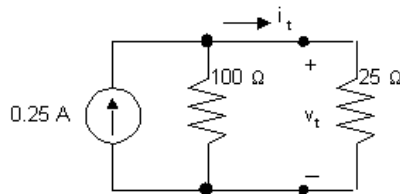

Note that by writing a KVL equation around the right loop we see that the voltage drop across both resistors is v_t . Write a KCL equation at the top center node, summing the currents leaving the node. Use Ohm's law

to specify the currents through the resistors in terms of the voltage drop across the resistors and the value of the resistors.

$$-0.25 + \frac{v_t}{100} + \frac{v_t}{25} = 0, \quad \text{so} \quad 5v_t = 25, \quad \text{thus} \quad v_t = 5 \text{ V}$$

$$p_{25} = \frac{v_t^2}{25} = 1 \text{ W}.$$

AP 2.9 First note that we know the current through all elements in the circuit except the $6 \text{ k}\Omega$ resistor (the current in the three elements to the left of the $6 \text{ k}\Omega$ resistor is i_1 ; the current in the three elements to the right of the $6 \text{ k}\Omega$ resistor is $30i_1$). To find the current in the $6 \text{ k}\Omega$ resistor, write a KCL equation at the top node:

$$i_1 + 30i_1 = i_{6\text{k}} = 31i_1$$

We can then use Ohm's law to find the voltages across each resistor in terms of i_1 . The results are shown in the figure below:

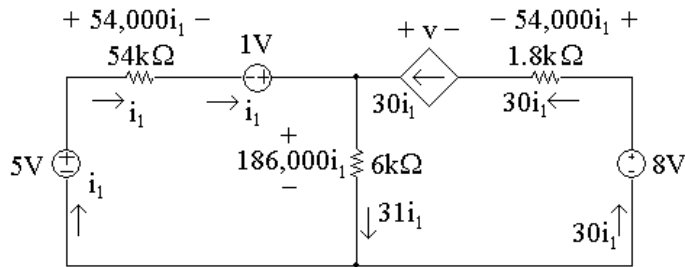

[a] To find i_1 , write a KVL equation around the left-hand loop, summing voltages in a clockwise direction starting below the 5 V source:

$$-5 \text{ V} + 54,000i_1 - 1 \text{ V} + 186,000i_1 = 0$$

Solving for i_1

$$54,000i_1 + 186,000i_1 = 6 \text{ V} \quad \text{so} \quad 240,000i_1 = 6 \text{ V}$$

Thus,

$$i_1 = \frac{6}{240,000} = 25 \mu\text{A}$$

[b] Now that we have the value of i_1 , we can calculate the voltage for each component except the dependent source. Then we can write a KVL equation for the right-hand loop to find the voltage v of the dependent source. Sum the voltages in the clockwise direction, starting to the left of the dependent source:

$$+v - 54,000i_1 + 8 \text{ V} - 186,000i_1 = 0$$

Thus,

$$v = 240,000i_1 - 8 \text{ V} = 240,000(25 \times 10^{-6}) - 8 \text{ V} = 6 \text{ V} - 8 \text{ V} = -2 \text{ V}$$

We now know the values of voltage and current for every circuit element.

Let's construct a power table:

Element	Current (μA)	Voltage (V)	Power Equation	Power (μW)
5 V	25	5	$p = -vi$	-125
54 k Ω	25	1.35	$p = Ri^2$	33.75
1 V	25	1	$p = -vi$	-25
6 k Ω	775	4.65	$p = Ri^2$	3603.75
Dep. source	750	-2	$p = -vi$	1500
1.8 k Ω	750	1.35	$p = Ri^2$	1012.5
8 V	750	8	$p = -vi$	-6000

- [c] The total power generated in the circuit is the sum of the negative power values in the power table:

$$-125 \mu\text{W} + -25 \mu\text{W} + -6000 \mu\text{W} = -6150 \mu\text{W}$$

Thus, the total power generated in the circuit is 6150 μW .

- [d] The total power absorbed in the circuit is the sum of the positive power values in the power table:

$$33.75 \mu\text{W} + 3603.75 \mu\text{W} + 1500 \mu\text{W} + 1012.5 \mu\text{W} = 6150 \mu\text{W}$$

Thus, the total power absorbed in the circuit is 6150 μW .

AP 2.10 Given that $i_\phi = 2 \text{ A}$, we know the current in the dependent source is $2i_\phi = 4 \text{ A}$. We can write a KCL equation at the left node to find the current in the 10 Ω resistor. Summing the currents leaving the node,

$$-5 \text{ A} + 2 \text{ A} + 4 \text{ A} + i_{10\Omega} = 0 \quad \text{so} \quad i_{10\Omega} = 5 \text{ A} - 2 \text{ A} - 4 \text{ A} = -1 \text{ A}$$

Thus, the current in the 10 Ω resistor is 1 A, flowing right to left, as seen in the circuit below.

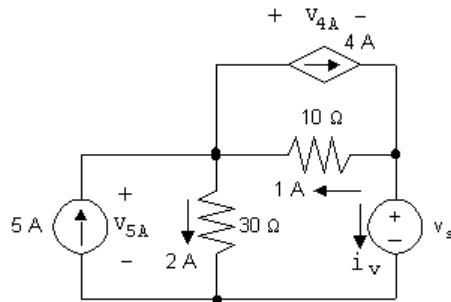

- [a] To find v_s , write a KVL equation, summing the voltages counter-clockwise around the lower right loop. Start below the voltage source.

$$-v_s + (1\text{ A})(10\ \Omega) + (2\text{ A})(30\ \Omega) = 0 \quad \text{so} \quad v_s = 10\text{ V} + 60\text{ V} = 70\text{ V}$$

- [b] The current in the voltage source can be found by writing a KCL equation at the right-hand node. Sum the currents leaving the node

$$-4\text{ A} + 1\text{ A} + i_v = 0 \quad \text{so} \quad i_v = 4\text{ A} - 1\text{ A} = 3\text{ A}$$

The current in the voltage source is 3 A, flowing top to bottom. The power associated with this source is

$$p = vi = (70\text{ V})(3\text{ A}) = 210\text{ W}$$

Thus, 210 W are absorbed by the voltage source.

- [c] The voltage drop across the independent current source can be found by writing a KVL equation around the left loop in a clockwise direction:

$$-v_{5A} + (2\text{ A})(30\ \Omega) = 0 \quad \text{so} \quad v_{5A} = 60\text{ V}$$

The power associated with this source is

$$p = -v_{5A}i = -(60\text{ V})(5\text{ A}) = -300\text{ W}$$

This source thus delivers 300 W of power to the circuit.

- [d] The voltage across the controlled current source can be found by writing a KVL equation around the upper right loop in a clockwise direction:

$$+v_{4A} + (10\ \Omega)(1\text{ A}) = 0 \quad \text{so} \quad v_{4A} = -10\text{ V}$$

The power associated with this source is

$$p = v_{4A}i = (-10\text{ V})(4\text{ A}) = -40\text{ W}$$

This source thus delivers 40 W of power to the circuit.

- [e] The total power dissipated by the resistors is given by

$$(i_{30\ \Omega})^2(30\ \Omega) + (i_{10\ \Omega})^2(10\ \Omega) = (2)^2(30\ \Omega) + (1)^2(10\ \Omega) = 120 + 10 = 130\text{ W}$$

Problems

P 2.1 [a] Yes, independent voltage sources can carry the 5 A current required by the connection; independent current source can support any voltage required by the connection, in this case 5 V, positive at the bottom.

[b] 20 V source: absorbing
 15 V source: developing (delivering)
 5 A source: developing (delivering)

$$\begin{aligned} \text{[c]} \quad P_{20V} &= (20)(5) = 100 \text{ W (abs)} \\ P_{15V} &= -(15)(5) = -75 \text{ W (dev/del)} \\ P_{5A} &= -(5)(5) = -25 \text{ W (dev/del)} \\ \sum P_{\text{abs}} &= \sum P_{\text{del}} = 100 \text{ W} \end{aligned}$$

[d] The interconnection is valid, but in this circuit the voltage drop across the 5 A current source is 35 V, positive at the top; 20 V source is developing (delivering), the 15 V source is developing (delivering), and the 5 A source is absorbing:

$$\begin{aligned} P_{20V} &= -(20)(5) = -100 \text{ W (dev/del)} \\ P_{15V} &= -(15)(5) = -75 \text{ W (dev/del)} \\ P_{5A} &= (35)(5) = 175 \text{ W (abs)} \\ \sum P_{\text{abs}} &= \sum P_{\text{del}} = 175 \text{ W} \end{aligned}$$

P 2.2 The interconnect is valid since the voltage sources can all carry 5 A of current supplied by the current source, and the current source can carry the voltage drop required by the interconnection. Note that the branch containing the 10 V, 40 V, and 5 A sources must have the same voltage drop as the branch containing the 50 V source, so the 5 A current source must have a voltage drop of 20 V, positive at the right. The voltages and currents are summarize in the circuit below:

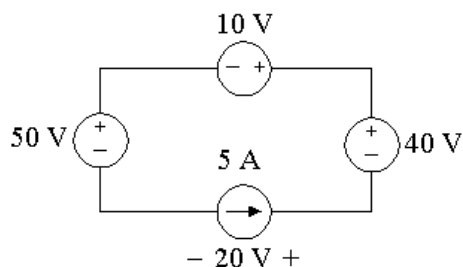

$$P_{50V} = (50)(5) = 250 \text{ W (abs)}$$

$$P_{10V} = (10)(5) = 50 \text{ W (abs)}$$

$$P_{40V} = -(40)(5) = -200 \text{ W (dev)}$$

$$P_{5A} = -(20)(5) = -100 \text{ W (dev)}$$

$$\sum P_{\text{dev}} = 300 \text{ W}$$

- P 2.3 The interconnection is valid. The 10 A current source has a voltage drop of 100 V, positive at the top, because the 100 V source supplies its voltage drop across a pair of terminals shared by the 10 A current source. The right hand branch of the circuit must also have a voltage drop of 100 V from the left terminal of the 40 V source to the bottom terminal of the 5 A current source, because this branch shares the same terminals as the 100 V source. This means that the voltage drop across the 5 A current source is 140 V, positive at the top. Also, the two voltage sources can carry the current required of the interconnection. This is summarized in the figure below:

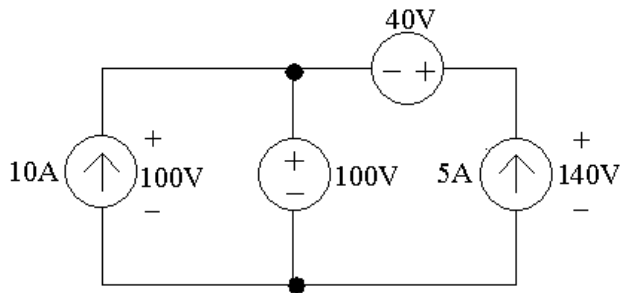

From the values of voltage and current in the figure, the power supplied by the current sources is calculated as follows:

$$P_{10A} = -(100)(10) = -1000 \text{ W (1000 W supplied)}$$

$$P_{5A} = -(140)(5) = -700 \text{ W (700 W supplied)}$$

$$\sum P_{\text{dev}} = 1700 \text{ W}$$

- P 2.4 The interconnection is not valid. Note that the 3 A and 4 A sources are both connected in the same branch of the circuit. A valid interconnection would require these two current sources to supply the same current in the same direction, which they do not.
- P 2.5 The interconnection is valid, since the voltage sources can carry the currents supplied by the 2 A and 3 A current sources, and the current sources can carry whatever voltage drop from the top node to the bottom node is required by the interconnection. In particular, note the the voltage drop between the top and bottom nodes in the right hand branch must be the same as the voltage drop between the top and bottom nodes in the left hand branch. In particular, this means that

$$-v_1 + 8 \text{ V} = 12 \text{ V} + v_2$$

Hence any combination of v_1 and v_2 such that $v_1 + v_2 = -4\text{ V}$ is a valid solution.

- P 2.6 [a] Because both current sources are in the same branch of the circuit, their values must be the same. Therefore,

$$\frac{v_1}{50} = 0.4 \quad \rightarrow \quad v_1 = 0.4(50) = 20\text{ V}$$

- [b] $p = v_1(0.4) = (20)(0.4) = 8\text{ W}$ (absorbed)

- P 2.7 [a] The voltage drop from the top node to the bottom node in this circuit must be the same for every path from the top to the bottom. Therefore, the voltages of the two voltage sources are equal:

$$-\alpha i_{\Delta} = 6$$

Also, the current i_{Δ} is in the same branch as the 15 mA current source, but in the opposite direction, so

$$i_{\Delta} = -0.015$$

Substituting,

$$-\alpha(-0.015) = 6 \quad \rightarrow \quad \alpha = \frac{6}{0.015} = 400$$

The interconnection is valid if $\alpha = 400\text{ V/A}$.

- [b] The voltage across the current source must equal the voltage across the 6 V source, since both are connected between the top and bottom nodes. Using the passive sign convention,

$$p = vi = (6)(0.015) = 0.09 = 90\text{ mW}$$

- [c] Since the power is positive, the current source is absorbing power.

- P 2.8 [a] Yes, each of the voltage sources can carry the current required by the interconnection, and each of the current sources can carry the voltage drop required by the interconnection. (Note that $i_1 = 50\text{ mA}$.)

- [b] No, because the voltage drop between the top terminal and the bottom terminal cannot be determined. For example, define v_1 , v_2 , and v_3 as shown:

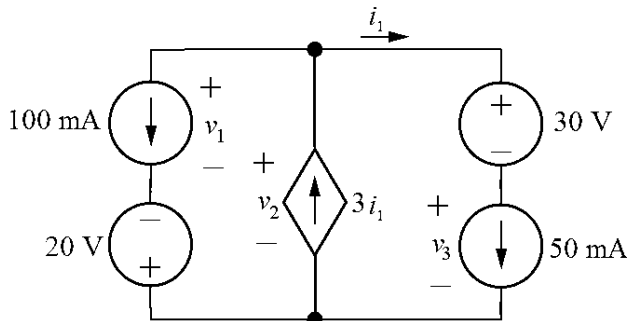

The voltage drop across the left branch, the center branch, and the right branch must be the same, since these branches are connected at the same two terminals. This requires that

$$v_1 - 20 = v_2 = v_3 + 30$$

But this equation has three unknown voltages, so the individual voltages cannot be determined, and thus the power of the sources cannot be determined.

- P 2.9 The interconnection is invalid. In the middle branch, the value of the current i_x must be 50 mA, since the 50 mA current source supplies current in this branch in the same direction as the current i_x . Therefore, the voltage supplied by the dependent voltage source in the right hand branch is $1800(0.05) = 90$ V. This gives a voltage drop from the top terminal to the bottom terminal in the right hand branch of $90 + 60 = 150$ V. But the voltage drop between these same terminals in the left hand branch is 30 V, due to the voltage source in that branch. Therefore, the interconnection is invalid.

P 2.10

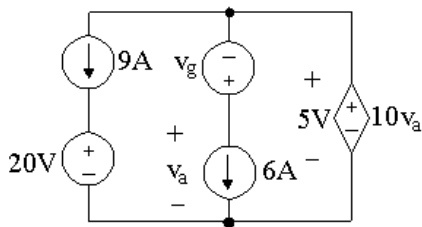

First, $10v_a = 5$ V, so $v_a = 0.5$ V. Then recognize that each of the three branches is connected between the same two nodes, so each of these branches must have the same voltage drop. The voltage drop across the middle branch is 5 V, and since $v_a = 0.5$ V, $v_g = 0.5 - 5 = -4.5$ V. Also, the voltage drop across the left branch is 5 V, so $20 + v_{9A} = 5$ V, and $v_{9A} = -15$ V, where v_{9A} is positive at the top. Note that the current through the 20 V source must be 9 A, flowing from top to bottom, and the current through the v_g is 6 A flowing from top to bottom. Let's find the power associated with the left and middle branches:

$$p_{9A} = (9)(-15) = -135 \text{ W}$$

$$p_{20V} = (9)(20) = 180 \text{ W}$$

$$p_{v_g} = -(6)(-4.5) = 27 \text{ W}$$

$$p_{6A} = (6)(0.5) = 3 \text{ W}$$

Since there is only one component left, we can find the total power:

$$p_{\text{total}} = -135 + 180 + 27 + 3 + p_{\text{ds}} = 75 + p_{\text{ds}} = 0$$

so p_{ds} must equal -75 W.

Therefore,

$$\sum P_{\text{dev}} = \sum P_{\text{abs}} = 210 \text{ W}$$

P 2.11 [a] Using the passive sign convention and Ohm's law,

$$v = Ri = (3000)(0.015) = 45 \text{ V}$$

[b] $P_R = \frac{v^2}{R} = \frac{45^2}{3000} = 0.675 = 675 \text{ mW}$

[c] Using the passive sign convention with the current direction reversed,

$$v = -Ri = -(3000)(0.015) = -45 \text{ V}$$

$$P_R = \frac{v^2}{R} = \frac{-45^2}{3000} = 0.675 = 675 \text{ mW}$$

P 2.12 [a] Using the passive sign convention and Ohm's law,

$$i = -\frac{v}{R} = -\frac{40}{2500} = -0.016 = -16 \text{ mA}$$

[b] $P_R = Ri^2 = (2500)(-0.016)^2 = 0.64 = 640 \text{ mW}$

[c] Using the passive sign convention with the voltage polarity reversed,

$$i = \frac{v}{R} = \frac{40}{2500} = 0.016 = 16 \text{ mA}$$

$$P_R = Ri^2 = (2500)(0.016)^2 = 0.64 = 640 \text{ mW}$$

P 2.13 [a]

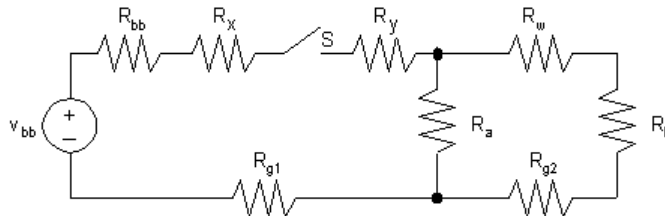

[b] V_{bb} = no-load voltage of battery

R_{bb} = internal resistance of battery

R_x = resistance of wire between battery and switch

R_y = resistance of wire between switch and lamp A

R_a = resistance of lamp A

R_b = resistance of lamp B

R_w = resistance of wire between lamp A and lamp B

R_{g1} = resistance of frame between battery and lamp A

R_{g2} = resistance of frame between lamp A and lamp B

S = switch

- P 2.14 Since we know the device is a resistor, we can use Ohm's law to calculate the resistance. From Fig. P2.14(a),

$$v = Ri \quad \text{so} \quad R = \frac{v}{i}$$

Using the values in the table of Fig. P2.14(b),

$$R = \frac{-7200}{-6} = \frac{-3600}{-3} = \frac{3600}{3} = \frac{7200}{6} = \frac{10,800}{9} = 1.2 \text{ k}\Omega$$

Note that this value is found in Appendix H.

- P 2.15 Since we know the device is a resistor, we can use the power equation. From Fig. P2.15(a),

$$p = vi = \frac{v^2}{R} \quad \text{so} \quad R = \frac{v^2}{p}$$

Using the values in the table of Fig. P2.13(b)

$$\begin{aligned} R &= \frac{(-8)^2}{640 \times 10^{-3}} = \frac{(-4)^2}{160 \times 10^{-3}} = \frac{(4)^2}{160 \times 10^{-3}} = \frac{(8)^2}{640 \times 10^{-3}} \\ &= \frac{(12)^2}{1440 \times 10^{-3}} = \frac{(16)^2}{2560 \times 10^{-3}} = 100 \Omega \end{aligned}$$

Note that this value is found in Appendix H.

- P 2.16 The resistor value is the ratio of the power to the square of the current:

$$R = \frac{p}{i^2}. \text{ Using the values for power and current in Fig. P2.16(b),}$$

$$\begin{aligned} \frac{8.25 \times 10^{-3}}{(0.5 \times 10^{-3})^2} &= \frac{33 \times 10^{-3}}{(1 \times 10^{-3})^2} = \frac{74.25 \times 10^{-3}}{(1.5 \times 10^{-3})^2} = \frac{132 \times 10^{-3}}{(2 \times 10^{-3})^2} \\ &= \frac{206.25 \times 10^{-3}}{(2.5 \times 10^{-3})^2} = \frac{297 \times 10^{-3}}{(3 \times 10^{-3})^2} = 33 \text{ k}\Omega \end{aligned}$$

Note that this is a value from Appendix H.

- P 2.17 Label the unknown resistor currents and voltages:

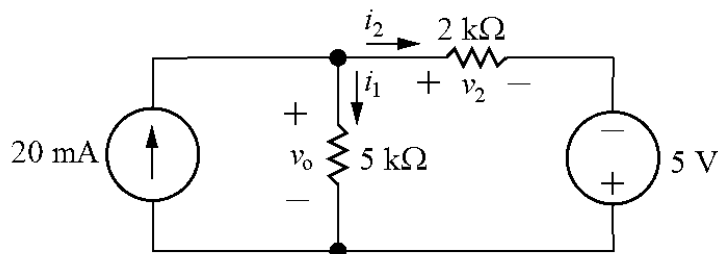

- [a] KCL at the top node: $0.02 = i_1 + i_2$
 KVL around the right loop: $-v_o + v_2 - 5 = 0$
 Use Ohm's law to write the resistor voltages in the previous equation in terms of the resistor currents:

$$-5000i_1 + 2000i_2 - 5 = 0 \quad \rightarrow \quad -5000i_1 + 2000i_2 = 5$$

Multiply the KCL equation by -2000 and add it to the KVL equation to eliminate i_2 :

$$-2000(i_1 + i_2) + (-5000i_1 + 2000i_2) = -2000(0.02) + 5 \quad \rightarrow \quad -7000i_1 = -35$$

Solving,

$$i_1 = \frac{-35}{-7000} = 0.005 = 5 \text{ mA}$$

Therefore,

$$v_o = Ri_1 = (5000)(0.005) = 25 \text{ V}$$

- [b] $p_{20\text{mA}} = -(0.02)v_o = -(0.02)(25) = -0.5 \text{ W}$

$$i_2 = 0.02 - i_1 = 0.02 - 0.005 = 0.015 \text{ A}$$

$$p_{5\text{V}} = -(5)i_2 = -(5)(0.015) = -0.075 \text{ W}$$

$$p_{5\text{k}} = 5000i_1^2 = 5000(0.005)^2 = 0.125 \text{ W}$$

$$p_{2\text{k}} = 2000i_2^2 = 2000(0.015)^2 = 0.45 \text{ W}$$

$$p_{\text{total}} = p_{20\text{mA}} + p_{5\text{V}} + p_{5\text{k}} + p_{2\text{k}} = -0.5 - 0.075 + 0.125 + 0.45 = 0$$

Thus the power in the circuit balances.

P 2.18 [a]

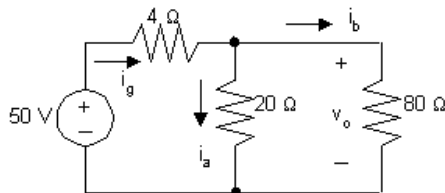

$$20i_a = 80i_b \quad i_g = i_a + i_b = 5i_b$$

$$i_a = 4i_b$$

$$50 = 4i_g + 80i_b = 20i_b + 80i_b = 100i_b$$

$$i_b = 0.5 \text{ A, therefore, } i_a = 2 \text{ A} \quad \text{and} \quad i_g = 2.5 \text{ A}$$

- [b] $i_b = 0.5 \text{ A}$

- [c] $v_o = 80i_b = 40 \text{ V}$

$$[d] \quad p_{4\Omega} = i_g^2(4) = 6.25(4) = 25 \text{ W}$$

$$p_{20\Omega} = i_a^2(20) = (4)(20) = 80 \text{ W}$$

$$p_{80\Omega} = i_b^2(80) = 0.25(80) = 20 \text{ W}$$

$$[e] \quad p_{50\text{V}} \text{ (delivered)} = 50i_g = 125 \text{ W}$$

Check:

$$\sum P_{\text{dis}} = 25 + 80 + 20 = 125 \text{ W}$$

$$\sum P_{\text{del}} = 125 \text{ W}$$

P 2.19

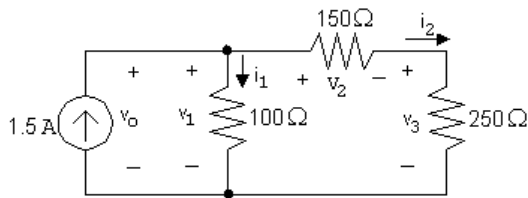

[a] Write a KCL equation at the top node:

$$-1.5 + i_1 + i_2 = 0 \quad \text{so} \quad i_1 + i_2 = 1.5$$

Write a KVL equation around the right loop:

$$-v_1 + v_2 + v_3 = 0$$

From Ohm's law,

$$v_1 = 100i_1, \quad v_2 = 150i_2, \quad v_3 = 250i_2$$

Substituting,

$$-100i_1 + 150i_2 + 250i_2 = 0 \quad \text{so} \quad -100i_1 + 400i_2 = 0$$

Solving the two equations for i_1 and i_2 simultaneously,

$$i_1 = 1.2 \text{ A} \quad \text{and} \quad i_2 = 0.3 \text{ A}$$

[b] Write a KVL equation clockwise around the left loop:

$$-v_o + v_1 = 0 \quad \text{but} \quad v_1 = 100i_1 = 100(1.2) = 120 \text{ V}$$

$$\text{So} \quad v_o = v_1 = 120 \text{ V}$$

[c] Calculate power using $p = vi$ for the source and $p = Ri^2$ for the resistors:

$$p_{\text{source}} = -v_o(1.5) = -(120)(1.5) = -180 \text{ W}$$

$$p_{100\Omega} = 1.2^2(100) = 144 \text{ W}$$

$$p_{150\Omega} = 0.3^2(150) = 13.5 \text{ W}$$

$$p_{250\Omega} = 0.3^2(250) = 22.5 \text{ W}$$

$$\sum P_{\text{dev}} = 180 \text{ W} \quad \sum P_{\text{abs}} = 144 + 13.5 + 22.5 = 180 \text{ W}$$

P 2.20 Label the unknown resistor voltages and currents:

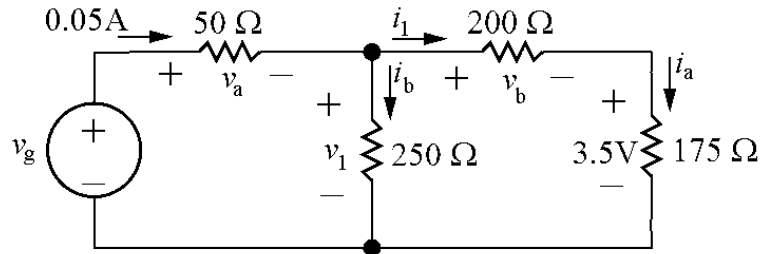

[a] $i_a = \frac{3.5}{175} = 0.02 \text{ A}$ (Ohm's law)

$i_1 = i_a = 0.02 \text{ A}$ (KCL)

[b] $v_b = 200i_1 = 200(0.02) = 4 \text{ V}$ (Ohm's law)

$-v_1 + v_b + 3.5 = 0$ so $v_1 = 3.5 + v_b = 3.5 + 4 = 7.5 \text{ V}$ (KVL)

[c] $v_a = 0.05(50) = 2.5 \text{ V}$ (Ohm's law)

$-v_g + v_a + v_1 = 0$ so $v_g = v_a + v_1 = 2.5 + 7.5 = 10 \text{ V}$ (KVL)

[d] $p_g = v_g(0.05) = 10(0.05) = 0.5 \text{ W}$

P 2.21 [a] Use KVL for the right loop to calculate the voltage drop across the right-hand branch v_o . This is also the voltage drop across the middle branch, so once v_o is known, use Ohm's law to calculate i_o :

$v_o = 1000i_a + 4000i_a + 3000i_a = 8000i_a = 8000(0.002) = 16 \text{ V}$

$16 = 2000i_o$

$i_o = \frac{16}{2000} = 8 \text{ mA}$

[b] KCL at the top node: $i_g = i_a + i_o = 0.002 + 0.008 = 0.010 \text{ A} = 10 \text{ mA}$.

[c] The voltage drop across the source is v_o , seen by writing a KVL equation for the left loop. Thus,

$p_g = -v_o i_g = -(16)(0.01) = -0.160 \text{ W} = -160 \text{ mW}$.

Thus the source delivers 160 mW.

P 2.22 [a]

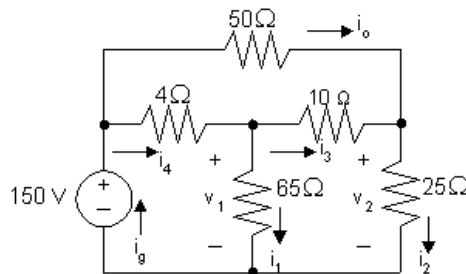

$v_2 = 150 - 50(1) = 100 \text{ V}$

$$i_2 = \frac{v_2}{25} = 4\text{A}$$

$$i_3 + 1 = i_2, \quad i_3 = 4 - 1 = 3\text{A}$$

$$v_1 = 10i_3 + 25i_2 = 10(3) + 25(4) = 130\text{V}$$

$$i_1 = \frac{v_1}{65} = \frac{130}{65} = 2\text{A}$$

Note also that

$$i_4 = i_1 + i_3 = 2 + 3 = 5\text{A}$$

$$i_g = i_4 + i_o = 5 + 1 = 6\text{A}$$

$$[\text{b}] \quad p_{4\Omega} = 5^2(4) = 100\text{ W}$$

$$p_{50\Omega} = 1^2(50) = 50\text{ W}$$

$$p_{65\Omega} = 2^2(65) = 260\text{ W}$$

$$p_{10\Omega} = 3^2(10) = 90\text{ W}$$

$$p_{25\Omega} = 4^2(25) = 400\text{ W}$$

$$[\text{c}] \quad \sum P_{\text{dis}} = 100 + 50 + 260 + 90 + 400 = 900\text{ W}$$

$$P_{\text{dev}} = 150i_g = 150(6) = 900\text{ W}$$

P 2.23 Label all unknown resistor voltages and currents:

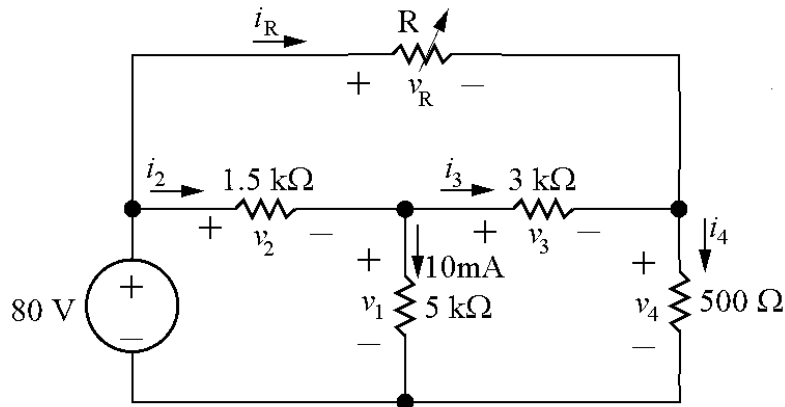

$$\text{Ohm's law for } 5\text{ k}\Omega \text{ resistor: } v_1 = (0.01)(5000) = 50\text{ V}$$

$$\text{KVL for lower left loop: } -80 + v_2 + 50 = 0 \rightarrow v_2 = 80 - 50 = 30\text{ V}$$

$$\text{Ohm's law for } 1.5\text{ k}\Omega \text{ resistor: } i_2 = v_2/1500 = 30/1500 = 20\text{ mA}$$

KCL at center node:

$$i_2 = i_3 + 0.01 \rightarrow i_3 = i_2 - 0.01 = 0.02 - 0.01 = 0.01 = 10\text{ mA}$$

$$\text{Ohm's law for } 3\text{ k}\Omega \text{ resistor } v_3 = 3000i_3 = 3000(0.01) = 30\text{ V}$$

KVL for lower right loop:

$$-v_1 + v_3 + v_4 = 0 \rightarrow v_4 = v_1 - v_3 = 50 - 30 = 20\text{ V}$$

Ohm's law for $500\ \Omega$ resistor: $i_4 = v_4/500 = 20/500 = 0.04 = 40\ \text{mA}$

KCL for right node:

$$i_3 + i_R = i_4 \rightarrow i_R = i_4 - i_3 = 0.04 - 0.01 = 0.03 = 30\ \text{mA}$$

KVL for outer loop:

$$-80 + v_R + v_4 = 0 \rightarrow v_R = 80 - v_4 = 80 - 20 = 60\ \text{V}$$

Therefore,

$$R = \frac{v_R}{i_R} = \frac{60}{0.03} = 2000 = 2\ \text{k}\Omega$$

P 2.24 [a]

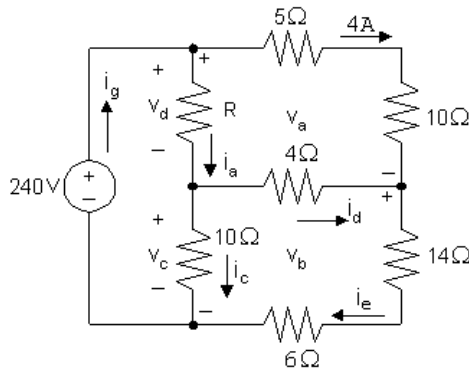

$$v_a = (5 + 10)(4) = 60\ \text{V}$$

$$-240 + v_a + v_b = 0 \quad \text{so} \quad v_b = 240 - v_a = 240 - 60 = 180\ \text{V}$$

$$i_e = v_b/(14 + 6) = 180/20 = 9\ \text{A}$$

$$i_d = i_e - 4 = 9 - 4 = 5\ \text{A}$$

$$v_c = 4i_d + v_b = 4(5) + 180 = 200\ \text{V}$$

$$i_c = v_c/10 = 200/10 = 20\ \text{A}$$

$$v_d = 240 - v_c = 240 - 200 = 40\ \text{V}$$

$$i_a = i_d + i_c = 5 + 20 = 25\ \text{A}$$

$$R = v_d/i_a = 40/25 = 1.6\ \Omega$$

[b] $i_g = i_a + 4 = 25 + 4 = 29\ \text{A}$

$$p_g \text{ (supplied)} = (240)(29) = 6960\ \text{W}$$

P 2.25 [a]

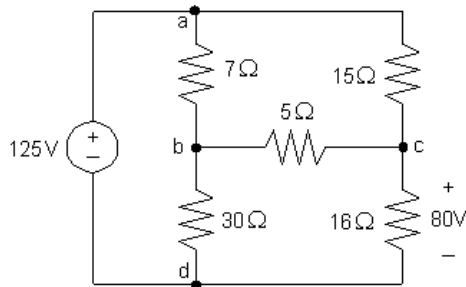

$$i_{cd} = 80/16 = 5\ \text{A}$$

$$v_{ac} = 125 - 80 = 45 \quad \text{so} \quad i_{ac} = 45/15 = 3\ \text{A}$$

[b] Calculate power using the formula $p = Ri^2$:

$$\begin{aligned}
 p_{9\Omega} &= (9)(2)^2 = 36 \text{ W}; & p_{11\Omega} &= (11)(2)^2 = 44 \text{ W} \\
 p_{10\Omega} &= (10)(2)^2 = 40 \text{ W}; & p_{5\Omega} &= (5)(6)^2 = 180 \text{ W} \\
 p_{30\Omega} &= (30)(3)^2 = 270 \text{ W}; & p_{4\Omega} &= (4)(5)^2 = 100 \text{ W} \\
 p_{16\Omega} &= (16)(5)^2 = 400 \text{ W}; & p_{15\Omega} &= (15)(4)^2 = 240 \text{ W}
 \end{aligned}$$

[c] $v_g = 190 \text{ V}$

[d] Sum the power dissipated by the resistors:

$$\sum p_{\text{diss}} = 36 + 44 + 40 + 180 + 270 + 100 + 400 + 240 = 1310 \text{ W}$$

The power associated with the sources is

$$\begin{aligned}
 p_{\text{volt-source}} &= (100)(4) = 400 \text{ W} \\
 p_{\text{curr-source}} &= v_g i_g = (190)(-9) = -1710 \text{ W}
 \end{aligned}$$

Thus the total power dissipated is $1310 + 400 = 1710 \text{ W}$ and the total power developed is 1710 W , so the power balances.

P 2.27 [a] Start by calculating the voltage drops due to the currents i_1 and i_2 . Then use KVL to calculate the voltage drop across and 35Ω resistor, and Ohm's law to find the current in the 35Ω resistor. Finally, KCL at each of the middle three nodes yields the currents in the two sources and the current in the middle 2Ω resistor. These calculations are summarized in the figure below:

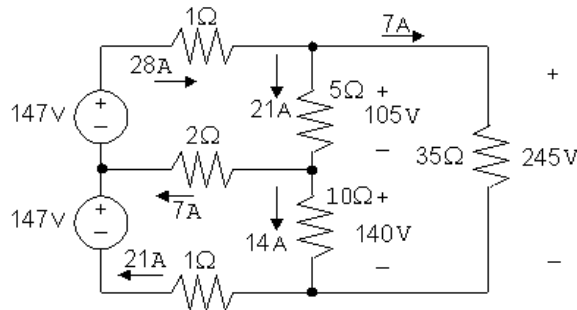

$$p_{147(\text{top})} = -(147)(28) = -4116 \text{ W}$$

$$p_{147(\text{bottom})} = -(147)(21) = -3087 \text{ W}$$

Therefore the top source supplies 4116 W of power and the bottom source supplies 3087 W of power.

[b]

$$\begin{aligned}
 \sum P_{\text{dis}} &= (28)^2(1) + (7)^2(2) + (21)^2(1) + (21)^2(5) + (14)^2(10) + (7)^2(35) \\
 &= 784 + 98 + 441 + 2205 + 1960 + 1715 = 7203 \text{ W}
 \end{aligned}$$

$$\sum P_{\text{sup}} = 4116 + 3087 = 7203 \text{ W}$$

Therefore, $\sum P_{\text{dis}} = \sum P_{\text{sup}} = 7203 \text{ W}$

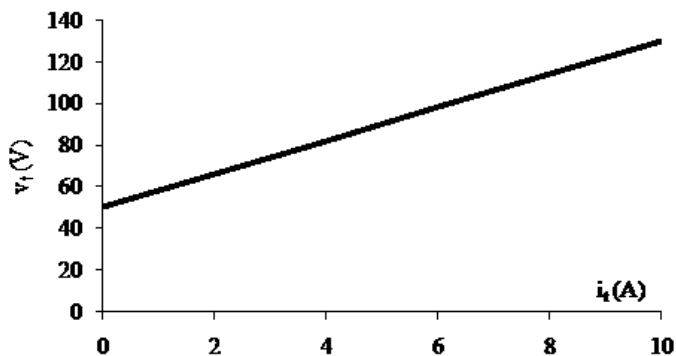
P 2.28 [a] Plot the $v - i$ characteristic

From the plot:

$$R = \frac{\Delta v}{\Delta i} = \frac{(130 - 50)}{(10 - 0)} = 8 \Omega$$

When $i_t = 0$, $v_t = 50$ V; therefore the ideal voltage source has a voltage of 50 V.

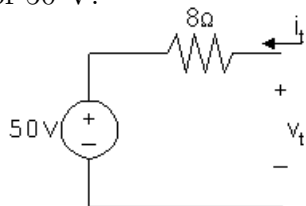

[b]

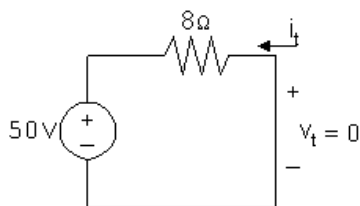

$$\text{When } v_t = 0, \quad i_t = \frac{-50}{8} = -6.25 \text{ A}$$

Note that this result can also be obtained by extrapolating the $v - i$ characteristic to $v_t = 0$.

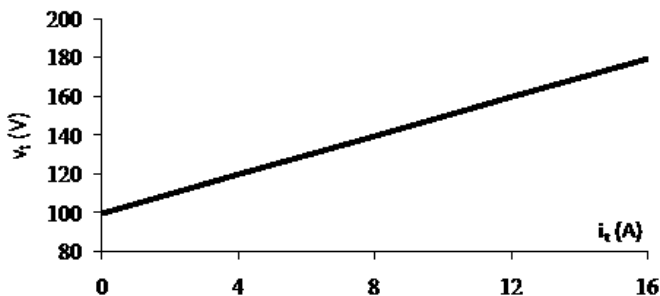
P 2.29 [a] Plot the $v - i$ characteristic:

From the plot:

$$R = \frac{\Delta v}{\Delta i} = \frac{(180 - 100)}{(16 - 0)} = 5 \Omega$$

When $i_t = 0$, $v_t = 100$ V; therefore the ideal current source must have a current of $100/5 = 20$ A

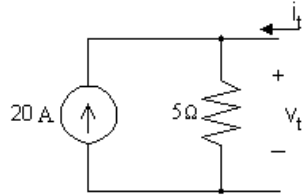

[b] We attach a 20Ω resistor to the device model developed in part (a):

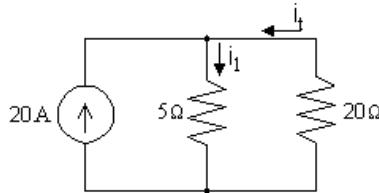

Write a KCL equation at the top node:

$$20 + i_t = i_1$$

Write a KVL equation for the right loop, in the direction of the two currents, using Ohm's law:

$$5i_1 + 20i_t = 0$$

Combining the two equations and solving,

$$5(20 + i_t) + 20i_t = 0 \quad \text{so} \quad 25i_t = -100; \quad \text{thus} \quad i_t = -4 \text{ A}$$

Now calculate the power dissipated by the resistor:

$$p_{20 \Omega} = 20i_t^2 = 20(-4)^2 = 320 \text{ W}$$

P 2.30 [a]

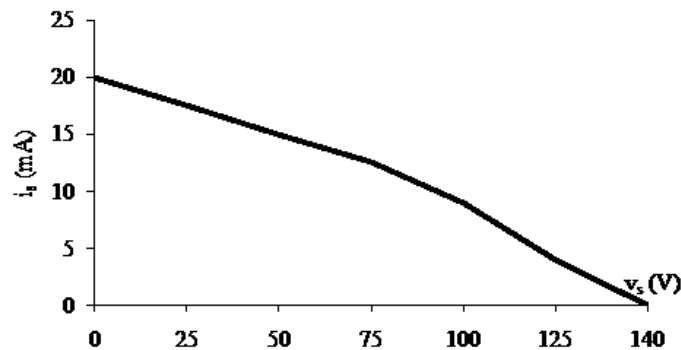

[b] $\Delta v = 25\text{V}; \quad \Delta i = 2.5 \text{ mA}; \quad R = \frac{\Delta v}{\Delta i} = 10 \text{ k}\Omega$

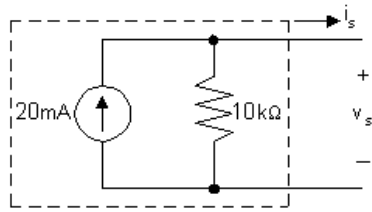

[c] $10,000i_1 = 2500i_s, \quad i_1 = 0.25i_s$
 $0.02 = i_1 + i_s = 1.25i_s, \quad i_s = 16 \text{ mA}$

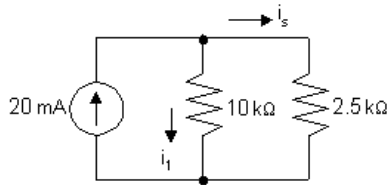

[d] $v_s(\text{open circuit}) = (20 \times 10^{-3})(10 \times 10^3) = 200 \text{ V}$

[e] The open circuit voltage can be found in the table of values (or from the plot) as the value of the voltage v_s when the current $i_s = 0$. Thus, $v_s(\text{open circuit}) = 140 \text{ V}$ (from the table)

[f] Linear model cannot predict the nonlinear behavior of the practical current source.

P 2.31 [a] Begin by constructing a plot of voltage versus current:

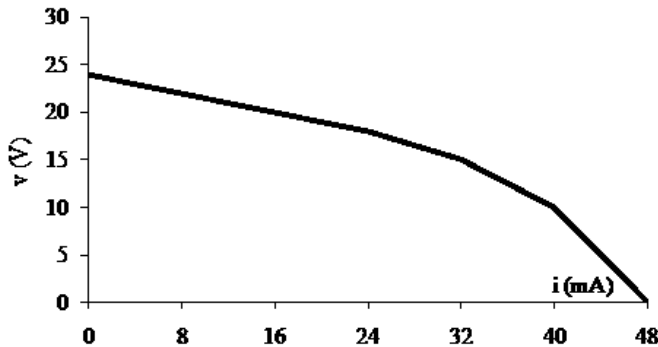

[b] Since the plot is linear for $0 \leq i_s \leq 24 \text{ mA}$ and since $R = \Delta v / \Delta i$, we can calculate R from the plotted values as follows:

$$R = \frac{\Delta v}{\Delta i} = \frac{24 - 18}{0.024 - 0} = \frac{6}{0.024} = 250 \Omega$$

We can determine the value of the ideal voltage source by considering the value of v_s when $i_s = 0$. When there is no current, there is no voltage drop across the resistor, so all of the voltage drop at the output is due to the voltage source. Thus the value of the voltage source must be 24 V.

The model, valid for $0 \leq i_s \leq 24 \text{ mA}$, is shown below:

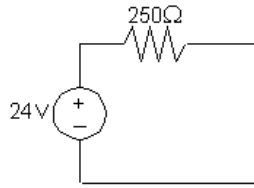

[c] The circuit is shown below:

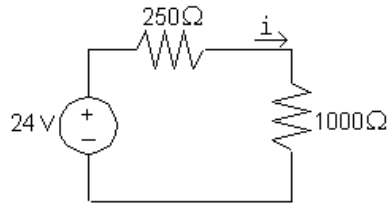

Write a KVL equation in the clockwise direction, starting below the voltage source. Use Ohm's law to express the voltage drop across the resistors in terms of the current i :

$$-24 \text{ V} + 250i + 1000i = 0 \quad \text{so} \quad 1250i = 24 \text{ V}$$

$$\text{Thus,} \quad i = \frac{24 \text{ V}}{1250 \Omega} = 19.2 \text{ mA}$$

[d] The circuit is shown below:

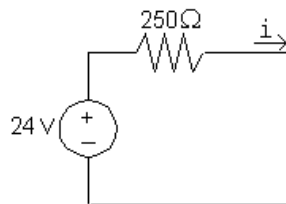

Write a KVL equation in the clockwise direction, starting below the voltage source. Use Ohm's law to express the voltage drop across the resistors in terms of the current i :

$$-24 \text{ V} + 250i = 0 \quad \text{so} \quad 250i = 24 \text{ V}$$

$$\text{Thus,} \quad i = \frac{24 \text{ V}}{250 \Omega} = 96 \text{ mA}$$

[e] The short circuit current can be found in the table of values (or from the plot) as the value of the current i_s when the voltage $v_s = 0$. Thus,

$$i_{sc} = 48 \text{ mA} \quad (\text{from table})$$

[f] The plot of voltage versus current constructed in part (a) is not linear (it is piecewise linear, but not linear for all values of i_s). Since the proposed circuit model is a linear model, it cannot be used to predict the nonlinear behavior exhibited by the plotted data.

P 2.32 Label unknown voltage and current:

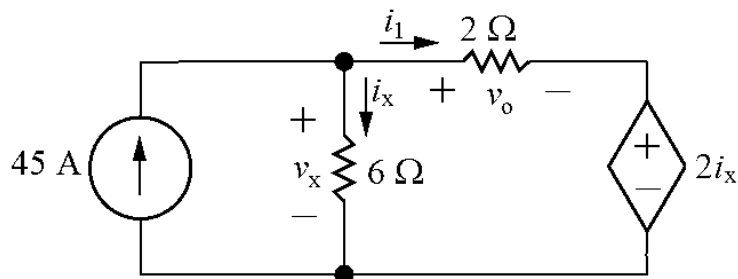

$$-v_x + v_o + 2i_x = 0 \quad (\text{KVL})$$

$$v_x = 6i_x \quad (\text{Ohm's law})$$

Therefore

$$-6i_x + v_o + 2i_x = 0 \quad \text{so} \quad v_o = 4i_x$$

Thus

$$i_x = \frac{v_o}{4}$$

Also,

$$i_1 = \frac{v_o}{2} \quad (\text{Ohm's law})$$

$$45 = i_x + i_1 \quad (\text{KCL})$$

Substituting for the currents i_x and i_1 :

$$45 = \frac{v_o}{4} + \frac{v_o}{2} = \frac{3v_o}{4}$$

Thus

$$v_o = 45 \left(\frac{4}{3} \right) = 60 \text{ V}$$

The only two circuit elements that could supply power are the two sources, so calculate the power for each source:

$$v_x = 6i_x = 6 \frac{v_o}{4} = 6(60/4) = 90 \text{ V}$$

$$p_{45\text{V}} = -45v_x = -45(90) = -4050 \text{ W}$$

$$p_{\text{d.s.}} = (2i_x)i_1 = 2(v_o/4)(v_o/2) = 2(60/4)(60/2) = 900 \text{ W}$$

Only the independent voltage source is supplying power, so the total power supplied is 4050 W.

P 2.33 Label unknown current:

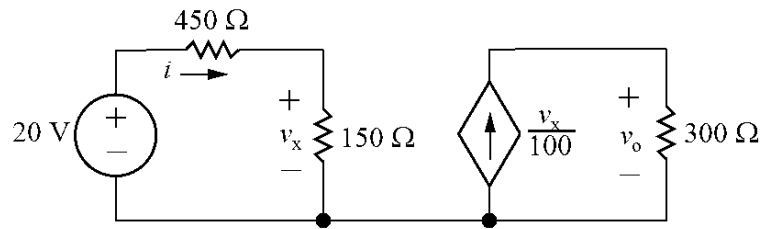

$$-20 + 450i + 150i = 0 \quad (\text{KVL and Ohm's law})$$

$$\text{so } 600i = 20 \rightarrow i = 33.33 \text{ mA}$$

$$v_x = 150i = 150(0.0333) = 5 \text{ V} \quad (\text{Ohm's law})$$

$$v_o = 300 \left(\frac{v_x}{100} \right) = 300(5/100) = 15 \text{ V} \quad (\text{Ohm's law})$$

Calculate the power for all components:

$$p_{20\text{V}} = -20i = -20(0.0333) = -0.667 \text{ W}$$

$$p_{\text{d.s.}} = -v_o \left(\frac{v_x}{100} \right) = -(15)(5/100) = -0.75 \text{ W}$$

$$p_{450} = 450i^2 = 450(0.033)^2 = 0.5 \text{ W}$$

$$p_{150} = 150i^2 = 150(0.033)^2 = 0.1667 \text{ W}$$

$$p_{300} = \frac{v_o^2}{300} = \frac{15^2}{300} = 0.75 \text{ W}$$

Thus the total power absorbed is

$$p_{\text{abs}} = 0.5 + 0.1667 + 0.75 = 1.4167 \text{ W}$$

P 2.34 The circuit:

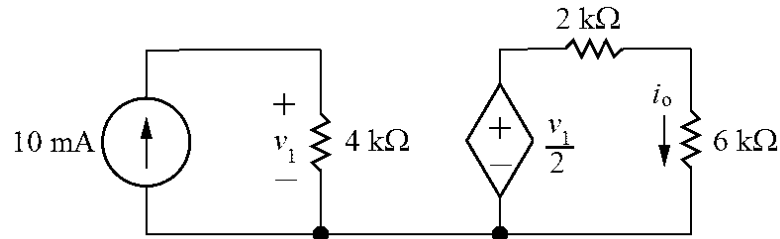

$$v_1 = (4000)(0.01) = 40 \text{ V} \quad (\text{Ohm's law})$$

$$\frac{v_1}{2} = 2000i_o + 6000i_o = 8000i_o \quad (\text{KVL})$$

Thus,

$$i_o = \frac{v_1/2}{8000} = \frac{40/2}{8000} = 0.0025 = 2.5 \text{ mA}$$

Calculate the power for all components:

$$p_{10\text{mA}} = -(0.01)v_1 = -(0.01)(40) = -0.4 \text{ W}$$

$$p_{\text{d.s.}} = -(v_1/2)i_o = -(40/2)(2.5 \times 10^{-3}) = -0.05 \text{ W}$$

$$p_{4\text{k}} = \frac{v_1^2}{4000} = \frac{40^2}{4000} = 0.4 \text{ W}$$

$$p_{2\text{k}} = 2000i_o^2 = 2000(2.5 \times 10^{-3})^2 = 0.0125 \text{ W}$$

$$p_{6\text{k}} = 6000i_o^2 = 6000(2.5 \times 10^{-3})^2 = 0.0375 \text{ W}$$

Therefore,

$$p_{\text{total}} = -0.4 - 0.05 + 0.4 + 0.0125 + 0.0375 = 0$$

Thus the power in the circuit balances.

P 2.35 [a] $i_o = 0$ because no current can exist in a single conductor connecting two parts of a circuit.

[b]

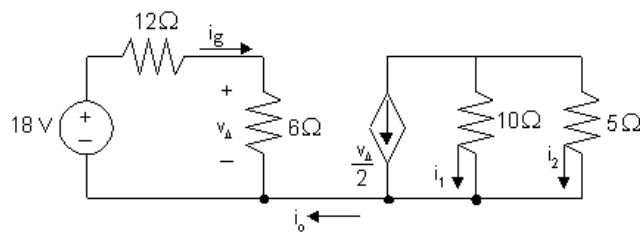

$$18 = (12 + 6)i_g \quad i_g = 1 \text{ A}$$

$$v_\Delta = 6i_g = 6\text{V} \quad v_\Delta/2 = 3 \text{ A}$$

$$10i_1 = 5i_2, \text{ so } i_1 + 2i_1 = -3 \text{ A; therefore, } i_1 = -1 \text{ A}$$

[c] $i_2 = 2i_1 = -2 \text{ A}$.

P 2.36 [a] $-50 - 20i_\sigma + 18i_\Delta = 0$

$$-18i_\Delta + 5i_\sigma + 40i_\sigma = 0 \quad \text{so} \quad 18i_\Delta = 45i_\sigma$$

Therefore, $-50 - 20i_\sigma + 45i_\sigma = 0$, so $i_\sigma = 2 \text{ A}$

$$18i_\Delta = 45i_\sigma = 90; \text{ so } i_\Delta = 5 \text{ A}$$

$$v_o = 40i_\sigma = 80 \text{ V}$$

[b] i_g = current out of the positive terminal of the 50 V source
 v_d = voltage drop across the $8i_\Delta$ source

$$i_g = i_\Delta + i_\sigma + 8i_\Delta = 9i_\Delta + i_\sigma = 47 \text{ A}$$

$$v_d = 80 - 20 = 60 \text{ V}$$

$$\sum P_{\text{gen}} = 50i_g + 20i_\sigma i_g = 50(47) + 20(2)(47) = 4230 \text{ W}$$

$$\begin{aligned} \sum P_{\text{diss}} &= 18i_\Delta^2 + 5i_\sigma(i_g - i_\Delta) + 40i_\sigma^2 + 8i_\Delta v_d + 8i_\Delta(20) \\ &= (18)(25) + 10(47 - 5) + 4(40) + 40(60) + 40(20) \\ &= 4230 \text{ W}; \text{ Therefore,} \end{aligned}$$

$$\sum P_{\text{gen}} = \sum P_{\text{diss}} = 4230 \text{ W}$$

P 2.37 $40i_2 + \frac{5}{40} + \frac{5}{10} = 0$; $i_2 = -15.625 \text{ mA}$

$$v_1 = 80i_2 = -1.25 \text{ V}$$

$$25i_1 + \frac{(-1.25)}{20} + (-0.015625) = 0; \quad i_1 = 3.125 \text{ mA}$$

$$v_g = 60i_1 + 260i_1 = 320i_1$$

Therefore, $v_g = 1 \text{ V}$.

P 2.38 $i_E - i_B - i_C = 0$

$$i_C = \beta i_B \quad \text{therefore } i_E = (1 + \beta)i_B$$

$$i_2 = -i_B + i_1$$

$$V_o + i_E R_E - (i_1 - i_B)R_2 = 0$$

$$-i_1 R_1 + V_{CC} - (i_1 - i_B)R_2 = 0 \quad \text{or} \quad i_1 = \frac{V_{CC} + i_B R_2}{R_1 + R_2}$$

$$V_o + i_E R_E + i_B R_2 - \frac{V_{CC} + i_B R_2}{R_1 + R_2} R_2 = 0$$

Now replace i_E by $(1 + \beta)i_B$ and solve for i_B . Thus

$$i_B = \frac{[V_{CC} R_2 / (R_1 + R_2)] - V_o}{(1 + \beta) R_E + R_1 R_2 / (R_1 + R_2)}$$

P 2.39 Here is Equation 2.25:

$$i_B = \frac{(V_{CC} R_2) / (R_1 + R_2) - V_o}{(R_1 R_2) / (R_1 + R_2) + (1 + \beta) R_E}$$

$$\frac{V_{CC} R_2}{R_1 + R_2} = \frac{(10)(60,000)}{100,000} = 6\text{V}$$

$$\frac{R_1 R_2}{R_1 + R_2} = \frac{(40,000)(60,000)}{100,000} = 24 \text{ k}\Omega$$

$$i_B = \frac{6 - 0.6}{24,000 + 50(120)} = \frac{5.4}{30,000} = 0.18 \text{ mA}$$

$$i_C = \beta i_B = (49)(0.18) = 8.82 \text{ mA}$$

$$i_E = i_C + i_B = 8.82 + 0.18 = 9 \text{ mA}$$

$$v_{3d} = (0.009)(120) = 1.08\text{V}$$

$$v_{bd} = V_o + v_{3d} = 1.68\text{V}$$

$$i_2 = \frac{v_{bd}}{R_2} = \frac{1.68}{60,000} = 28 \mu\text{A}$$

$$i_1 = i_2 + i_B = 28 + 180 = 208 \mu\text{A}$$

$$v_{ab} = 40,000(208 \times 10^{-6}) = 8.32\text{V}$$

$$i_{CC} = i_C + i_1 = 8.82 + 0.208 = 9.028 \text{ mA}$$

$$v_{13} + (8.82 \times 10^{-3})(750) + 1.08 = 10 \text{ V}$$

$$v_{13} = 2.305 \text{ V}$$

P 2.40 [a]

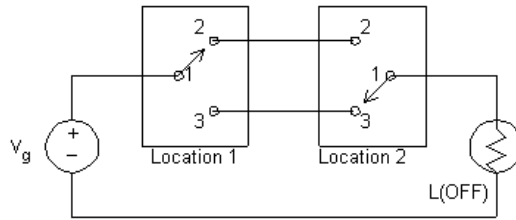

[b]

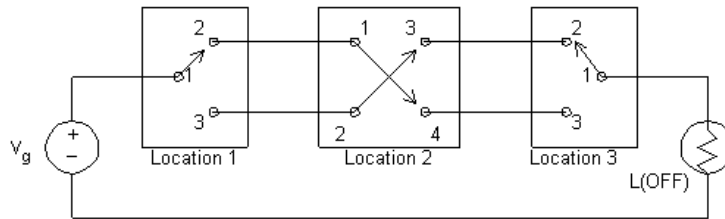

P 2.41 Each radiator is modeled as a $48\ \Omega$ resistor:

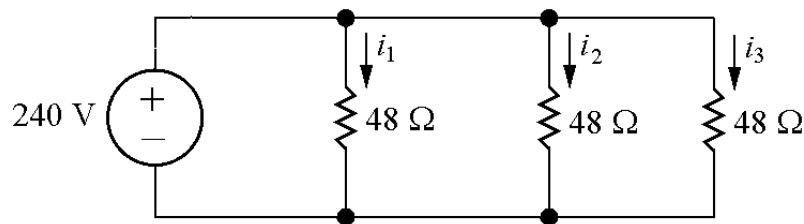

Write a KVL equation for each of the three loops:

$$-240 + 48i_1 = 0 \quad \rightarrow \quad i_1 = \frac{240}{48} = 5\text{ A}$$

$$-48i_1 + 48i_2 = 0 \quad \rightarrow \quad i_2 = i_1 = 5\text{ A}$$

$$-48i_2 + 48i_3 = 0 \quad \rightarrow \quad i_3 = i_2 = 5\text{ A}$$

Therefore, the current through each radiator is 5 A and the power for each radiator is

$$p_{\text{rad}} = Ri^2 = 48(5)^2 = 1200\text{ W}$$

There are three radiators, so the total power for this heating system is

$$p_{\text{total}} = 3p_{\text{rad}} = 3(1200) = 3600\text{ W}$$

P 2.42 Each radiator is modeled as a $48\ \Omega$ resistor:

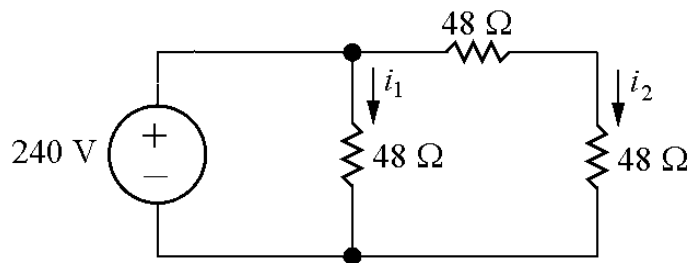

Write a KVL equation for the left and right loops:

$$-240 + 48i_1 = 0 \quad \rightarrow \quad i_1 = \frac{240}{48} = 5\text{ A}$$

$$-48i_1 + 48i_2 + 48i_2 = 0 \quad \rightarrow \quad i_2 = \frac{i_1}{2} = \frac{5}{2} = 2.5\text{ A}$$

The power for the center radiator is

$$p_{\text{cen}} = 48i_1^2 = 48(5)^2 = 1200\text{ W}$$

The power for each of the radiators on the right is

$$p_{\text{right}} = 48i_2^2 = 48(2.5)^2 = 300\text{ W}$$

Thus the total power for this heating system is

$$p_{\text{total}} = p_{\text{cen}} + 2p_{\text{right}} = 1200 + 2(300) = 1800\text{ W}$$

The center radiator produces 1200 W, just like the three radiators in Problem 2.41. But the other two radiators produce only 300 W each, which is 1/4th of the power of the radiators in Problem 2.41. The total power of this configuration is 1/2 of the total power in Fig. 2.41.

P 2.43 Each radiator is modeled as a $48\ \Omega$ resistor:

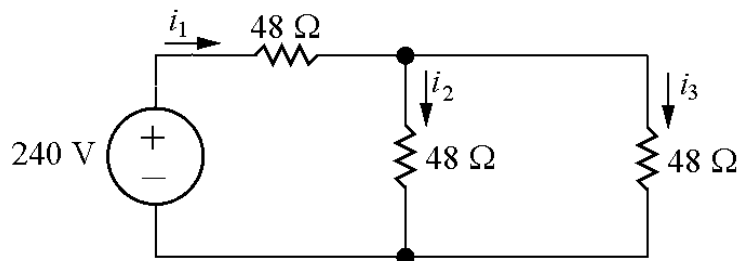

Write a KVL equation for the left and right loops:

$$-240 + 48i_1 + 48i_2 = 0$$

$$-48i_2 + 48i_3 = 0 \quad \rightarrow \quad i_2 = i_3$$

Write a KCL equation at the top node:

$$i_1 = i_2 + i_3 \quad \rightarrow \quad i_1 = i_2 + i_2 = 2i_2$$

Substituting into the first KVL equation gives

$$-240 + 48(2i_2) + 48i_2 = 0 \quad \rightarrow \quad i_2 = \frac{240}{3(48)} = 1.67 \text{ A}$$

Solve for the currents i_1 and i_3 :

$$i_3 = i_2 = 1.67 \text{ A}; \quad i_1 = 2i_2 = 2(1.67) = 3.33 \text{ A}$$

Calculate the power for each radiator using the current for each radiator:

$$p_{\text{left}} = 48i_1^2 = 48(3.33)^2 = 533.33 \text{ W}$$

$$p_{\text{middle}} = p_{\text{right}} = 48i_2^2 = 48(1.67)^2 = 133.33 \text{ W}$$

Thus the total power for this heating system is

$$p_{\text{total}} = p_{\text{left}} + p_{\text{middle}} + p_{\text{right}} = 533.33 + 133.33 + 133.33 = 800 \text{ W}$$

All radiators in this configuration have much less power than their counterparts in Fig. 2.41. The total power for this configuration is only 22.2% of the total power for the heating system in Fig. 2.41.

P 2.44 Each radiator is modeled as a 48Ω resistor:

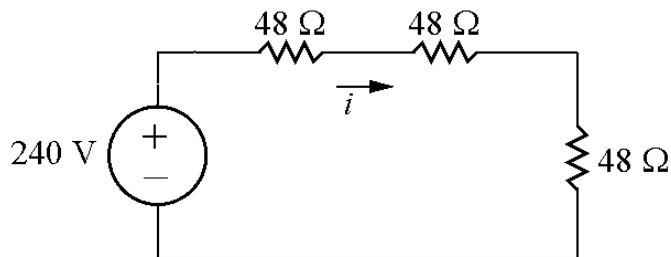

Write a KVL equation for this loop:

$$-240 + 48i + 48i + 48i = 0 \quad \rightarrow \quad i = \frac{240}{3(48)} = 1.67 \text{ A}$$

Calculate the power for each radiator:

$$p_{\text{rad}} = 48i^2 = 48(1.67)^2 = 133.33 \text{ W}$$

Calculate the total power for this heating system:

$$p_{\text{total}} = 3p_{\text{rad}} = 3(133.33) = 400 \text{ W}$$

Each radiator has much less power than the radiators in Fig. 2.41, and the total power of this configuration is just 1/9th of the total power in Fig. 2.41.