

Chapter 2

First-Order Differential Equations

2.1 Solution Curves Without a Solution

1.

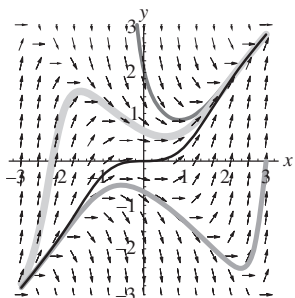

2.

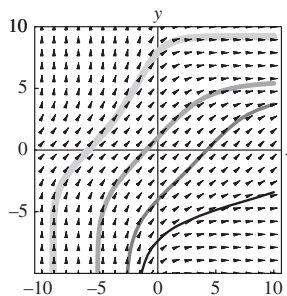

3.

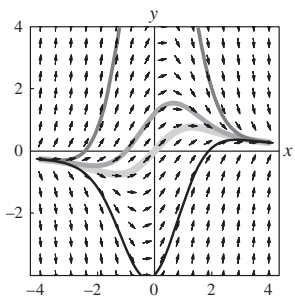

4.

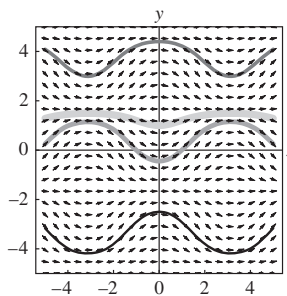

5.

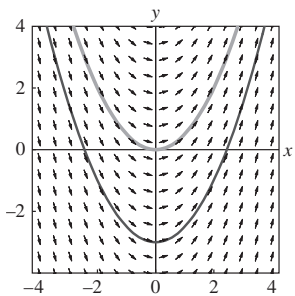

6.

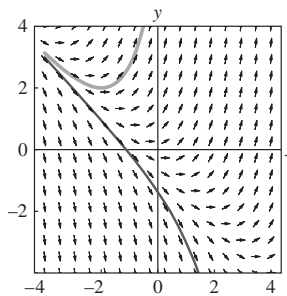

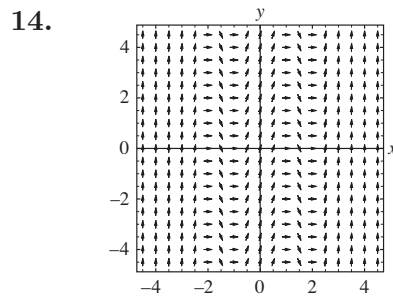
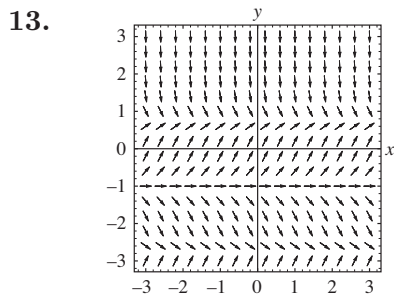
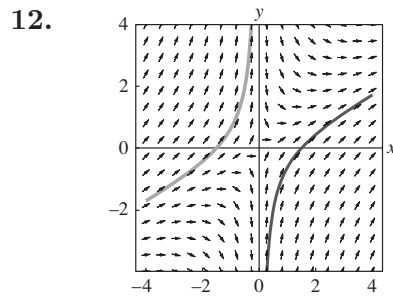
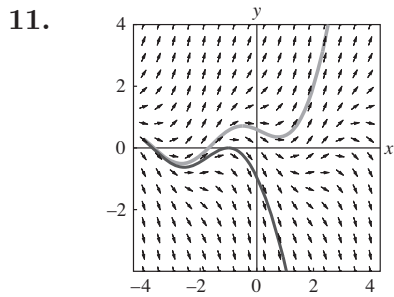
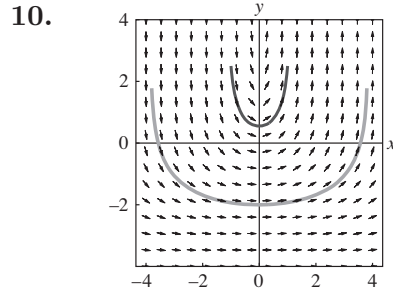
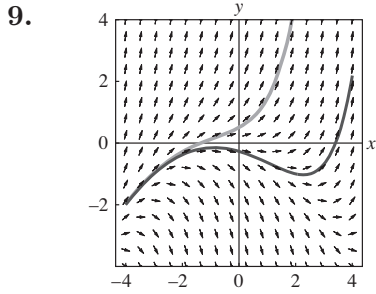
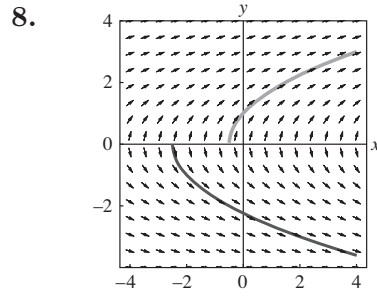
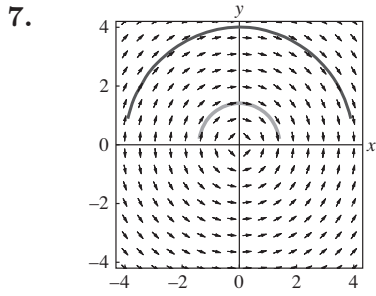

15. (a) The isoclines have the form $y = -x + c$, which are straight lines with slope -1 .

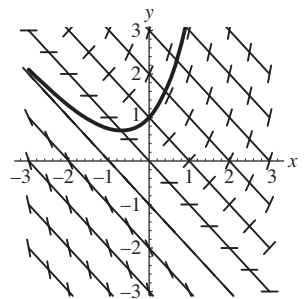

- (b) The isoclines have the form $x^2 + y^2 = c$, which are circles centered at the origin.

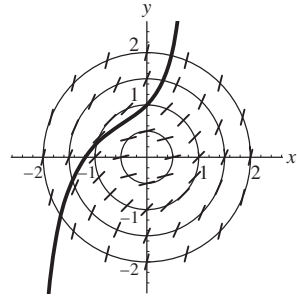

16. (a) When $x = 0$ or $y = 4$, $dy/dx = -2$ so the lineal elements have slope -2 . When $y = 3$ or $y = 5$, $dy/dx = x - 2$, so the lineal elements at $(x, 3)$ and $(x, 5)$ have slopes $x - 2$.
- (b) At $(0, y_0)$ the solution curve is headed down. If $y \rightarrow \infty$ as x increases, the graph must eventually turn around and head up, but while heading up it can never cross $y = 4$ where a tangent line to a solution curve must have slope -2 . Thus, y cannot approach ∞ as x approaches ∞ .

17. When $y < \frac{1}{2}x^2$, $y' = x^2 - 2y$ is positive and the portions of solution curves “outside” the nullcline parabola are increasing. When $y > \frac{1}{2}x^2$, $y' = x^2 - 2y$ is negative and the portions of the solution curves “inside” the nullcline parabola are decreasing.

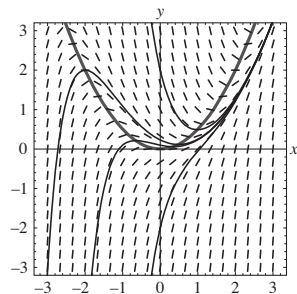

18. (a) Any horizontal lineal element should be at a point on a nullcline. In Problem 1 the nullclines are $x^2 - y^2 = 0$ or $y = \pm x$. In Problem 3 the nullclines are $1 - xy = 0$ or $y = 1/x$. In Problem 4 the nullclines are $(\sin x) \cos y = 0$ or $x = n\pi$ and $y = \pi/2 + n\pi$, where n is an integer. The graphs on the next page show the nullclines for the equations in Problems 1, 3, and 4 superimposed on the corresponding direction field.

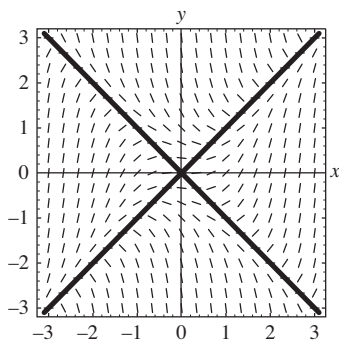

Problem 1

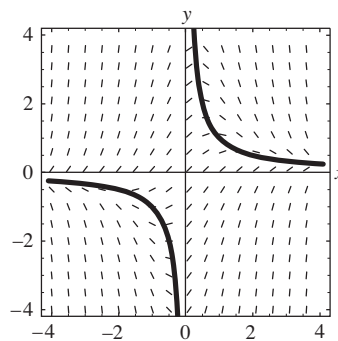

Problem 3

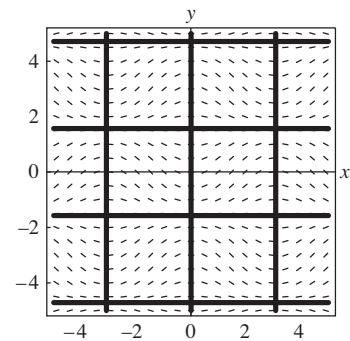

Problem 4

(b) An autonomous first-order differential equation has the form $y' = f(y)$. Nullclines have the form $y = c$ where $f(c) = 0$. These are the graphs of the equilibrium solutions of the differential equation.

19. Writing the differential equation in the form $dy/dx = y(1 - y)(1 + y)$ we see that critical points are $y = -1, y = 0, \text{ and } y = 1$. The phase portrait is shown at the right.

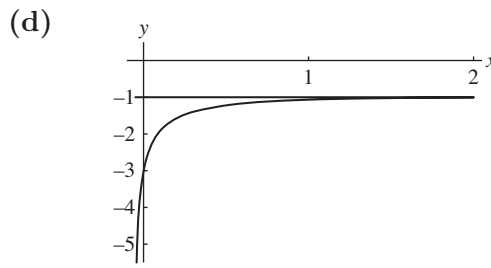
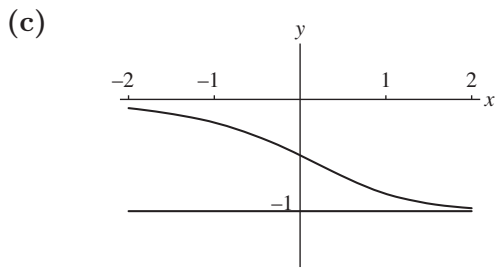
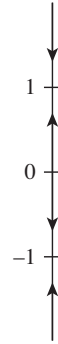
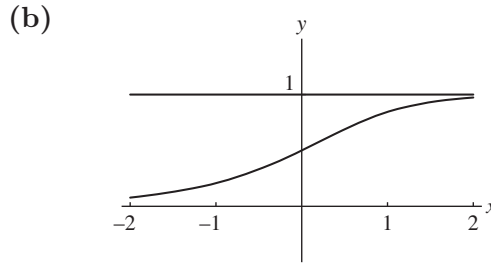
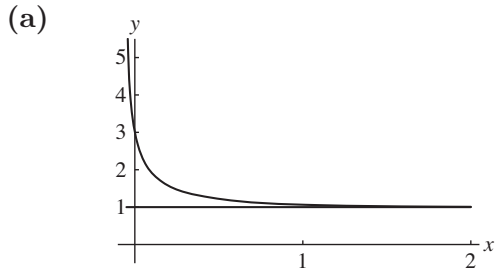

20. Writing the differential equation in the form $dy/dx = y^2(1 - y)(1 + y)$ we see that critical points are $y = -1, y = 0, \text{ and } y = 1$. The phase portrait is shown at the right.

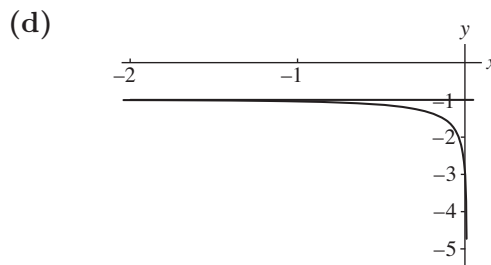
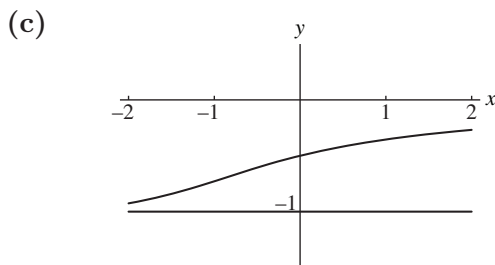
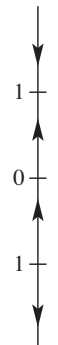
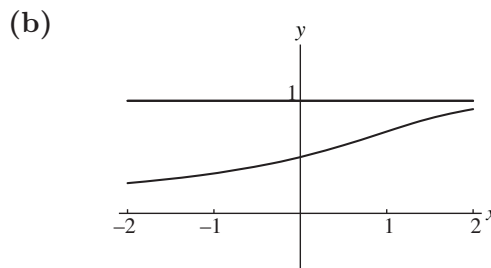
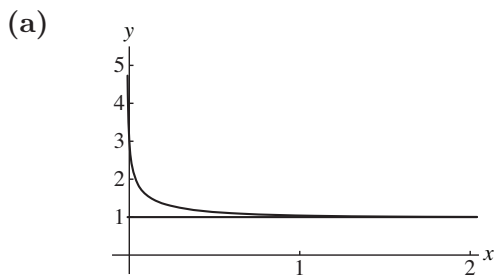

21. Solving $y^2 - 3y = y(y - 3) = 0$ we obtain the critical points 0 and 3. From the phase portrait we see that 0 is asymptotically stable (attractor) and 3 is unstable (repeller).

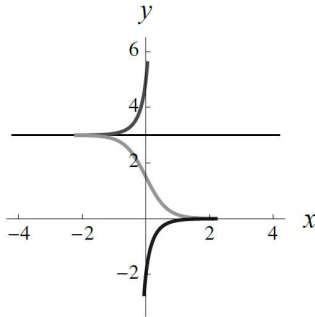

22. Solving $y^2 - y^3 = y^2(1 - y) = 0$ we obtain the critical points 0 and 1. From the phase portrait we see that 1 is asymptotically stable (attractor) and 0 is semi-stable.

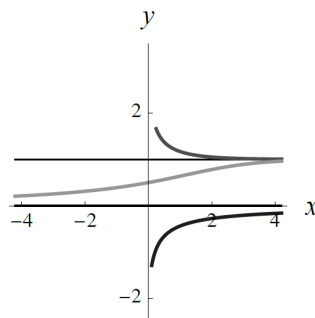

23. Solving $(y - 2)^4 = 0$ we obtain the critical point 2. From the phase portrait we see that 2 is semi-stable.

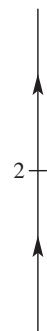
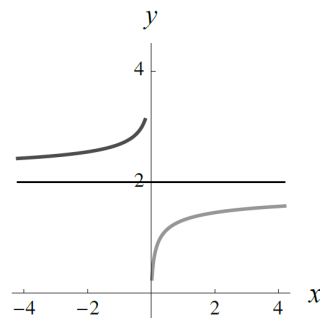

24. Solving $10 + 3y - y^2 = (5 - y)(2 + y) = 0$ we obtain the critical points -2 and 5 . From the phase portrait we see that 5 is asymptotically stable (attractor) and -2 is unstable (repeller).

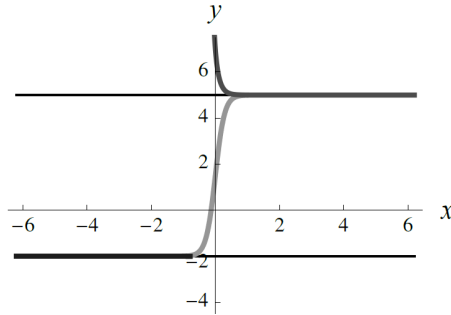

25. Solving $y^2(4 - y^2) = y^2(2 - y)(2 + y) = 0$ we obtain the critical points -2 , 0 , and 2 . From the phase portrait we see that 2 is asymptotically stable (attractor), 0 is semi-stable, and -2 is unstable (repeller).

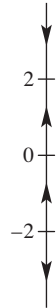
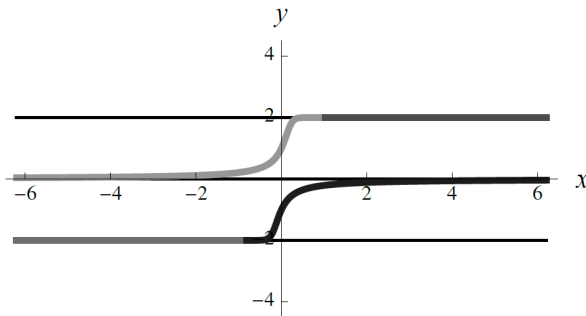

26. Solving $y(2 - y)(4 - y) = 0$ we obtain the critical points 0 , 2 , and 4 . From the phase portrait we see that 2 is asymptotically stable (attractor) and 0 and 4 are unstable (repellers).

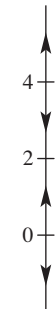
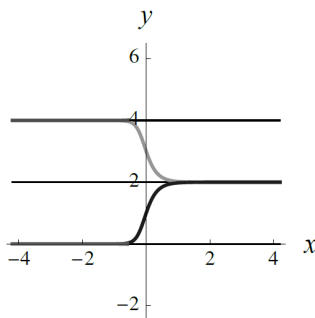

27. Solving $y \ln(y+2) = 0$ we obtain the critical points -1 and 0 . From the phase portrait we see that -1 is asymptotically stable (attractor) and 0 is unstable (repeller).

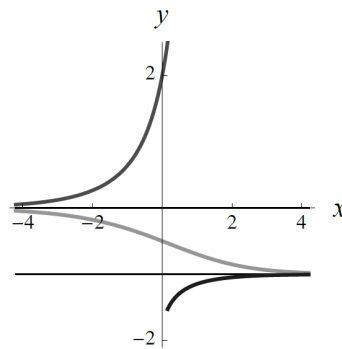

28. Solving $ye^y - 9y = y(e^y - 9) = 0$ (since e^y is always positive) we obtain the critical points 0 and $\ln 9$. From the phase portrait we see that 0 is asymptotically stable (attractor) and $\ln 9$ is unstable (repeller).

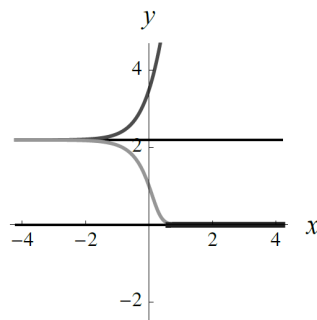

29. The critical points are 0 and c because the graph of $f(y)$ is 0 at these points. Since $f(y) > 0$ for $y < 0$ and $y > c$, the graph of the solution is increasing on the y -intervals $(-\infty, 0)$ and (c, ∞) . Since $f(y) < 0$ for $0 < y < c$, the graph of the solution is decreasing on the y -interval $(0, c)$.

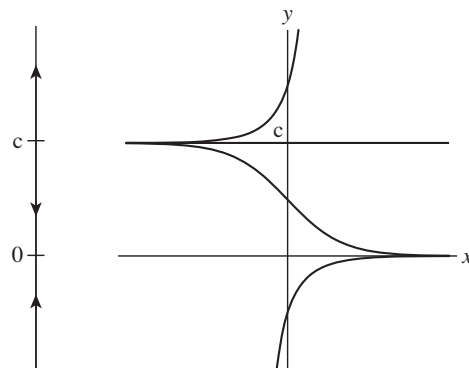

- 30.** The critical points are approximately at $-2, 2, 0.5$, and 1.7 . Since $f(y) > 0$ for $y < -2.2$ and $0.5 < y < 1.7$, the graph of the solution is increasing on the y -intervals $(-\infty, -2.2)$ and $(0.5, 1.7)$. Since $f(y) < 0$ for $-2.2 < y < 0.5$ and $y > 1.7$, the graph is decreasing on the y -interval $(-2.2, 0.5)$ and $(1.7, \infty)$.

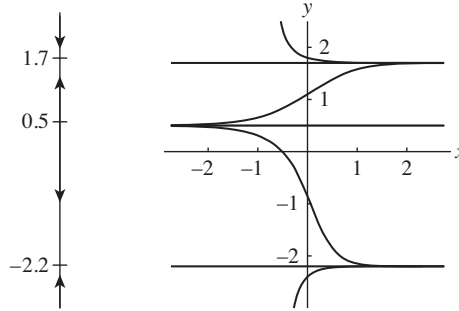

- 31.** From the graphs of $z = \pi/2$ and $z = \sin y$ we see that $(2/\pi)y - \sin y = 0$ has only three solutions. By inspection we see that the critical points are $-\pi/2, 0$, and $\pi/2$.

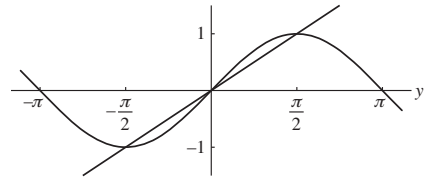

From the graph at the right we see that

$$\frac{2}{\pi}y - \sin y \begin{cases} < 0 & \text{for } y < -\pi/2 \\ > 0 & \text{for } y > \pi/2 \end{cases}$$

$$\frac{2}{\pi}y - \sin y \begin{cases} > 0 & \text{for } -\pi/2 < y < 0 \\ < 0 & \text{for } 0 < y < \pi/2 \end{cases}$$



This enables us to construct the phase portrait shown at the right. From this portrait we see that $\pi/2$ and $-\pi/2$ are unstable (repellers), and 0 is asymptotically stable (attractor).

- 32.** For $dy/dx = 0$ every real number is a critical point, and hence all critical points are nonisolated.
- 33.** Recall that for $dy/dx = f(y)$ we are assuming that f and f' are continuous functions of y on some interval I . Now suppose that the graph of a nonconstant solution of the differential equation crosses the line $y = c$. If the point of intersection is taken as an initial condition we have two distinct solutions of the initial-value problem. This violates uniqueness, so the

graph of any nonconstant solution must lie entirely on one side of any equilibrium solution. Since f is continuous it can only change signs at a point where it is 0. But this is a critical point. Thus, $f(y)$ is completely positive or completely negative in each region R_i . If $y(x)$ is oscillatory or has a relative extremum, then it must have a horizontal tangent line at some point (x_0, y_0) . In this case y_0 would be a critical point of the differential equation, but we saw above that the graph of a nonconstant solution cannot intersect the graph of the equilibrium solution $y = y_0$.

- 34.** By Problem 33, a solution $y(x)$ of $dy/dx = f(y)$ cannot have relative extrema and hence must be monotone. Since $y'(x) = f(y) > 0$, $y(x)$ is monotone increasing, and since $y(x)$ is bounded above by c_2 , $\lim_{x \rightarrow \infty} y(x) = L$, where $L \leq c_2$. We want to show that $L = c_2$. Since L is a horizontal asymptote of $y(x)$, $\lim_{x \rightarrow \infty} y'(x) = 0$. Using the fact that $f(y)$ is continuous we have

$$f(L) = f\left(\lim_{x \rightarrow \infty} y(x)\right) = \lim_{x \rightarrow \infty} f(y(x)) = \lim_{x \rightarrow \infty} y'(x) = 0.$$

But then L is a critical point of f . Since $c_1 < L \leq c_2$, and f has no critical points between c_1 and c_2 , $L = c_2$.

- 35.** Assuming the existence of the second derivative, points of inflection of $y(x)$ occur where $y''(x) = 0$. From $dy/dx = f(y)$ we have $d^2y/dx^2 = f'(y) dy/dx$. Thus, the y -coordinate of a point of inflection can be located by solving $f'(y) = 0$. (Points where $dy/dx = 0$ correspond to constant solutions of the differential equation.)

- 36.** Solving $y^2 - y - 6 = (y - 3)(y + 2) = 0$ we see that 3 and -2 are critical points. Now $d^2y/dx^2 = (2y - 1) dy/dx = (2y - 1)(y - 3)(y + 2)$, so the only possible point of inflection is at $y = \frac{1}{2}$, although the concavity of solutions can be different on either side of $y = -2$ and $y = 3$. Since $y''(x) < 0$ for $y < -2$ and $\frac{1}{2} < y < 3$, and $y''(x) > 0$ for $-2 < y < \frac{1}{2}$ and $y > 3$, we see that solution curves are concave down for $y < -2$ and $\frac{1}{2} < y < 3$ and concave up for $-2 < y < \frac{1}{2}$ and $y > 3$. Points of inflection of solutions of autonomous differential equations will have the same y -coordinates because between critical points they are horizontal translations of each other.

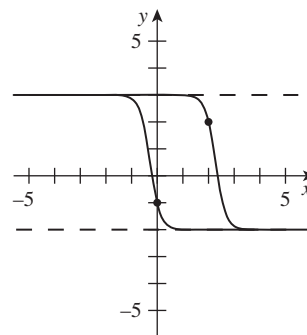

- 37.** If (1) in the text has no critical points it has no constant solutions. The solutions have neither an upper nor lower bound. Since solutions are monotonic, every solution assumes all real values.

38. The critical points are 0 and b/a . From the phase portrait we see that 0 is an attractor and b/a is a repeller. Thus, if an initial population satisfies $P_0 > b/a$, the population becomes unbounded as t increases, most probably in finite time, i.e. $P(t) \rightarrow \infty$ as $t \rightarrow T$. If $0 < P_0 < b/a$, then the population eventually dies out, that is, $P(t) \rightarrow 0$ as $t \rightarrow \infty$. Since population $P > 0$ we do not consider the case $P_0 < 0$.



39. From the equation $dP/dt = k(P - h/k)$ we see that the only critical point of the autonomous differential equation is the positive number h/k . A phase portrait shows that this point is unstable, that is, h/k is a repeller. For any initial condition $P(0) = P_0$ for which $0 < P_0 < h/k$, $dP/dt < 0$ which means $P(t)$ is monotonic decreasing and so the graph of $P(t)$ must cross the t -axis or the line $P = 0$ at some time $t_1 > 0$. But $P(t_1) = 0$ means the population is extinct at time t_1 .

40. Writing the differential equation in the form

$$\frac{dv}{dt} = \frac{k}{m} \left(\frac{mg}{k} - v \right)$$

we see that a critical point is mg/k .

From the phase portrait we see that mg/k is an asymptotically stable critical point. Thus, $\lim_{t \rightarrow \infty} v = mg/k$.

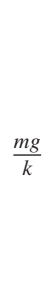

41. Writing the differential equation in the form

$$\frac{dv}{dt} = \frac{k}{m} \left(\frac{mg}{k} - v^2 \right) = \frac{k}{m} \left(\sqrt{\frac{mg}{k}} - v \right) \left(\sqrt{\frac{mg}{k}} + v \right)$$

we see that the only physically meaningful critical point is $\sqrt{mg/k}$.

From the phase portrait we see that $\sqrt{mg/k}$ is an asymptotically stable critical point. Thus, $\lim_{t \rightarrow \infty} v = \sqrt{mg/k}$.

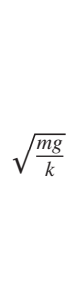

42. (a) From the phase portrait we see that critical points are α and β . Let $X(0) = X_0$. If $X_0 < \alpha$, we see that $X \rightarrow \alpha$ as $t \rightarrow \infty$. If $\alpha < X_0 < \beta$, we see that $X \rightarrow \alpha$ as $t \rightarrow \infty$. If $X_0 > \beta$, we see that $X(t)$ increases in an unbounded manner, but more specific behavior of $X(t)$ as $t \rightarrow \infty$ is not known.



- (b) When $\alpha = \beta$ the phase portrait is as shown. If $X_0 < \alpha$, then $X(t) \rightarrow \alpha$ as $t \rightarrow \infty$. If $X_0 > \alpha$, then $X(t)$ increases in an unbounded manner. This could happen in a finite amount of time. That is, the phase portrait does not indicate that X becomes unbounded as $t \rightarrow \infty$.

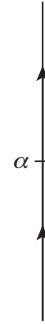

- (c) When $k = 1$ and $\alpha = \beta$ the differential equation is $dX/dt = (\alpha - X)^2$. For $X(t) = \alpha - 1/(t + c)$ we have $dX/dt = 1/(t + c)^2$ and

$$(\alpha - X)^2 = \left[\alpha - \left(\alpha - \frac{1}{t + c} \right) \right]^2 = \frac{1}{(t + c)^2} = \frac{dX}{dt}.$$

For $X(0) = \alpha/2$ we obtain

$$X(t) = \alpha - \frac{1}{t + 2/\alpha}.$$

For $X(0) = 2\alpha$ we obtain

$$X(t) = \alpha - \frac{1}{t - 1/\alpha}.$$

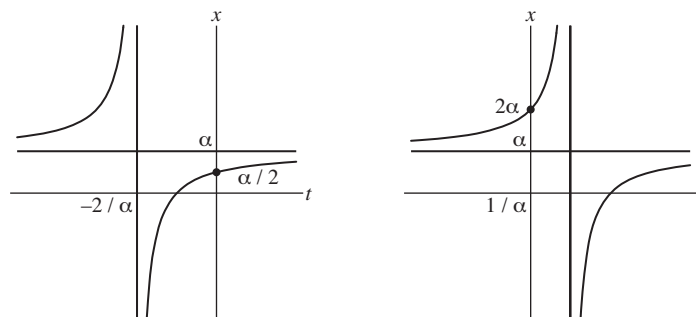

For $X_0 > \alpha$, $X(t)$ increases without bound up to $t = 1/\alpha$. For $t > 1/\alpha$, $X(t)$ increases but $X \rightarrow \alpha$ as $t \rightarrow \infty$.

2.2 Separable Variables

In many of the following problems we will encounter an expression of the form $\ln |g(y)| = f(x) + c$. To solve for $g(y)$ we exponentiate both sides of the equation. This yields $|g(y)| = e^{f(x)+c} = e^c e^{f(x)}$ which implies $g(y) = \pm e^c e^{f(x)}$. Letting $c_1 = \pm e^c$ we obtain $g(y) = c_1 e^{f(x)}$.

1. From $dy = \sin 5x \, dx$ we obtain $y = -\frac{1}{5} \cos 5x + c$.
2. From $dy = (x + 1)^2 \, dx$ we obtain $y = \frac{1}{3}(x + 1)^3 + c$.

3. From $dy = -e^{-3x} dx$ we obtain $y = \frac{1}{3}e^{-3x} + c$.
4. From $\frac{1}{(y-1)^2} dy = dx$ we obtain $-\frac{1}{y-1} = x + c$ or $y = 1 - \frac{1}{x+c}$.
5. From $\frac{1}{y} dy = \frac{4}{x} dx$ we obtain $\ln |y| = 4 \ln |x| + c$ or $y = c_1 x^4$.
6. From $\frac{1}{y^2} dy = -2x dx$ we obtain $-\frac{1}{y} = -x^2 + c$ or $y = \frac{1}{x^2 + c_1}$.
7. From $e^{-2y} dy = e^{3x} dx$ we obtain $3e^{-2y} + 2e^{3x} = c$.
8. From $ye^y dy = (e^{-x} + e^{-3x}) dx$ we obtain $ye^y - e^y + e^{-x} + \frac{1}{3}e^{-3x} = c$.
9. From $\left(y + 2 + \frac{1}{y}\right) dy = x^2 \ln x dx$ we obtain $\frac{y^2}{2} + 2y + \ln |y| = \frac{x^3}{3} \ln |x| - \frac{1}{9}x^3 + c$.
10. From $\frac{1}{(2y+3)^2} dy = \frac{1}{(4x+5)^2} dx$ we obtain $\frac{2}{2y+3} = \frac{1}{4x+5} + c$.
11. From $\frac{1}{\csc y} dy = -\frac{1}{\sec^2 x} dx$ or $\sin y dy = -\cos^2 x dx = -\frac{1}{2}(1 + \cos 2x) dx$ we obtain $-\cos y = -\frac{1}{2}x - \frac{1}{4}\sin 2x + c$ or $4\cos y = 2x + \sin 2x + c_1$.
12. From $2y dy = -\frac{\sin 3x}{\cos^3 3x} dx$ or $2y dy = -\tan 3x \sec^2 3x dx$ we obtain $y^2 = -\frac{1}{6}\sec^2 3x + c$.
13. From $\frac{e^y}{(e^y+1)^2} dy = \frac{-e^x}{(e^x+1)^3} dx$ we obtain $-(e^y+1)^{-1} = \frac{1}{2}(e^x+1)^{-2} + c$.
14. From $\frac{y}{(1+y^2)^{1/2}} dy = \frac{x}{(1+x^2)^{1/2}} dx$ we obtain $(1+y^2)^{1/2} = (1+x^2)^{1/2} + c$.
15. From $\frac{1}{S} dS = k dr$ we obtain $S = ce^{kr}$.
16. From $\frac{1}{Q-70} dQ = k dt$ we obtain $\ln |Q-70| = kt + c$ or $Q-70 = c_1 e^{kt}$.
17. From $\frac{1}{P-P^2} dP = \left(\frac{1}{P} + \frac{1}{1-P}\right) dP = dt$ we obtain $\ln |P| - \ln |1-P| = t + c$ so that $\ln \left|\frac{P}{1-P}\right| = t + c$ or $\frac{P}{1-P} = c_1 e^t$. Solving for P we have $P = \frac{c_1 e^t}{1 + c_1 e^t}$.
18. From $\frac{1}{N} dN = (te^{t+2} - 1) dt$ we obtain $\ln |N| = te^{t+2} - e^{t+2} - t + c$ or $N = c_1 e^{te^{t+2} - e^{t+2} - t}$.
19. From $\frac{y-2}{y+3} dy = \frac{x-1}{x+4} dx$ or $\left(1 - \frac{5}{y+3}\right) dy = \left(1 - \frac{5}{x+4}\right) dx$ we obtain $y - 5 \ln |y+3| = x - 5 \ln |x+4| + c$ or $\left(\frac{x+4}{y+3}\right)^5 = c_1 e^{x-y}$.

20. From $\frac{y+1}{y-1} dy = \frac{x+2}{x-3} dx$ or $\left(1 + \frac{2}{y-1}\right) dy = \left(1 + \frac{5}{x-3}\right) dx$ we obtain
 $y + 2 \ln |y-1| = x + 5 \ln |x-3| + c$ or $\frac{(y-1)^2}{(x-3)^5} = c_1 e^{x-y}$.
21. From $x dx = \frac{1}{\sqrt{1-y^2}} dy$ we obtain $\frac{1}{2}x^2 = \sin^{-1} y + c$ or $y = \sin\left(\frac{x^2}{2} + c_1\right)$.
22. From $\frac{1}{y^2} dy = \frac{1}{e^x + e^{-x}} dx = \frac{e^x}{(e^x)^2 + 1} dx$ we obtain $-\frac{1}{y} = \tan^{-1} e^x + c$ or
 $y = -\frac{1}{\tan^{-1} e^x + c}$.
23. From $\frac{1}{x^2+1} dx = 4 dt$ we obtain $\tan^{-1} x = 4t + c$. Using $x(\pi/4) = 1$ we find $c = -3\pi/4$. The solution of the initial-value problem is $\tan^{-1} x = 4t - \frac{3\pi}{4}$ or $x = \tan\left(4t - \frac{3\pi}{4}\right)$.
24. From $\frac{1}{y^2-1} dy = \frac{1}{x^2-1} dx$ or $\frac{1}{2}\left(\frac{1}{y-1} - \frac{1}{y+1}\right) dy = \frac{1}{2}\left(\frac{1}{x-1} - \frac{1}{x+1}\right) dx$ we obtain
 $\ln |y-1| - \ln |y+1| = \ln |x-1| - \ln |x+1| + \ln c$ or $\frac{y-1}{y+1} = \frac{c(x-1)}{x+1}$. Using $y(2) = 2$ we find $c = 1$. A solution of the initial-value problem is $\frac{y-1}{y+1} = \frac{x-1}{x+1}$ or $y = x$.
25. From $\frac{1}{y} dy = \frac{1-x}{x^2} dx = \left(\frac{1}{x^2} - \frac{1}{x}\right) dx$ we obtain $\ln |y| = -\frac{1}{x} - \ln |x| = c$ or $xy = c_1 e^{-1/x}$. Using $y(-1) = -1$ we find $c_1 = e^{-1}$. The solution of the initial-value problem is $xy = e^{-1-1/x}$ or $y = e^{-(1+1/x)}/x$.
26. From $\frac{1}{1-2y} dy = dt$ we obtain $-\frac{1}{2} \ln |1-2y| = t + c$ or $1-2y = c_1 e^{-2t}$. Using $y(0) = 5/2$ we find $c_1 = -4$. The solution of the initial-value problem is $1-2y = -4e^{-2t}$ or $y = 2e^{-2t} + \frac{1}{2}$.
27. Separating variables and integrating we obtain

$$\frac{dx}{\sqrt{1-x^2}} - \frac{dy}{\sqrt{1-y^2}} = 0 \quad \text{and} \quad \sin^{-1} x - \sin^{-1} y = c.$$

Setting $x = 0$ and $y = \sqrt{3}/2$ we obtain $c = -\pi/3$. Thus, an implicit solution of the initial-value problem is $\sin^{-1} x - \sin^{-1} y = \pi/3$. Solving for y and using an addition formula from trigonometry, we get

$$y = \sin\left(\sin^{-1} x + \frac{\pi}{3}\right) = x \cos \frac{\pi}{3} + \sqrt{1-x^2} \sin \frac{\pi}{3} = \frac{x}{2} + \frac{\sqrt{3}\sqrt{1-x^2}}{2}.$$

28. From $\frac{1}{1+(2y)^2} dy = \frac{-x}{1+(x^2)^2} dx$ we obtain

$$\frac{1}{2} \tan^{-1} 2y = -\frac{1}{2} \tan^{-1} x^2 + c \quad \text{or} \quad \tan^{-1} 2y + \tan^{-1} x^2 = c_1.$$

Using $y(1) = 0$ we find $c_1 = \pi/4$. Thus, an implicit solution of the initial-value problem is $\tan^{-1} 2y + \tan^{-1} x^2 = \pi/4$. Solving for y and using a trigonometric identity we get

$$\begin{aligned} 2y &= \tan\left(\frac{\pi}{4} - \tan^{-1} x^2\right) \\ y &= \frac{1}{2} \tan\left(\frac{\pi}{4} - \tan^{-1} x^2\right) \\ &= \frac{1}{2} \frac{\tan \frac{\pi}{4} - \tan(\tan^{-1} x^2)}{1 + \tan \frac{\pi}{4} \tan(\tan^{-1} x^2)} \\ &= \frac{1}{2} \frac{1 - x^2}{1 + x^2}. \end{aligned}$$

29. Separating variables and then proceeding as in Example 5 we get

$$\begin{aligned} \frac{dy}{dx} &= ye^{-x^2} \\ \frac{1}{y} \frac{dy}{dx} &= e^{-x^2} \\ \int_4^x \frac{1}{y(t)} \frac{dy}{dt} dt &= \int_4^x e^{-t^2} dt \\ \ln y(t) \Big|_4^x &= \int_4^x e^{-t^2} dt \\ \ln y(x) - \ln y(4) &= \int_4^x e^{-t^2} dt \\ \ln y(x) &= \int_4^x e^{-t^2} dt \\ y(x) &= e^{\int_4^x e^{-t^2} dt} \end{aligned}$$

30. Separating variables and then proceeding as in Example 5 we get

$$\begin{aligned}\frac{dy}{dx} &= y^2 \sin(x^2) \\ \frac{1}{y^2} \frac{dy}{dx} &= \sin(x^2) \\ \int_{-2}^x \frac{1}{y^2(t)} \frac{dy}{dt} dt &= \int_{-2}^x \sin(t^2) dt \\ \frac{-1}{y(t)} \Big|_{-2}^x &= \int_{-2}^x \sin(t^2) dt \\ \frac{-1}{y(x)} + \frac{1}{y(-2)} &= \int_{-2}^x \sin(t^2) dt \\ \frac{-1}{y(x)} + 3 &= \int_{-2}^x \sin(t^2) dt \\ y(x) &= \left[3 - \int_{-2}^x \sin(t^2) dt \right]^{-1}\end{aligned}$$

31. Separating variables we get

$$\begin{aligned}\frac{dy}{dx} &= \frac{2x+1}{2y} \\ 2y dy &= (2x+1) dx \\ \int 2y dy &= \int (2x+1) dx \\ y^2 &= x^2 + x + c\end{aligned}$$

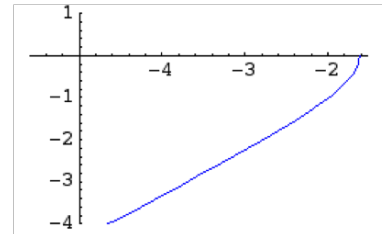

The condition $y(-2) = -1$ implies $c = -1$. Thus $y^2 = x^2 + x - 1$ and $y = -\sqrt{x^2 + x - 1}$ in order for y to be negative. Moreover for an interval containing -2 for values of x such that $x^2 + x - 1 > 0$ we get $\left(-\infty, -\frac{1}{2} - \frac{\sqrt{5}}{2}\right)$.

32. Separating variables we get

$$\begin{aligned}(2y - 2) \frac{dy}{dx} &= 3x^2 + 4x + 2 \\ (2y - 2) dy &= (3x^2 + 4x + 2) dx \\ \int (2y - 2) dy &= \int (3x^2 + 4x + 2) dx \\ \int 2(y - 1) dy &= \int (3x^2 + 4x + 2) dx \\ (y - 1)^2 &= x^3 + 2x^2 + 2x + c\end{aligned}$$

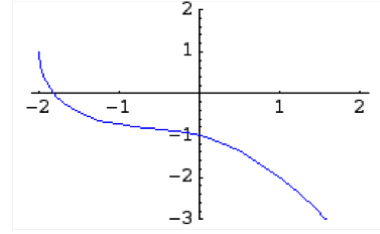

The condition $y(1) = -2$ implies $c = 4$. Thus $y = 1 - \sqrt{x^3 + 2x^2 + 2x + 4}$ where the minus sign is indicated by the initial condition. Now $x^3 + 2x^2 + 2x + 4 = (x + 2)(x^2 + 1) > 0$ implies $x > -2$, so the interval of definition is $(-2, \infty)$.

33. Separating variables we get

$$\begin{aligned}e^y dx - e^{-x} dy &= 0 \\ e^y dx &= e^{-x} dy \\ e^x dx &= e^{-y} dy \\ \int e^x dx &= \int e^{-y} dy \\ e^x &= -e^{-y} + c\end{aligned}$$

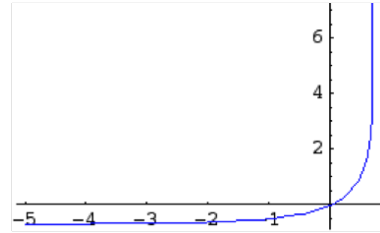

The condition $y(0) = 0$ implies $c = 2$. Thus $e^{-y} = 2 - e^x$. Therefore $y = -\ln(2 - e^x)$. Now we must have $2 - e^x > 0$ or $e^x < 2$. Since e^x is an increasing function this implies $x < \ln 2$ and so the interval of definition is $(-\infty, \ln 2)$.

34. Separating variables we get

$$\begin{aligned}\sin x dx + y dy &= 0 \\ \int \sin x dx + \int y dy &= \int 0 dx \\ -\cos x + \frac{1}{2}y^2 &= c\end{aligned}$$

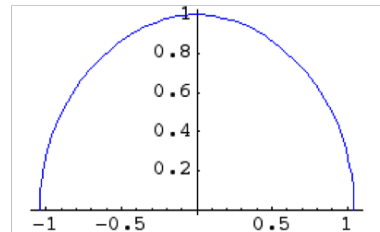

The condition $y(0) = 1$ implies $c = -\frac{1}{2}$. Thus $-\cos x + \frac{1}{2}y^2 = -\frac{1}{2}$ or $y^2 = 2\cos x - 1$. Therefore $y = \sqrt{2\cos x - 1}$ where the positive root is indicated by the initial condition. Now we must have $2\cos x - 1 > 0$ or $\cos x > \frac{1}{2}$. This means $-\pi/3 < x < \pi/3$, so the interval of definition is $(-\pi/3, \pi/3)$.

35. (a) The equilibrium solutions $y(x) = 2$ and $y(x) = -2$ satisfy the initial conditions $y(0) = 2$

and $y(0) = -2$, respectively. Setting $x = \frac{1}{4}$ and $y = 1$ in $y = 2(1 + ce^{4x})/(1 - ce^{4x})$ we obtain

$$1 = 2\frac{1+ce}{1-ce}, \quad 1 - ce = 2 + 2ce, \quad -1 = 3ce, \quad \text{and} \quad c = -\frac{1}{3e}.$$

The solution of the corresponding initial-value problem is

$$y = 2\frac{1 - \frac{1}{3}e^{4x-1}}{1 + \frac{1}{3}e^{4x-1}} = 2\frac{3 - e^{4x-1}}{3 + e^{4x-1}}.$$

(b) Separating variables and integrating yields

$$\frac{1}{4} \ln |y - 2| - \frac{1}{4} \ln |y + 2| + \ln c_1 = x$$

$$\ln |y - 2| - \ln |y + 2| + \ln c = 4x$$

$$\ln \left| \frac{c(y - 2)}{y + 2} \right| = 4x$$

$$c \frac{y - 2}{y + 2} = e^{4x}.$$

Solving for y we get $y = 2(c + e^{4x})/(c - e^{4x})$. The initial condition $y(0) = -2$ implies $2(c + 1)/(c - 1) = -2$ which yields $c = 0$ and $y(x) = -2$. The initial condition $y(0) = 2$ does not correspond to a value of c , and it must simply be recognized that $y(x) = 2$ is a solution of the initial-value problem. Setting $x = \frac{1}{4}$ and $y = 1$ in $y = 2(c + e^{4x})/(c - e^{4x})$ leads to $c = -3e$. Thus, a solution of the initial-value problem is

$$y = 2\frac{-3e + e^{4x}}{-3e - e^{4x}} = 2\frac{3 - e^{4x-1}}{3 + e^{4x-1}}.$$

36. Separating variables, we have

$$\frac{dy}{y^2 - y} = \frac{dx}{x} \quad \text{or} \quad \int \frac{dy}{y(y - 1)} = \ln |x| + c.$$

Using partial fractions, we obtain

$$\int \left(\frac{1}{y - 1} - \frac{1}{y} \right) dy = \ln |x| + c$$

$$\ln |y - 1| - \ln |y| = \ln |x| + c$$

$$\ln \left| \frac{y - 1}{xy} \right| = c$$

$$\frac{y - 1}{xy} = e^c = c_1.$$

Solving for y we get $y = 1/(1 - c_1x)$. We note by inspection that $y = 0$ is a singular solution of the differential equation.

(a) Setting $x = 0$ and $y = 1$ we have $1 = 1/(1 - 0)$, which is true for all values of c_1 . Thus, solutions passing through $(0, 1)$ are $y = 1/(1 - c_1x)$.

(b) Setting $x = 0$ and $y = 0$ in $y = 1/(1 - c_1x)$ we get $0 = 1$. Thus, the only solution passing through $(0, 0)$ is $y = 0$.

(c) Setting $x = \frac{1}{2}$ and $y = \frac{1}{2}$ we have $\frac{1}{2} = 1/(1 - \frac{1}{2}c_1)$, so $c_1 = -2$ and $y = 1/(1 + 2x)$.

(d) Setting $x = 2$ and $y = \frac{1}{4}$ we have $\frac{1}{4} = 1/(1 - 2c_1)$, so $c_1 = -\frac{3}{2}$ and $y = 1/(1 + \frac{3}{2}x) = 2/(2 + 3x)$.

37. Singular solutions of $dy/dx = x\sqrt{1 - y^2}$ are $y = -1$ and $y = 1$. A singular solution of $(e^x + e^{-x})dy/dx = y^2$ is $y = 0$.

38. Differentiating $\ln(x^2 + 10) + \csc y = c$ we get

$$\frac{2x}{x^2 + 10} - \csc y \cot y \frac{dy}{dx} = 0,$$

$$\frac{2x}{x^2 + 10} - \frac{1}{\sin y} \cdot \frac{\cos y}{\sin y} \frac{dy}{dx} = 0,$$

or

$$2x \sin^2 y dx - (x^2 + 10) \cos y dy = 0.$$

Writing the differential equation in the form

$$\frac{dy}{dx} = \frac{2x \sin^2 y}{(x^2 + 10) \cos y}$$

we see that singular solutions occur when $\sin^2 y = 0$, or $y = k\pi$, where k is an integer.

39. The singular solution $y = 1$ satisfies the initial-value problem.

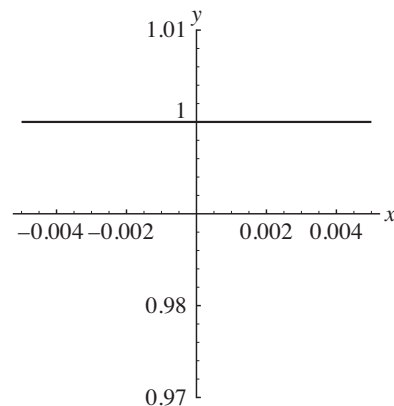

40. Separating variables we obtain $\frac{dy}{(y-1)^2} = dx$. Then

$$-\frac{1}{y-1} = x+c \quad \text{and} \quad y = \frac{x+c-1}{x+c}.$$

Setting $x=0$ and $y=1.01$ we obtain $c=-100$. The solution is

$$y = \frac{x-101}{x-100}.$$

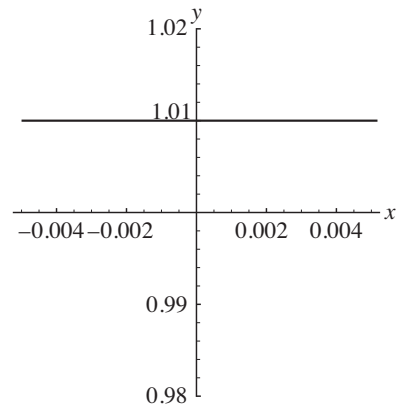

41. Separating variables we obtain $\frac{dy}{(y-1)^2 + 0.01} = dx$. Then

$$10 \tan^{-1} 10(y-1) = x+c \quad \text{and} \quad y = 1 + \frac{1}{10} \tan \frac{x+c}{10}.$$

Setting $x=0$ and $y=1$ we obtain $c=0$. The solution is

$$y = 1 + \frac{1}{10} \tan \frac{x}{10}.$$

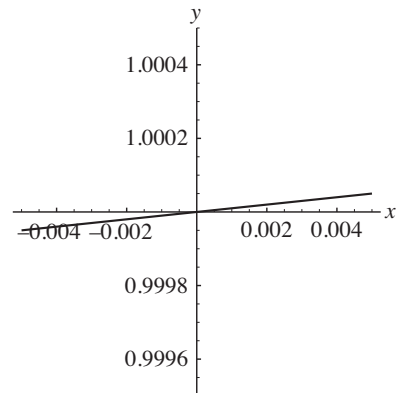

42. Separating variables we obtain $\frac{dy}{(y-1)^2 - 0.01} = dx$. Then, with $u = y-1$ and $a = \frac{1}{10}$, we get

$$5 \ln \left| \frac{10y-11}{10y-9} \right| = x+c.$$

Setting $x=0$ and $y=1$ we obtain $c = 5 \ln 1 = 0$. The solution is

$$5 \ln \left| \frac{10y-11}{10y-9} \right| = x.$$

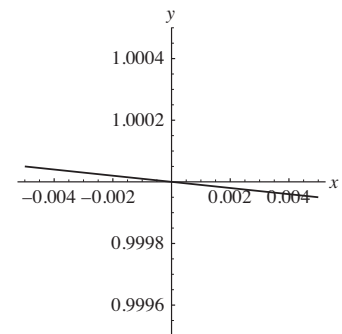

Solving for y we obtain

$$y = \frac{11 + 9e^{x/5}}{10 + 10e^{x/5}}.$$

Alternatively, we can use the fact that

$$\int \frac{dy}{(y-1)^2 - 0.01} = -\frac{1}{0.1} \tanh^{-1} \frac{y-1}{0.1} = -10 \tanh^{-1} 10(y-1).$$

(We use the inverse hyperbolic tangent because $|y-1| < 0.1$ or $0.9 < y < 1.1$. This follows from the initial condition $y(0) = 1$.) Solving the above equation for y we get $y = 1 + 0.1 \tanh(x/10)$.

43. Separating variables, we have

$$\frac{dy}{y - y^3} = \frac{dy}{y(1 - y)(1 + y)} = \left(\frac{1}{y} + \frac{1/2}{1 - y} - \frac{1/2}{1 + y} \right) dy = dx.$$

Integrating, we get

$$\ln |y| - \frac{1}{2} \ln |1 - y| - \frac{1}{2} \ln |1 + y| = x + c.$$

When $y > 1$, this becomes

$$\ln y - \frac{1}{2} \ln (y - 1) - \frac{1}{2} \ln (y + 1) = \ln \frac{y}{\sqrt{y^2 - 1}} = x + c.$$

Letting $x = 0$ and $y = 2$ we find $c = \ln(2/\sqrt{3})$. Solving for y we get $y_1(x) = 2e^x/\sqrt{4e^{2x} - 3}$, where $x > \ln(\sqrt{3}/2)$.

When $0 < y < 1$ we have

$$\ln y - \frac{1}{2} \ln (1 - y) - \frac{1}{2} \ln (1 + y) = \ln \frac{y}{\sqrt{1 - y^2}} = x + c.$$

Letting $x = 0$ and $y = \frac{1}{2}$ we find $c = \ln(1/\sqrt{3})$. Solving for y we get $y_2(x) = e^x/\sqrt{e^{2x} + 3}$, where $-\infty < x < \infty$.

When $-1 < y < 0$ we have

$$\ln(-y) - \frac{1}{2} \ln(1 - y) - \frac{1}{2} \ln(1 + y) = \ln \frac{-y}{\sqrt{1 - y^2}} = x + c.$$

Letting $x = 0$ and $y = -\frac{1}{2}$ we find $c = \ln(1/\sqrt{3})$. Solving for y we get $y_3(x) = -e^x/\sqrt{e^{2x} + 3}$, where $-\infty < x < \infty$.

When $y < -1$ we have

$$\ln(-y) - \frac{1}{2} \ln(1 - y) - \frac{1}{2} \ln(-1 - y) = \ln \frac{-y}{\sqrt{y^2 - 1}} = x + c.$$

Letting $x = 0$ and $y = -2$ we find $c = \ln(2/\sqrt{3})$. Solving for y we get $y_4(x) = -2e^x/\sqrt{4e^{2x} - 3}$, where $x > \ln(\sqrt{3}/2)$.

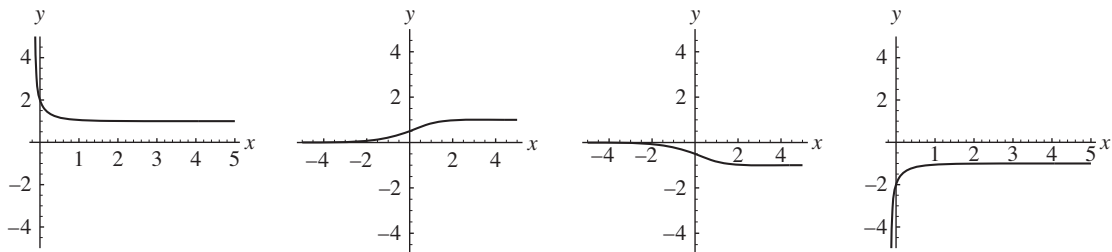

44. (a) The second derivative of y is

$$\frac{d^2y}{dx^2} = -\frac{dy/dx}{(y-1)^2} = -\frac{1/(y-3)}{(y-3)^2} = -\frac{1}{(y-3)^3}.$$

The solution curve is concave down when $d^2y/dx^2 < 0$ or $y > 3$, and concave up when $d^2y/dx^2 > 0$ or $y < 3$. From the phase portrait we see that the solution curve is decreasing when $y < 3$ and increasing when $y > 3$.

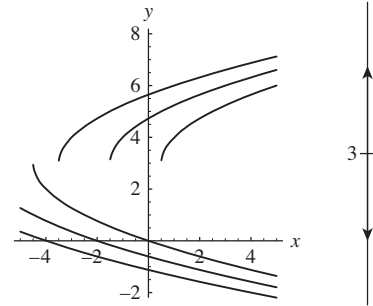

- (b) Separating variables and integrating we obtain

$$\begin{aligned}(y-3) dy &= dx \\ \frac{1}{2}y^2 - 3y &= x + c \\ y^2 - 6y + 9 &= 2x + c_1 \\ (y-3)^2 &= 2x + c_1 \\ y &= 3 \pm \sqrt{2x + c_1}.\end{aligned}$$

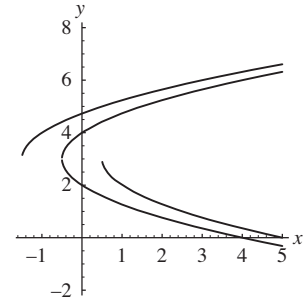

The initial condition dictates whether to use the plus or minus sign.

When $y_1(0) = 4$ we have $c_1 = 1$ and $y_1(x) = 3 + \sqrt{2x+1}$ where $(-1/2, \infty)$.

When $y_2(0) = 2$ we have $c_1 = 1$ and $y_2(x) = 3 - \sqrt{2x+1}$ where $(-1/2, \infty)$.

When $y_3(1) = 2$ we have $c_1 = -1$ and $y_3(x) = 3 - \sqrt{2x-1}$ where $(1/2, \infty)$.

When $y_4(-1) = 4$ we have $c_1 = 3$ and $y_4(x) = 3 + \sqrt{2x+3}$ where $(-3/2, \infty)$.

45. We separate variables and rationalize the denominator. Then

$$\begin{aligned}dy &= \frac{1}{1+\sin x} \cdot \frac{1-\sin x}{1-\sin x} dx = \frac{1-\sin x}{1-\sin^2 x} dx = \frac{1-\sin x}{\cos^2 x} dx \\ &= (\sec^2 x - \tan x \sec x) dx.\end{aligned}$$

Integrating, we have $y = \tan x - \sec x + C$.

46. Separating variables we have $\sqrt{y} dy = \sin \sqrt{x} dx$. Then

$$\int \sqrt{y} dy = \int \sin \sqrt{x} dx \quad \text{and} \quad \frac{2}{3}y^{3/2} = \int \sin \sqrt{x} dx.$$

To integrate $\sin \sqrt{x}$ we first make the substitution $u = \sqrt{x}$. Then $du = \frac{1}{2\sqrt{x}} dx = \frac{1}{2u} du$ and

$$\int \sin \sqrt{x} dx = \int (\sin u)(2u) du = 2 \int u \sin u du.$$

Using integration by parts we find

$$\int u \sin u \, du = -u \cos u + \sin u = -\sqrt{x} \cos \sqrt{x} + \sin \sqrt{x}.$$

Thus

$$\frac{2}{3}y = \int \sin \sqrt{x} \, dx = -2\sqrt{x} \cos \sqrt{x} + 2 \sin \sqrt{x} + C$$

and

$$y = 3^{2/3} (-\sqrt{x} \cos \sqrt{x} + \sin \sqrt{x} + C).$$

47. Separating variables we have $dy/(\sqrt{y} + y) = dx/(\sqrt{x} + x)$. To integrate $\int dx/(\sqrt{x} + x)$ we substitute $u^2 = x$ and get

$$\int \frac{2u}{u + u^2} \, du = \int \frac{2}{1 + u} \, du = 2 \ln |1 + u| + c = 2 \ln (1 + \sqrt{x}) + c.$$

Integrating the separated differential equation we have

$$2 \ln (1 + \sqrt{y}) = 2 \ln (1 + \sqrt{x}) + c \quad \text{or} \quad \ln (1 + \sqrt{y}) = \ln (1 + \sqrt{x}) + \ln c_1.$$

Solving for y we get $y = [c_1 (1 + \sqrt{x}) - 1]^2$.

48. Separating variables and integrating we have

$$\int \frac{dy}{y^{2/3} (1 - y^{1/3})} = \int dx$$

$$\int \frac{y^{2/3}}{1 - y^{1/3}} \, dy = x + c_1$$

$$-3 \ln |1 - y^{1/3}| = x + c_1$$

$$\ln |1 - y^{1/3}| = -\frac{x}{3} + c_2$$

$$|1 - y^{1/3}| = c_3 e^{-x/3}$$

$$1 - y^{1/3} = c_4 e^{-x/3}$$

$$y^{1/3} = 1 + c_5 e^{-x/3}$$

$$y = (1 + c_5 e^{-x/3})^3.$$

49. Separating variables we have $y dy = e^{\sqrt{x}} dx$. If $u = \sqrt{x}$, then $u^2 = x$ and $2u du = dx$. Thus, $\int e^{\sqrt{x}} dx = \int 2ue^u du$ and, using integration by parts, we find

$$\int y dy = \int e^{\sqrt{x}} dx \quad \text{so} \quad \frac{1}{2} y^2 = \int 2ue^u du = -2e^u + C = 2\sqrt{x} e^{\sqrt{x}} - 2e^{\sqrt{x}} + C,$$

and

$$y = 2\sqrt{\sqrt{x} e^{\sqrt{x}} - e^{\sqrt{x}} + C}.$$

To find C we solve $y(1) = 4$.

$$y(1) = 2\sqrt{\sqrt{1} e^{\sqrt{1}} - e^{\sqrt{1}} + C} = 2\sqrt{C} = 4 \quad \text{so} \quad C = 4.$$

and the solution of the initial-value problem is $y = 2\sqrt{\sqrt{x} e^{\sqrt{x}} - e^{\sqrt{x}} + 4}$.

50. Separating variables we have $y dy = x \tan^{-1} x dx$. Integrating both sides and using integration by parts with $u = \tan^{-1} x$ and $dv = x dx$ we have

$$\begin{aligned} \int y dy &= \int x \tan^{-1} x dx \\ \frac{1}{2} y^2 &= \frac{1}{2} x^2 \tan^{-1} x - \frac{1}{2} x + \frac{1}{2} \tan^{-1} x + C \\ y^2 &= x^2 \tan^{-1} x - x + \tan^{-1} x + C_1 \\ y &= \sqrt{x^2 \tan^{-1} x - x + \tan^{-1} x + C_1} \end{aligned}$$

To find C_1 we solve $y(0) = 3$.

$$y(0) = \sqrt{0^2 \tan^{-1} 0 - 0 + \tan^{-1} 0 + C_1} = \sqrt{C_1} = 3 \quad \text{so} \quad C_1 = 9,$$

and the solution of the initial-value problem is $y = \sqrt{x^2 \tan^{-1} x - x + \tan^{-1} x + 9}$.

51. (a) While $y_2(x) = -\sqrt{25 - x^2}$ is defined at $x = -5$ and $x = 5$, $y_2'(x)$ is not defined at these values, and so the interval of definition is the open interval $(-5, 5)$.

(b) At any point on the x -axis the derivative of $y(x)$ is undefined, so no solution curve can cross the x -axis. Since $-x/y$ is not defined when $y = 0$, the initial-value problem has no solution.

52. The derivative of $y = (\frac{1}{4}x^2 - 1)^2$ is $dy/dx = x(\frac{1}{4}x^2 - 1)$. We note that $xy^{1/2} = x|\frac{1}{4}x^2 - 1|$. We see from the graphs of y (black), dy/dx (red), and $xy^{1/2}$ (blue), below that $dy/dx = xy^{1/2}$ on $(-\infty, 2]$ and $[2, \infty)$.

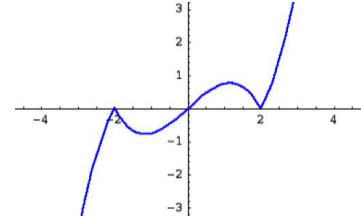
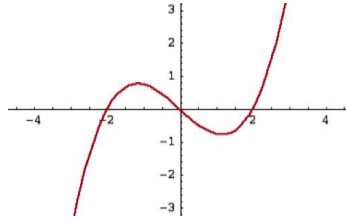
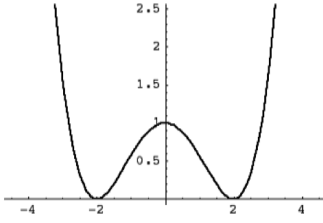

Alternatively, because $\sqrt{X^2} = |X|$ we can write

$$xy^{1/2} = x\sqrt{y} = x\sqrt{\left(\frac{1}{4}x^2 - 1\right)^2} = x\left|\frac{1}{4}x^2 - 1\right| = \begin{cases} x\left(\frac{1}{4}x^2 - 1\right), & -\infty < x \leq -2 \\ -x\left(\frac{1}{4}x^2 - 1\right), & -2 < x < 2 \\ x\left(\frac{1}{4}x^2 - 1\right), & 2 \leq x < \infty. \end{cases}$$

From this we see that $dy/dx = xy^{1/2}$ on $(-\infty, -2]$ and on $[2, \infty)$.

- 53.** Separating variables we have $dy/\left(\sqrt{1+y^2} \sin^2 y\right) = dx$ which is not readily integrated (even by a CAS). We note that $dy/dx \geq 0$ for all values of x and y and that $dy/dx = 0$ when $y = 0$ and $y = \pi$, which are equilibrium solutions.

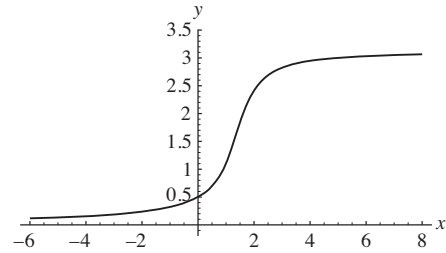

- 54. (a)** The solution of $y' = y$, $y(0) = 1$, is $y = e^x$. Using separation of variables we find that the solution of $y' = y[1 + 1/(x \ln x)]$, $y(e) = 1$, is $y = e^{x-e} \ln x$. Solving the two solutions simultaneously we obtain

$$e^x = e^{x-e} \ln x, \quad \text{so} \quad e^e = \ln x \quad \text{and} \quad x = e^{e^e}.$$

- (b)** Since $y = e^{(e^{e^e})} \approx 2.33 \times 10^{1,656,520}$, the y -coordinate of the point of intersection of the two solution curves has over 1.65 million digits.

- 55.** We are looking for a function $y(x)$ such that

$$y^2 + \left(\frac{dy}{dx}\right)^2 = 1.$$

Using the positive square root gives

$$\begin{aligned} \frac{dy}{dx} &= \sqrt{1-y^2} \\ \frac{dy}{\sqrt{1-y^2}} &= dx \\ \sin^{-1} y &= x + c. \end{aligned}$$

Thus a solution is $y = \sin(x + c)$. If we use the negative square root we obtain

$$y = \sin(c - x) = -\sin(x - c) = -\sin(x + c_1).$$

Note that when $c = c_1 = 0$ and when $c = c_1 = \pi/2$ we obtain the well known particular solutions $y = \sin x$, $y = -\sin x$, $y = \cos x$, and $y = -\cos x$. Note also that $y = 1$ and $y = -1$ are singular solutions.

56. (a)

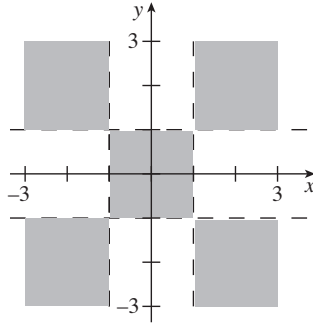

(b) For $|x| > 1$ and $|y| > 1$ the differential equation is $dy/dx = \sqrt{y^2 - 1}/\sqrt{x^2 - 1}$. Separating variables and integrating, we obtain

$$\frac{dy}{\sqrt{y^2 - 1}} = \frac{dx}{\sqrt{x^2 - 1}} \quad \text{and} \quad \cosh^{-1} y = \cosh^{-1} x + c.$$

Setting $x = 2$ and $y = 2$ we find $c = \cosh^{-1} 2 - \cosh^{-1} 2 = 0$ and $\cosh^{-1} y = \cosh^{-1} x$. An explicit solution is $y = x$.

57. Since the tension T_1 (or magnitude T_1) acts at the lowest point of the cable, we use symmetry to solve the problem on the interval $[0, L/2]$. The assumption that the roadbed is uniform (that is, weighs a constant ρ pounds per horizontal foot) implies $W = \rho x$, where x is measured in feet and $0 \leq x \leq L/2$. Therefore (10) becomes $dy/dx = (\rho/T_1)x$. This last equation is a separable equation of the form given in (1) of Section 2.2 in the text. Integrating and using the initial condition $y(0) = a$ shows that the shape of the cable is a parabola: $y(x) = (\rho/2T_1)x^2 + a$. In terms of the sag h of the cable and the span L , we see from Figure 2.2.5 in the text that $y(L/2) = h + a$. By applying this last condition to $y(x) = (\rho/2T_1)x^2 + a$ enables us to express $\rho/2T_1$ in terms of h and L : $y(x) = (4h/L^2)x^2 + a$. Since $y(x)$ is an even function of x , the solution is valid on $-L/2 \leq x \leq L/2$.

58. (a) Separating variables and integrating, we have

$$(3y^2 + 1) dy = -(8x + 5) dx \quad \text{and} \quad y^3 + y = -4x^2 - 5x + c.$$

Using a CAS we show various contours of

$f(x, y) = y^3 + y + 4x^2 + 5x$. The plots shown on $[-5, 5] \times [-5, 5]$ correspond to c -values of $0, \pm 5, \pm 20, \pm 40, \pm 80$, and ± 125 .

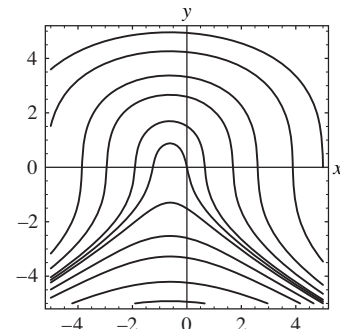

- (b) The value of c corresponding to $y(0) = -1$ is $f(0, -1) = -2$; to $y(0) = 2$ is $f(0, 2) = 10$; to $y(-1) = 4$ is $f(-1, 4) = 67$; and to $y(-1) = -3$ is -31 .

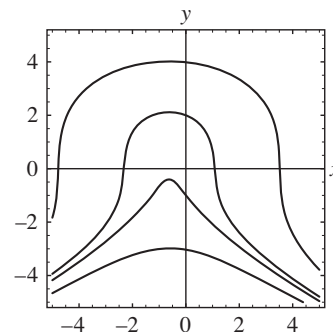

59. (a) An implicit solution of the differential equation $(2y + 2)dy - (4x^3 + 6x) dx = 0$ is

$$y^2 + 2y - x^4 - 3x^2 + c = 0.$$

The condition $y(0) = -3$ implies that $c = -3$. Therefore $y^2 + 2y - x^4 - 3x^2 - 3 = 0$.

- (b) Using the quadratic formula we can solve for y in terms of x :

$$y = \frac{-2 \pm \sqrt{4 + 4(x^4 + 3x^2 + 3)}}{2}.$$

The explicit solution that satisfies the initial condition is then

$$y = -1 - \sqrt{x^4 + 3x^2 + 4}.$$

- (c) From the graph of the function $f(x) = x^4 + 3x^3 + 4$ below we see that $f(x) \leq 0$ on the approximate interval $-2.8 \leq x \leq -1.3$. Thus the approximate domain of the function

$$y = -1 - \sqrt{x^4 + 3x^3 + 4} = -1 - \sqrt{f(x)}$$

is $x \leq -2.8$ or $x \geq -1.3$. The graph of this function is shown below.

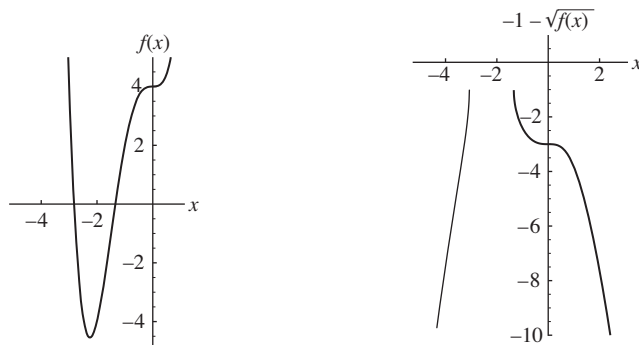

- (d) Using the root finding capabilities of a CAS, the zeros of f are found to be -2.82202 and -1.3409 . The domain of definition of the solution $y(x)$ is then $x > -1.3409$. The equality has been removed since the derivative dy/dx does not exist at the points where $f(x) = 0$. The graph of the solution $y = \phi(x)$ is given on the right.

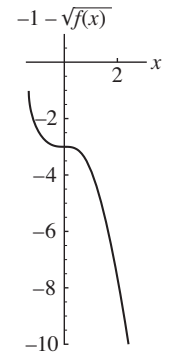

60. (a) Separating variables and integrating, we have

$$(-2y + y^2) dy = (x - x^2) dx$$

and

$$-y^2 + \frac{1}{3}y^3 = \frac{1}{2}x^2 - \frac{1}{3}x^3 + c$$

Using a CAS we show some contours of

$$f(x, y) = 2y^3 - 6y^2 + 2x^3 - 3x^2.$$

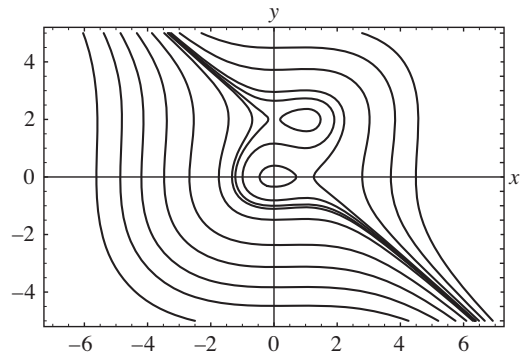

The plots shown on $[-7, 7] \times [-5, 5]$ correspond to c -values of $-450, -300, -200, -120, -60, -20, -10, -8.1, -5, -0.8, 20, 60,$ and 120 .

- (b) The value of c corresponding to $y(0) = \frac{3}{2}$ is $f(0, \frac{3}{2}) = -\frac{27}{4}$. The portion of the graph between the dots corresponds to the solution curve satisfying the initial condition. To determine the interval of definition we find dy/dx for

$$2y^3 - 6y^2 + 2x^3 - 3x^2 = -\frac{27}{4}.$$

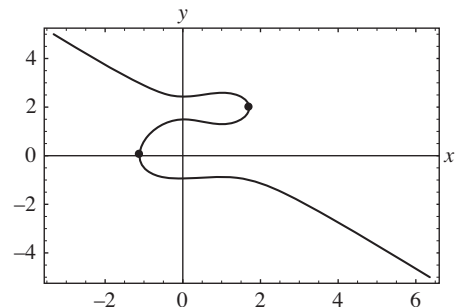

Using implicit differentiation we get $y' = (x - x^2)/(y^2 - 2y)$, which is infinite when $y = 0$ and $y = 2$. Letting $y = 0$ in $2y^3 - 6y^2 + 2x^3 - 3x^2 = -\frac{27}{4}$ and using a CAS to solve for x we get $x = -1.13232$. Similarly, letting $y = 2$, we find $x = 1.71299$. The largest interval of definition is approximately $(-1.13232, 1.71299)$.

- (c) The value of c corresponding to $y(0) = -2$ is $f(0, -2) = -40$. The portion of the graph to the right of the dot corresponds to the solution curve satisfying the initial condition. To determine the interval of definition we find dy/dx for

$$2y^3 - 6y^2 + 2x^3 - 3x^2 = -40.$$

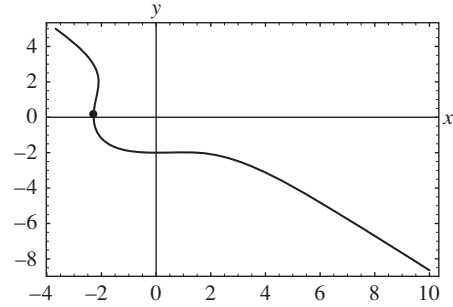

Using implicit differentiation we get $y' = (x - x^2)/(y^2 - 2y)$, which is infinite when $y = 0$ and $y = 2$. Letting $y = 0$ in $2y^3 - 6y^2 + 2x^3 - 3x^2 = -40$ and using a CAS to solve for x we get $x = -2.29551$. The largest interval of definition is approximately $(-2.29551, \infty)$.

2.3 Linear Equations

- For $y' - 5y = 0$ an integrating factor is $e^{-\int 5 dx} = e^{-5x}$ so that $\frac{d}{dx} [e^{-5x}y] = 0$ and $y = ce^{5x}$ for $-\infty < x < \infty$.
- For $y' + 2y = 0$ an integrating factor is $e^{\int 2 dx} = e^{2x}$ so that $\frac{d}{dx} [e^{2x}y] = 0$ and $y = ce^{-2x}$ for $-\infty < x < \infty$. The transient term is ce^{-2x} .
- For $y' + y = e^{3x}$ an integrating factor is $e^{\int dx} = e^x$ so that $\frac{d}{dx} [e^x y] = e^{4x}$ and $y = \frac{1}{4}e^{3x} + ce^{-x}$ for $-\infty < x < \infty$. The transient term is ce^{-x} .
- For $y' + 4y = \frac{4}{3}$ an integrating factor is $e^{\int 4 dx} = e^{4x}$ so that $\frac{d}{dx} [e^{4x}y] = \frac{4}{3}e^{4x}$ and $y = \frac{1}{3} + ce^{-4x}$ for $-\infty < x < \infty$. The transient term is ce^{-4x} .
- For $y' + 3x^2y = x^2$ an integrating factor is $e^{\int 3x^2 dx} = e^{x^3}$ so that $\frac{d}{dx} [e^{x^3}y] = x^2e^{x^3}$ and $y = \frac{1}{3} + ce^{-x^3}$ for $-\infty < x < \infty$. The transient term is ce^{-x^3} .
- For $y' + 2xy = x^3$ an integrating factor is $e^{\int 2x dx} = e^{x^2}$ so that $\frac{d}{dx} [e^{x^2}y] = x^3e^{x^2}$ and $y = \frac{1}{2}x^2 - \frac{1}{2} + ce^{-x^2}$ for $-\infty < x < \infty$. The transient term is ce^{-x^2} .
- For $y' + \frac{1}{x}y = \frac{1}{x^2}$ an integrating factor is $e^{\int (1/x) dx} = x$ so that $\frac{d}{dx} [xy] = \frac{1}{x}$ and $y = \frac{1}{x} \ln x + \frac{c}{x}$ for $0 < x < \infty$. The entire solution is transient.

8. For $y' - 2y = x^2 + 5$ an integrating factor is $e^{-\int 2 dx} = e^{-2x}$ so that $\frac{d}{dx} [e^{-2x}y] = x^2e^{-2x} + 5e^{-2x}$ and $y = -\frac{1}{2}x^2 - \frac{1}{2}x - \frac{11}{4} + ce^{2x}$ for $-\infty < x < \infty$. There is no transient term.
9. For $y' - \frac{1}{x}y = x \sin x$ an integrating factor is $e^{-\int (1/x) dx} = \frac{1}{x}$ so that $\frac{d}{dx} \left[\frac{1}{x}y \right] = \sin x$ and $y = cx - x \cos x$ for $0 < x < \infty$. There is no transient term.
10. For $y' + \frac{2}{x}y = \frac{3}{x}$ an integrating factor is $e^{\int (2/x) dx} = x^2$ so that $\frac{d}{dx} [x^2y] = 3x$ and $y = \frac{3}{2} + cx^{-2}$ for $0 < x < \infty$. The transient term is cx^{-2} .
11. For $y' + \frac{4}{x}y = x^2 - 1$ an integrating factor is $e^{\int (4/x) dx} = x^4$ so that $\frac{d}{dx} [x^4y] = x^6 - x^4$ and $y = \frac{1}{7}x^3 - \frac{1}{5}x + cx^{-4}$ for $0 < x < \infty$. The transient term is cx^{-4} .
12. For $y' - \frac{x}{(1+x)}y = x$ an integrating factor is $e^{-\int [x/(1+x)] dx} = (x+1)e^{-x}$ so that $\frac{d}{dx} [(x+1)e^{-x}y] = x(x+1)e^{-x}$ and $y = -x - \frac{2x+3}{x+1} + \frac{ce^x}{x+1}$ for $-1 < x < \infty$. There is no transient term.
13. For $y' + \left(1 + \frac{2}{x}\right)y = \frac{e^x}{x^2}$ an integrating factor is $e^{\int [1+(2/x)] dx} = x^2e^x$ so that $\frac{d}{dx} [x^2e^xy] = e^{2x}$ and $y = \frac{1}{2} \frac{e^x}{x^2} + \frac{ce^{-x}}{x^2}$ for $0 < x < \infty$. The transient term is $\frac{ce^{-x}}{x^2}$.
14. For $y' + \left(1 + \frac{1}{x}\right)y = \frac{1}{x}e^{-x} \sin 2x$ an integrating factor is $e^{\int [1+(1/x)] dx} = xe^x$ so that $\frac{d}{dx} [xe^xy] = \sin 2x$ and $y = -\frac{1}{2x}e^{-x} \cos 2x + \frac{ce^{-x}}{x}$ for $0 < x < \infty$. The entire solution is transient.
15. For $\frac{dx}{dy} - \frac{4}{y}x = 4y^5$ an integrating factor is $e^{-\int (4/y) dy} = e^{\ln y^{-4}} = y^{-4}$ so that $\frac{d}{dy} [y^{-4}x] = 4y$ and $x = 2y^6 + cy^4$ for $0 < y < \infty$. There is no transient term.
16. For $\frac{dx}{dy} + \frac{2}{y}x = e^y$ an integrating factor is $e^{\int (2/y) dy} = y^2$ so that $\frac{d}{dy} [y^2x] = y^2e^y$ and $x = e^y - \frac{2}{y}e^y + \frac{2}{y^2}e^y + \frac{c}{y^2}$ for $0 < y < \infty$. The transient term is $\frac{c}{y^2}$.

17. For $y' + (\tan x)y = \sec x$ an integrating factor is $e^{\int \tan x dx} = \sec x$ so that $\frac{d}{dx}[(\sec x)y] = \sec^2 x$ and $y = \sin x + c \cos x$ for $-\pi/2 < x < \pi/2$. There is no transient term.
18. For $y' + (\cot x)y = \sec^2 x \csc x$ an integrating factor is $e^{\int \cot x dx} = e^{\ln |\sin x|} = \sin x$ so that $\frac{d}{dx}[(\sin x)y] = \sec^2 x$ and $y = \sec x + c \csc x$ for $0 < x < \pi/2$. There is no transient term.
19. For $y' + \frac{x+2}{x+1}y = \frac{2xe^{-x}}{x+1}$ an integrating factor is $e^{\int [(x+2)/(x+1)]dx} = (x+1)e^x$, so $\frac{d}{dx}[(x+1)e^xy] = 2x$ and $y = \frac{x^2}{x+1}e^{-x} + \frac{c}{x+1}e^{-x}$ for $-1 < x < \infty$. The entire solution is transient.
20. For $y' + \frac{4}{x+2}y = \frac{5}{(x+2)^2}$ an integrating factor is $e^{\int [4/(x+2)]dx} = (x+2)^4$ so that $\frac{d}{dx}[(x+2)^4y] = 5(x+2)^2$ and $y = \frac{5}{3}(x+2)^{-1} + c(x+2)^{-4}$ for $-2 < x < \infty$. The entire solution is transient.
21. For $\frac{dr}{d\theta} + r \sec \theta = \cos \theta$ an integrating factor is $e^{\int \sec \theta d\theta} = e^{\ln |\sec \theta + \tan \theta|} = \sec \theta + \tan \theta$ so that $\frac{d}{d\theta}[(\sec \theta + \tan \theta)r] = 1 + \sin \theta$ and $(\sec \theta + \tan \theta)r = \theta - \cos \theta + c$ for $-\pi/2 < \theta < \pi/2$. There is no transient term.
22. For $\frac{dP}{dt} + (2t-1)P = 4t-2$ an integrating factor is $e^{\int (2t-1)dt} = e^{t^2-t}$ so that $\frac{d}{dt}[e^{t^2-t}P] = (4t-2)e^{t^2-t}$ and $P = 2 + ce^{t-t^2}$ for $-\infty < t < \infty$. The transient term is ce^{t-t^2} .
23. For $y' + \left(3 + \frac{1}{x}\right)y = \frac{e^{-3x}}{x}$ an integrating factor is $e^{\int [3+(1/x)]dx} = xe^{3x}$ so that $\frac{d}{dx}[xe^{3x}y] = 1$ and $y = e^{-3x} + \frac{ce^{-3x}}{x}$ for $0 < x < \infty$. The transient term is ce^{-3x}/x .
24. For $y' + \frac{2}{x^2-1}y = \frac{x+1}{x-1}$ an integrating factor is $e^{\int [2/(x^2-1)]dx} = \frac{x-1}{x+1}$ so that $\frac{d}{dx}\left[\frac{x-1}{x+1}y\right] = 1$ and $(x-1)y = x(x+1) + c(x+1)$ for $-1 < x < 1$. There is no transient term.

25. For $y' - 5y = x$ an integrating factor is $e^{\int -5 dx} = e^{-5x}$ so that $\frac{d}{dx} [e^{-5x}y] = xe^{-5x}$ and

$$y = e^{5x} \int xe^{-5x} dx = e^{5x} \left(-\frac{1}{5}xe^{-5x} - \frac{1}{25}e^{-5x} + c \right) = -\frac{1}{5}x - \frac{1}{25} + ce^{5x}.$$

If $y(0) = 3$ then $c = \frac{1}{25}$ and $y = -\frac{1}{5}x - \frac{1}{25} + \frac{76}{25}e^{5x}$. The solution is defined on $I = (-\infty, \infty)$.

26. For $y' + 3y = 2x$ and integrating factor is $e^{\int 3 dx} = e^{3x}$ so that $\frac{d}{dx} [e^{3x}y] = 2xe^{3x}$ and

$$y = e^{-3x} \int 2xe^{3x} dx = e^{-3x} \left(\frac{2}{3}xe^{3x} - \frac{2}{9}e^{3x} + c \right) = \frac{2}{3}x - \frac{2}{9} + ce^{-3x}.$$

If $y(0) = \frac{1}{3}$ then $c = \frac{5}{9}$ and $y = \frac{2}{3}x - \frac{2}{9} + \frac{5}{9}e^{-3x}$. The solution is defined on $I = (-\infty, \infty)$.

27. For $y' + \frac{1}{x}y = \frac{1}{x}e^x$ an integrating factor is $e^{\int (1/x)dx} = x$ so that $\frac{d}{dx} [xy] = e^x$ and $y = \frac{1}{x}e^x + \frac{c}{x}$ for $0 < x < \infty$. If $y(1) = 2$ then $c = 2 - e$ and $y = \frac{1}{x}e^x + \frac{2-e}{x}$. The solution is defined on $I = (0, \infty)$.

28. For $\frac{dx}{dy} - \frac{1}{y}x = 2y$ an integrating factor is $e^{-\int (1/y)dy} = \frac{1}{y}$ so that $\frac{d}{dy} \left[\frac{1}{y}x \right] = 2$ and $x = 2y^2 + cy$ for $0 < y < \infty$. If $y(1) = 5$ then $c = -49/5$ and $x = 2y^2 - \frac{49}{5}y$. The solution is defined on $I = (0, \infty)$.

29. For $\frac{di}{dt} + \frac{R}{L}i = \frac{E}{L}$ an integrating factor is $e^{\int (R/L)dt} = e^{Rt/L}$ so that $\frac{d}{dt} [e^{Rt/L}i] = \frac{E}{L}e^{Rt/L}$ and $i = \frac{E}{R} + ce^{-Rt/L}$ for $-\infty < t < \infty$. If $i(0) = i_0$ then $c = i_0 - E/R$ and $i = \frac{E}{R} + \left(i_0 - \frac{E}{R} \right) e^{-Rt/L}$. The solution is defined on $I = (-\infty, \infty)$.

30. For $\frac{dT}{dt} - kT = -T_m k$ an integrating factor is $e^{\int (-k)dt} = e^{-kt}$ so that $\frac{d}{dt} [e^{-kt}T] = -T_m k e^{-kt}$ and $T = T_m + ce^{kt}$ for $-\infty < t < \infty$. If $T(0) = T_0$ then $c = T_0 - T_m$ and $T = T_m + (T_0 - T_m)e^{kt}$.

The solution is defined on $I = (-\infty, \infty)$.

31. For $y' + \frac{1}{x}y = 4 + \frac{1}{x}$ an integrating factor is $e^{\int (1/x)dx} = x$ so that $\frac{d}{dx} [xy] = 4x + 1$ and

$$y = \frac{1}{x} \int (4x + 1) dx = \frac{1}{x} (2x^2 + x + c) = 2x + 1 + \frac{c}{x}.$$

If $y(1) = 8$ then $c = 5$ and $y = 2x + 1 + \frac{5}{x}$. The solution is defined on $I = (0, \infty)$.

- 32.** For $y' + 4xy = x^3 e^{3x^2}$ an integrating factor is $e^{\int 4x dx} = e^{2x^2}$ so that $\frac{d}{dx} [e^{2x^2} y] = x^3 e^{3x^2}$ and

$$y = e^{-2x^2} \int x^3 e^{3x^2} dx = e^{-2x^2} \left(\frac{1}{6} x^2 e^{3x^2} - \frac{1}{18} e^{3x^2} + c \right) = \frac{1}{6} x^2 e^{x^2} - \frac{1}{18} e^{x^2} + ce^{-2x^2}.$$

If $y(0) = -1$ then $c = -\frac{17}{18}$ and $y = \frac{1}{6} x^2 e^{x^2} - \frac{1}{18} e^{x^2} - \frac{17}{18} e^{-2x^2}$. The solution is defined on $I = (-\infty, \infty)$.

- 33.** For $y' + \frac{1}{x+1} y = \frac{\ln x}{x+1}$ an integrating factor is $e^{\int [1/(x+1)] dx} = x+1$ so that $\frac{d}{dx} [(x+1)y] = \ln x$ and

$$y = \frac{x}{x+1} \ln x - \frac{x}{x+1} + \frac{c}{x+1} \quad \text{for } 0 < x < \infty.$$

If $y(1) = 10$ then $c = 21$ and $y = \frac{x}{x+1} \ln x - \frac{x}{x+1} + \frac{21}{x+1}$. The solution is defined on $I = (0, \infty)$.

- 34.** For $y' + \frac{1}{x+1} y = \frac{1}{x(x+1)}$ an integrating factor is $e^{\int [1/(x+1)] dx} = x+1$ so that $\frac{d}{dx} [(x+1)y] = \frac{1}{x}$ and

$$y = \frac{1}{x+1} \int \frac{1}{x} dx = \frac{1}{x+1} (\ln x + c) = \frac{\ln x}{x+1} + \frac{c}{x+1}.$$

If $y(e) = 1$ then $c = e$ and $y = \frac{\ln x}{x+1} + \frac{e}{x+1}$. The solution is defined on $I = (0, \infty)$.

- 35.** For $y' - (\sin x)y = 2 \sin x$ an integrating factor is $e^{\int (-\sin x) dx} = e^{\cos x}$ so that $\frac{d}{dx} [e^{\cos x} y] = 2(\sin x) e^{\cos x}$ and

$$y = e^{-\cos x} \int 2(\sin x) e^{\cos x} dx = e^{-\cos x} (-2e^{\cos x} + c) = -2 + ce^{-\cos x}.$$

If $y(\pi/2) = 1$ then $c = 3$ and $y = -2 + 3e^{-\cos x}$. The solution is defined on $I = (-\infty, \infty)$.

36. For $y' + (\tan x)y = \cos^2 x$ an integrating factor is $e^{\int \tan x dx} = e^{\ln|\sec x|} = \sec x$ so that

$$\frac{d}{dx}[(\sec x)y] = \cos x \text{ and } y = \sin x \cos x + c \cos x \text{ for } -\pi/2 < x < \pi/2. \text{ If } y(0) = -1$$

then $c = -1$ and $y = \sin x \cos x - \cos x$. The solution is defined on $I = (-\pi/2, \pi/2)$.

37. For $y' + 2y = f(x)$ an integrating factor is e^{2x} so that

$$ye^{2x} = \begin{cases} \frac{1}{2}e^{2x} + c_1, & 0 \leq x \leq 3 \\ c_2, & x > 3. \end{cases}$$

If $y(0) = 0$ then $c_1 = -1/2$ and for continuity we must have $c_2 = \frac{1}{2}e^6 - \frac{1}{2}$ so that

$$y = \begin{cases} \frac{1}{2}(1 - e^{-2x}), & 0 \leq x \leq 3 \\ \frac{1}{2}(e^6 - 1)e^{-2x}, & x > 3. \end{cases}$$

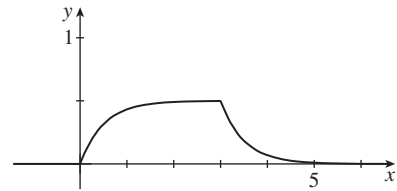

38. For $y' + y = f(x)$ an integrating factor is e^x so that

$$ye^x = \begin{cases} e^x + c_1, & 0 \leq x \leq 1 \\ -e^x + c_2, & x > 1. \end{cases}$$

If $y(0) = 1$ then $c_1 = 0$ and for continuity we must have $c_2 = 2e$ so that

$$y = \begin{cases} 1, & 0 \leq x \leq 1 \\ 2e^{1-x} - 1, & x > 1. \end{cases}$$

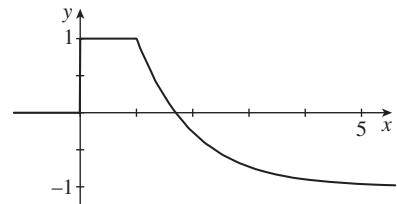

39. For $y' + 2xy = f(x)$ an integrating factor is e^{x^2} so that

$$ye^{x^2} = \begin{cases} \frac{1}{2}e^{x^2} + c_1, & 0 \leq x \leq 1 \\ c_2, & x > 1. \end{cases}$$

If $y(0) = 2$ then $c_1 = 3/2$ and for continuity we must have $c_2 = \frac{1}{2}e + \frac{3}{2}$ so that

$$y = \begin{cases} \frac{1}{2} + \frac{3}{2}e^{-x^2}, & 0 \leq x \leq 1 \\ \left(\frac{1}{2}e + \frac{3}{2}\right)e^{-x^2}, & x > 1. \end{cases}$$

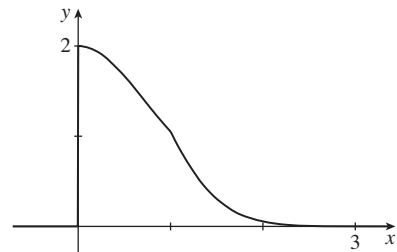

40. For

$$y' + \frac{2x}{1+x^2}y = \begin{cases} \frac{x}{1+x^2}, & 0 \leq x \leq 1 \\ \frac{-x}{1+x^2}, & x > 1, \end{cases}$$

If

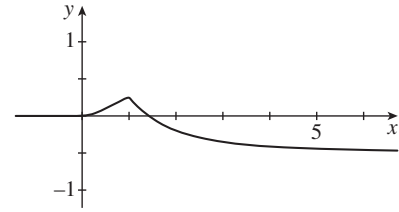
an integrating factor is $1+x^2$ so that

$$(1+x^2)y = \begin{cases} \frac{1}{2}x^2 + c_1, & 0 \leq x \leq 1 \\ -\frac{1}{2}x^2 + c_2, & x > 1. \end{cases}$$

 $y(0) = 0$ then $c_1 = 0$ and for continuity we must have $c_2 = 1$ so that

$$y = \begin{cases} \frac{1}{2} - \frac{1}{2(1+x^2)}, & 0 \leq x \leq 1 \\ \frac{3}{2(1+x^2)} - \frac{1}{2}, & x > 1. \end{cases}$$

41. We first solve the initial-value problem $y' + 2y = 4x$, $y(0) = 3$ on the interval $[0, 1]$. The integrating factor is $e^{\int 2 dx} = e^{2x}$, so

$$\begin{aligned} \frac{d}{dx}[e^{2x}y] &= 4xe^{2x} \\ e^{2x}y &= \int 4xe^{2x} dx = 2xe^{2x} - e^{2x} + c_1 \\ y &= 2x - 1 + c_1e^{-2x}. \end{aligned}$$

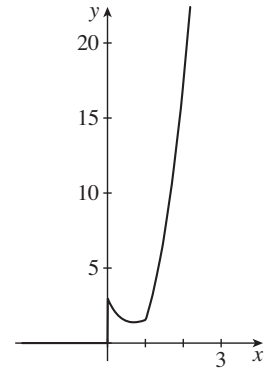
Using the initial condition, we find $y(0) = -1 + c_1 = 3$, so $c_1 = 4$ and $y = 2x - 1 + 4e^{-2x}$, $0 \leq x \leq 1$. Now, since $y(1) = 2 - 1 + 4e^{-2} = 1 + 4e^{-2}$, we solve the initial-value problem $y' - (2/x)y = 4x$, $y(1) = 1 + 4e^{-2}$ on the interval $(1, \infty)$. The integrating factor is $e^{\int (-2/x) dx} = e^{-2 \ln x} = x^{-2}$, so

$$\begin{aligned} \frac{d}{dx}[x^{-2}y] &= 4xx^{-2} = \frac{4}{x} \\ x^{-2}y &= \int \frac{4}{x} dx = 4 \ln x + c_2 \\ y &= 4x^2 \ln x + c_2x^2. \end{aligned}$$

(We use $\ln x$ instead of $\ln |x|$ because $x > 1$.) Using the initial condition we find

$y(1) = c_2 = 1 + 4e^{-2}$, so $y = 4x^2 \ln x + (1 + 4e^{-2})x^2$, $x > 1$. Thus,

$$y = \begin{cases} 2x - 1 + 4e^{-2x}, & 0 \leq x \leq 1 \\ 4x^2 \ln x + (1 + 4e^{-2})x^2, & x > 1. \end{cases}$$

42. We first solve the initial-value problem $y' + y = 0$, $y(0) = 4$ on the interval $[0, 2]$. The integrating factor is $e^{\int 1 dx} = e^x$, so

$$\begin{aligned} \frac{d}{dx}[e^x y] &= 0 \\ e^x y &= \int 0 dx = c_1 \\ y &= c_1 e^{-x}. \end{aligned}$$

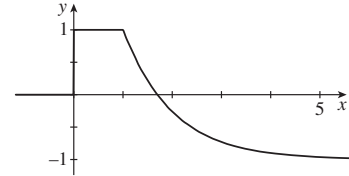

Using the initial condition, we find $y(0) = c_1 = 4$, so $c_1 = 4$ and $y = 4e^{-x}$, $0 \leq x \leq 2$. Now, since $y(2) = 4e^{-2}$, we solve the initial-value problem $y' + 5y = 0$, $y(2) = 4e^{-2}$ on the interval $(2, \infty)$. The integrating factor is $e^{\int 5 dx} = e^{5x}$, so

$$\begin{aligned} \frac{d}{dx}[e^{5x} y] &= 0 \\ e^{5x} y &= \int 0 dx = c_2 \\ y &= c_2 e^{-5x}. \end{aligned}$$

Using the initial condition we find $y(2) = c_2 e^{-10} = 4e^{-2}$, so $c_2 = 4e^8$ and $y = 4e^8 e^{-5x} = 4e^{8-5x}$, $x > 2$. Thus, the solution of the original initial-value problem is

$$y = \begin{cases} 4e^{-x}, & 0 \leq x \leq 2 \\ 4e^{8-5x}, & x > 2. \end{cases}$$

43. An integrating factor for $y' - 2xy = 1$ is e^{-x^2} . Thus

$$\begin{aligned}\frac{d}{dx}[e^{-x^2}y] &= e^{-x^2} \\ e^{-x^2}y &= \int_0^x e^{-t^2} dt = \frac{\sqrt{\pi}}{2} \operatorname{erf}(x) + c \\ y &= \frac{\sqrt{\pi}}{2} e^{x^2} \operatorname{erf}(x) + ce^{x^2}.\end{aligned}$$

From $y(1) = (\sqrt{\pi}/2)e \operatorname{erf}(1) + ce = 1$ we get $c = e^{-1} - \frac{\sqrt{\pi}}{2} \operatorname{erf}(1)$. The solution of the initial-value problem is

$$\begin{aligned}y &= \frac{\sqrt{\pi}}{2} e^{x^2} \operatorname{erf}(x) + \left(e^{-1} - \frac{\sqrt{\pi}}{2} \operatorname{erf}(1) \right) e^{x^2} \\ &= e^{x^2-1} + \frac{\sqrt{\pi}}{2} e^{x^2} (\operatorname{erf}(x) - \operatorname{erf}(1)).\end{aligned}$$

44. An integrating factor for $y' - 2xy = -1$ is e^{-x^2} . Thus

$$\begin{aligned}\frac{d}{dx}[e^{-x^2}y] &= -e^{-x^2} \\ e^{-x^2}y &= -\int_0^x e^{-t^2} dt = -\frac{\sqrt{\pi}}{2} \operatorname{erf}(x) + c.\end{aligned}$$

From $y(0) = \sqrt{\pi}/2$, and noting that $\operatorname{erf}(0) = 0$, we get $c = \sqrt{\pi}/2$. Thus

$$y = e^{x^2} \left(-\frac{\sqrt{\pi}}{2} \operatorname{erf}(x) + \frac{\sqrt{\pi}}{2} \right) = \frac{\sqrt{\pi}}{2} e^{x^2} (1 - \operatorname{erf}(x)) = \frac{\sqrt{\pi}}{2} e^{x^2} \operatorname{erfc}(x).$$

45. For $y' + e^x y = 1$ an integrating factor is e^{e^x} . Thus

$$\frac{d}{dx} [e^{e^x} y] = e^{e^x} \quad \text{and} \quad e^{e^x} y = \int_0^x e^{e^t} dt + c.$$

From $y(0) = 1$ we get $c = e$, so $y = e^{-e^x} \int_0^x e^{e^t} dt + e^{1-e^x}$.

46. Dividing by x^2 we have $y' - \frac{1}{x^2}y = x$. An integrating factor is $e^{1/x}$. Thus

$$\frac{d}{dx} [e^{1/x}y] = xe^{1/x} \quad \text{and} \quad e^{1/x}y = \int_1^x te^{1/t} dt + c.$$

From $y(1) = 0$ we get $c = 0$, so $y = e^{-1/x} \int_1^x te^{1/t} dt$.

47. An integrating factor for

$$y' + \frac{2}{x}y = \frac{10 \sin x}{x^3}$$

is x^2 . Thus

$$\begin{aligned} \frac{d}{dx} [x^2 y] &= 10 \frac{\sin x}{x} \\ x^2 y &= 10 \int_0^x \frac{\sin t}{t} dt + c \\ y &= 10x^{-2} \text{Si}(x) + cx^{-2}. \end{aligned}$$

From $y(1) = 0$ we get $c = -10 \text{Si}(1)$. Thus

$$y = 10x^{-2} \text{Si}(x) - 10x^{-2} \text{Si}(1) = 10x^{-2} (\text{Si}(x) - \text{Si}(1)).$$

48. The integrating factor for $y' - (\sin x^2)y = 0$ is $e^{-\int_0^x \sin t^2 dt}$. Then

$$\begin{aligned} \frac{d}{dx} [e^{-\int_0^x \sin t^2 dt} y] &= 0 \\ e^{-\int_0^x \sin t^2 dt} y &= c_1 \\ y &= c_1 e^{\int_0^x \sin t^2 dt} \end{aligned}$$

Letting $t = \sqrt{\pi/2}u$ we have $dt = \sqrt{\pi/2} du$ and

$$\int_0^x \sin t^2 dt = \sqrt{\frac{\pi}{2}} \int_0^{\sqrt{2/\pi}x} \sin\left(\frac{\pi}{2}u^2\right) du = \sqrt{\frac{\pi}{2}} S\left(\sqrt{\frac{2}{\pi}}x\right)$$

so $y = c_1 e^{\sqrt{\pi/2}S(\sqrt{2/\pi}x)}$. Using $S(0) = 0$ and $y(0) = c_1 = 5$ we have $y = 5e^{\sqrt{\pi/2}S(\sqrt{2/\pi}x)}$.

49. We want 4 to be a critical point, so we use $y' = 4 - y$.

50. (a) All solutions of the form $y = x^5 e^x - x^4 e^x + cx^4$ satisfy the initial condition. In this case, since $4/x$ is discontinuous at $x = 0$, the hypotheses of Theorem 1.2.1 are not satisfied and the initial-value problem does not have a unique solution.

(b) The differential equation has no solution satisfying $y(0) = y_0$, $y_0 > 0$.

(c) In this case, since $x_0 > 0$, Theorem 1.2.1 applies and the initial-value problem has a unique solution given by $y = x^5 e^x - x^4 e^x + cx^4$ where $c = y_0/x_0^4 - x_0 e^{x_0} + e^{x_0}$.

51. On the interval $(-3, 3)$ the integrating factor is

$$e^{\int x dx/(x^2-9)} = e^{-\int x dx/(9-x^2)} = e^{\frac{1}{2} \ln(9-x^2)} = \sqrt{9-x^2}$$

and so

$$\frac{d}{dx} [\sqrt{9-x^2} y] = 0 \quad \text{and} \quad y = \frac{c}{\sqrt{9-x^2}}.$$

52. We want the general solution to be $y = 3x - 5 + ce^{-x}$. (Rather than e^{-x} , any function that approaches 0 as $x \rightarrow \infty$ could be used.) Differentiating we get

$$y' = 3 - ce^{-x} = 3 - (y - 3x + 5) = -y + 3x - 2,$$

so the differential equation $y' + y = 3x - 2$ has solutions asymptotic to the line $y = 3x - 5$.

53. The left-hand derivative of the function at $x = 1$ is $1/e$ and the right-hand derivative at $x = 1$ is $1 - 1/e$. Thus, y is not differentiable at $x = 1$.

54. (a) Differentiating $y_c = c/x^3$ we get

$$y'_c = -\frac{3c}{x^4} = -\frac{3}{x} \frac{c}{x^3} = -\frac{3}{x} y_c$$

so a differential equation with general solution $y_c = c/x^3$ is $xy' + 3y = 0$. Now using

$$y_p = x^3$$

$$xy'_p + 3y_p = x(3x^2) + 3(x^3) = 6x^3$$

so a differential equation with general solution $y = c/x^3 + x^3$ is $xy' + 3y = 6x^3$. This will be a general solution on $(0, \infty)$.

- (b) Since $y(1) = 1^3 - 1/1^3 = 0$, an initial condition is $y(1) = 0$. Since $y(1) = 1^3 + 2/1^3 = 3$, an initial condition is $y(1) = 3$. In each case the interval of definition is $(0, \infty)$. The initial-value problem $xy' + 3y = 6x^3$, $y(0) = 0$ has solution $y = x^3$ for $-\infty < x < \infty$. In the figure the lower curve is the graph of $y(x) = x^3 - 1/x^3$, while the upper curve is the graph of $y = x^3 - 2/x^3$.

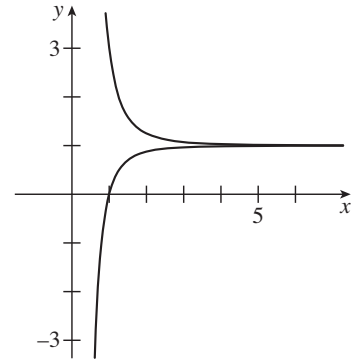

- (c) The first two initial-value problems in part (b) are not unique. For example, setting $y(2) = 2^3 - 1/2^3 = 63/8$, we see that $y(2) = 63/8$ is also an initial condition leading to the solution $y = x^3 - 1/x^3$.

55. Since $e^{\int P(x) dx + c} = e^c e^{\int P(x) dx} = c_1 e^{\int P(x) dx}$, we would have

$$c_1 e^{\int P(x) dx} y = c_2 + \int c_1 e^{\int P(x) dx} f(x) dx \quad \text{and} \quad e^{\int P(x) dx} y = c_3 + \int e^{\int P(x) dx} f(x) dx,$$

which is the same as (4) in the text.

56. We see by inspection that $y = 0$ is a solution.

57. The solution of the first equation is $x = c_1 e^{-\lambda_1 t}$. From $x(0) = x_0$ we obtain $c_1 = x_0$ and so $x = x_0 e^{-\lambda_1 t}$. The second equation then becomes

$$\frac{dy}{dt} = x_0 \lambda_1 e^{-\lambda_1 t} - \lambda_2 y \quad \text{or} \quad \frac{dy}{dt} + \lambda_2 y = x_0 \lambda_1 e^{-\lambda_1 t}$$

which is linear. An integrating factor is $e^{\lambda_2 t}$. Thus

$$\frac{d}{dt} \left[e^{\lambda_2 t} y \right] = x_0 \lambda_1 e^{-\lambda_1 t} e^{\lambda_2 t} = x_0 \lambda_1 e^{(\lambda_2 - \lambda_1)t}$$

$$e^{\lambda_2 t} y = \frac{x_0 \lambda_1}{\lambda_2 - \lambda_1} e^{(\lambda_2 - \lambda_1)t} + c_2$$

$$y = \frac{x_0 \lambda_1}{\lambda_2 - \lambda_1} e^{-\lambda_1 t} + c_2 e^{-\lambda_2 t}.$$

From $y(0) = y_0$ we obtain $c_2 = (y_0\lambda_2 - y_0\lambda_1 - x_0\lambda_1) / (\lambda_2 - \lambda_1)$. The solution is

$$y = \frac{x_0\lambda_1}{\lambda_2 - \lambda_1} e^{-\lambda_1 t} + \frac{y_0\lambda_2 - y_0\lambda_1 - x_0\lambda_1}{\lambda_2 - \lambda_1} e^{-\lambda_2 t}.$$

58. Writing the differential equation as $\frac{dE}{dt} + \frac{1}{RC}E = 0$ we see that an integrating factor is $e^{t/RC}$. Then

$$\frac{d}{dt} [e^{t/RC} E] = 0$$

$$e^{t/RC} E = c$$

$$E = ce^{-t/RC}$$

From $E(4) = ce^{-4/RC} = E_0$ we find $c = E_0 e^{4/RC}$. Thus, the solution of the initial-value problem is

$$E = E_0 e^{4/RC} e^{-t/RC} = E_0 e^{-(t-4)/RC}.$$

59. (a)

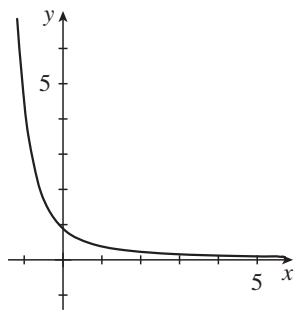

(b) Using a CAS we find $y(2) \approx 0.226339$.

60. (a)

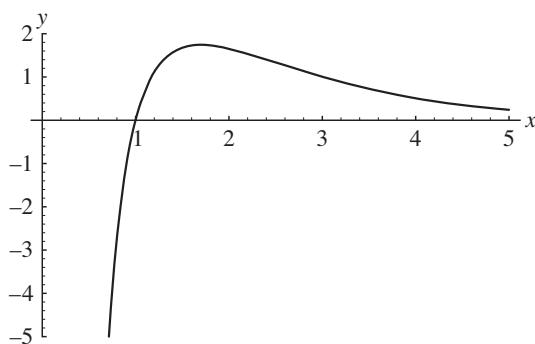

(b) From the graph in part (b) we see that the absolute maximum occurs around $x = 1.7$.

Using the root-finding capability of a CAS and solving $y'(x) = 0$ for x we see that the absolute maximum is $(1.688, 1.742)$.

61. (a)

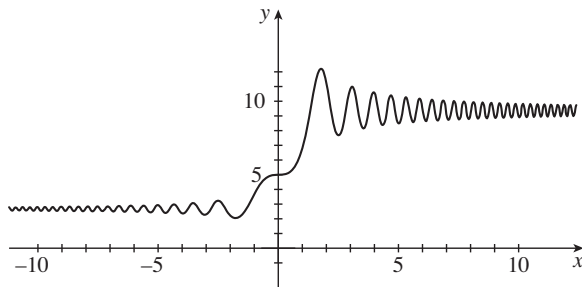

(b) From the graph we see that as $x \rightarrow \infty$, $y(x)$ oscillates with decreasing amplitudes approaching 9.35672. Since $\lim_{x \rightarrow \infty} S(x) = \frac{1}{2}$, we have $\lim_{x \rightarrow \infty} y(x) = 5e^{\sqrt{\pi/8}} \approx 9.357$, and since $\lim_{x \rightarrow -\infty} S(x) = -\frac{1}{2}$, we have $\lim_{x \rightarrow -\infty} y(x) = 5e^{-\sqrt{\pi/8}} \approx 2.672$.

(c) From the graph in part (b) we see that the absolute maximum occurs around $x = 1.7$ and the absolute minimum occurs around $x = -1.8$. Using the root-finding capability of a CAS and solving $y'(x) = 0$ for x , we see that the absolute maximum is $(1.772, 12.235)$ and the absolute minimum is $(-1.772, 2.044)$.

2.4 Exact Equations

- Let $M = 2x - 1$ and $N = 3y + 7$ so that $M_y = 0 = N_x$. From $f_x = 2x - 1$ we obtain $f = x^2 - x + h(y)$, $h'(y) = 3y + 7$, and $h(y) = \frac{3}{2}y^2 + 7y$. A solution is $x^2 - x + \frac{3}{2}y^2 + 7y = c$.
- Let $M = 2x + y$ and $N = -x - 6y$. Then $M_y = 1$ and $N_x = -1$, so the equation is not exact.
- Let $M = 5x + 4y$ and $N = 4x - 8y^3$ so that $M_y = 4 = N_x$. From $f_x = 5x + 4y$ we obtain $f = \frac{5}{2}x^2 + 4xy + h(y)$, $h'(y) = -8y^3$, and $h(y) = -2y^4$. A solution is $\frac{5}{2}x^2 + 4xy - 2y^4 = c$.
- Let $M = \sin y - y \sin x$ and $N = \cos x + x \cos y - y$ so that $M_y = \cos y - \sin x = N_x$. From $f_x = \sin y - y \sin x$ we obtain $f = x \sin y + y \cos x + h(y)$, $h'(y) = -y$, and $h(y) = -\frac{1}{2}y^2$. A solution is $x \sin y + y \cos x - \frac{1}{2}y^2 = c$.

5. Let $M = 2y^2x - 3$ and $N = 2yx^2 + 4$ so that $M_y = 4xy = N_x$. From $f_x = 2y^2x - 3$ we obtain $f = x^2y^2 - 3x + h(y)$, $h'(y) = 4$, and $h(y) = 4y$. A solution is $x^2y^2 - 3x + 4y = c$.
6. Let $M = 4x^3 - 3y \sin 3x - y/x^2$ and $N = 2y - 1/x + \cos 3x$ so that $M_y = -3 \sin 3x - 1/x^2$ and $N_x = 1/x^2 - 3 \sin 3x$. The equation is not exact.
7. Let $M = x^2 - y^2$ and $N = x^2 - 2xy$ so that $M_y = -2y$ and $N_x = 2x - 2y$. The equation is not exact.
8. Let $M = 1 + \ln x + y/x$ and $N = -1 + \ln x$ so that $M_y = 1/x = N_x$. From $f_y = -1 + \ln x$ we obtain $f = -y + y \ln x + h(x)$, $h'(x) = 1 + \ln x$, and $h(x) = x \ln x$. A solution is $-y + y \ln x + x \ln x = c$.
9. Let $M = y^3 - y^2 \sin x - x$ and $N = 3xy^2 + 2y \cos x$ so that $M_y = 3y^2 - 2y \sin x = N_x$. From $f_x = y^3 - y^2 \sin x - x$ we obtain $f = xy^3 + y^2 \cos x - \frac{1}{2}x^2 + h(y)$, $h'(y) = 0$, and $h(y) = 0$. A solution is $xy^3 + y^2 \cos x - \frac{1}{2}x^2 = c$.
10. Let $M = x^3 + y^3$ and $N = 3xy^2$ so that $M_y = 3y^2 = N_x$. From $f_x = x^3 + y^3$ we obtain $f = \frac{1}{4}x^4 + xy^3 + h(y)$, $h'(y) = 0$, and $h(y) = 0$. A solution is $\frac{1}{4}x^4 + xy^3 = c$.
11. Let $M = y \ln y - e^{-xy}$ and $N = 1/y + x \ln y$ so that $M_y = 1 + \ln y + xe^{-xy}$ and $N_x = \ln y$. The equation is not exact.
12. Let $M = 3x^2y + e^y$ and $N = x^3 + xe^y - 2y$ so that $M_y = 3x^2 + e^y = N_x$. From $f_x = 3x^2y + e^y$ we obtain $f = x^3y + xe^y + h(y)$, $h'(y) = -2y$, and $h(y) = -y^2$. A solution is $x^3y + xe^y - y^2 = c$.
13. Let $M = y - 6x^2 - 2xe^x$ and $N = x$ so that $M_y = 1 = N_x$. From $f_x = y - 6x^2 - 2xe^x$ we obtain $f = xy - 2x^3 - 2xe^x + 2e^x + h(y)$, $h'(y) = 0$, and $h(y) = 0$. A solution is $xy - 2x^3 - 2xe^x + 2e^x = c$.
14. Let $M = 1 - 3/x + y$ and $N = 1 - 3/y + x$ so that $M_y = 1 = N_x$. From $f_x = 1 - 3/x + y$ we obtain $f = x - 3 \ln |x| + xy + h(y)$, $h'(y) = 1 - \frac{3}{y}$, and $h(y) = y - 3 \ln |y|$. A solution is $x + y + xy - 3 \ln |xy| = c$.
15. Let $M = x^2y^3 - 1/(1 + 9x^2)$ and $N = x^3y^2$ so that $M_y = 3x^2y^2 = N_x$. From $f_x = x^2y^3 - 1/(1 + 9x^2)$ we obtain $f = \frac{1}{3}x^3y^3 - \frac{1}{3} \arctan(3x) + h(y)$, $h'(y) = 0$, and $h(y) = 0$. A solution is $x^3y^3 - \arctan(3x) = c$.
16. Let $M = -2y$ and $N = 5y - 2x$ so that $M_y = -2 = N_x$. From $f_x = -2y$ we obtain $f = -2xy + h(y)$, $h'(y) = 5y$, and $h(y) = \frac{5}{2}y^2$. A solution is $-2xy + \frac{5}{2}y^2 = c$.
17. Let $M = \tan x - \sin x \sin y$ and $N = \cos x \cos y$ so that $M_y = -\sin x \cos y = N_x$. From $f_x = \tan x - \sin x \sin y$ we obtain $f = \ln |\sec x| + \cos x \sin y + h(y)$, $h'(y) = 0$, and $h(y) = 0$. A solution is $\ln |\sec x| + \cos x \sin y = c$.

18. Let $M = 2y \sin x \cos x - y + 2y^2 e^{xy^2}$ and $N = -x + \sin^2 x + 4xye^{xy^2}$ so that

$$M_y = 2 \sin x \cos x - 1 + 4xy^3 e^{xy^2} + 4ye^{xy^2} = N_x.$$

From $f_x = 2y \sin x \cos x - y + 2y^2 e^{xy^2}$ we obtain $f = y \sin^2 x - xy + 2e^{xy^2} + h(y)$, $h'(y) = 0$, and $h(y) = 0$. A solution is $y \sin^2 x - xy + 2e^{xy^2} = c$.

19. Let $M = 4t^3 y - 15t^2 - y$ and $N = t^4 + 3y^2 - t$ so that $M_y = 4t^3 - 1 = N_t$. From $f_t = 4t^3 y - 15t^2 - y$ we obtain $f = t^4 y - 5t^3 - ty + h(y)$, $h'(y) = 3y^2$, and $h(y) = y^3$. A solution is $t^4 y - 5t^3 - ty + y^3 = c$.

20. Let $M = 1/t + 1/t^2 - y/(t^2 + y^2)$ and $N = ye^y + t/(t^2 + y^2)$ so that $M_y = (y^2 - t^2)/(t^2 + y^2)^2 = N_t$. From $f_t = 1/t + 1/t^2 - y/(t^2 + y^2)$ we obtain $f = \ln|t| - \frac{1}{t} - \arctan\left(\frac{t}{y}\right) + h(y)$, $h'(y) = ye^y$, and $h(y) = ye^y - e^y$. A solution is

$$\ln|t| - \frac{1}{t} - \arctan\left(\frac{t}{y}\right) + ye^y - e^y = c.$$

21. Let $M = x^2 + 2xy + y^2$ and $N = 2xy + x^2 - 1$ so that $M_y = 2(x + y) = N_x$. From $f_x = x^2 + 2xy + y^2$ we obtain $f = \frac{1}{3}x^3 + x^2 y + xy^2 + h(y)$, $h'(y) = -1$, and $h(y) = -y$. The solution is $\frac{1}{3}x^3 + x^2 y + xy^2 - y = c$. If $y(1) = 1$ then $c = 4/3$ and a solution of the initial-value problem is $\frac{1}{3}x^3 + x^2 y + xy^2 - y = \frac{4}{3}$.

22. Let $M = e^x + y$ and $N = 2 + x + ye^y$ so that $M_y = 1 = N_x$. From $f_x = e^x + y$ we obtain $f = e^x + xy + h(y)$, $h'(y) = 2 + ye^y$, and $h(y) = 2y + ye^y - e^y$. The solution is $e^x + xy + 2y + ye^y - e^y = c$. If $y(0) = 1$ then $c = 3$ and a solution of the initial-value problem is $e^x + xy + 2y + ye^y - e^y = 3$.

23. Let $M = 4y + 2t - 5$ and $N = 6y + 4t - 1$ so that $M_y = 4 = N_t$. From $f_t = 4y + 2t - 5$ we obtain $f = 4ty + t^2 - 5t + h(y)$, $h'(y) = 6y - 1$, and $h(y) = 3y^2 - y$. The solution is $4ty + t^2 - 5t + 3y^2 - y = c$. If $y(-1) = 2$ then $c = 8$ and a solution of the initial-value problem is $4ty + t^2 - 5t + 3y^2 - y = 8$.

24. Let $M = t/2y^4$ and $N = (3y^2 - t^2)/y^5$ so that $M_y = -2t/y^5 = N_t$. From $f_t = t/2y^4$ we obtain $f = \frac{t^2}{4y^4} + h(y)$, $h'(y) = \frac{3}{y^3}$, and $h(y) = -\frac{3}{2y^2}$. The solution is $\frac{t^2}{4y^4} - \frac{3}{2y^2} = c$. If $y(1) = 1$ then $c = -5/4$ and a solution of the initial-value problem is $\frac{t^2}{4y^4} - \frac{3}{2y^2} = -\frac{5}{4}$.

25. Let $M = y^2 \cos x - 3x^2 y - 2x$ and $N = 2y \sin x - x^3 + \ln y$ so that $M_y = 2y \cos x - 3x^2 = N_x$. From $f_x = y^2 \cos x - 3x^2 y - 2x$ we obtain $f = y^2 \sin x - x^3 y - x^2 + h(y)$, $h'(y) = \ln y$, and $h(y) = y \ln y - y$. The solution is $y^2 \sin x - x^3 y - x^2 + y \ln y - y = c$. If $y(0) = e$ then $c = 0$ and a solution of the initial-value problem is $y^2 \sin x - x^3 y - x^2 + y \ln y - y = 0$.

26. Let $M = y^2 + y \sin x$ and $N = 2xy - \cos x - 1/(1 + y^2)$ so that $M_y = 2y + \sin x = N_x$. From $f_x = y^2 + y \sin x$ we obtain $f = xy^2 - y \cos x + h(y)$, $h'(y) = \frac{-1}{1 + y^2}$, and $h(y) = -\tan^{-1} y$.

The solution is $xy^2 - y \cos x - \tan^{-1} y = c$. If $y(0) = 1$ then $c = -1 - \pi/4$ and a solution of the initial-value problem is $xy^2 - y \cos x - \tan^{-1} y = -1 - \frac{\pi}{4}$.

- 27.** Equating $M_y = 3y^2 + 4kxy^3$ and $N_x = 3y^2 + 40xy^3$ we obtain $k = 10$.
- 28.** Equating $M_y = 18xy^2 - \sin y$ and $N_x = 4kxy^2 - \sin y$ we obtain $k = 9/2$.
- 29.** Let $M = -x^2y^2 \sin x + 2xy^2 \cos x$ and $N = 2x^2y \cos x$ so that $M_y = -2x^2y \sin x + 4xy \cos x = N_x$. From $f_y = 2x^2y \cos x$ we obtain $f = x^2y^2 \cos x + h(y)$, $h'(y) = 0$, and $h(y) = 0$. A solution of the differential equation is $x^2y^2 \cos x = c$.
- 30.** Let $M = (x^2 + 2xy - y^2)/(x^2 + 2xy + y^2)$ and $N = (y^2 + 2xy - x^2)/(y^2 + 2xy + x^2)$ so that $M_y = -4xy/(x + y)^3 = N_x$. From $f_x = (x^2 + 2xy + y^2 - 2y^2)/(x + y)^2$ we obtain $f = x + \frac{2y^2}{x + y} + h(y)$, $h'(y) = -1$, and $h(y) = -y$. A solution of the differential equation is $x^2 + y^2 = c(x + y)$.
- 31.** We note that $(M_y - N_x)/N = 1/x$, so an integrating factor is $e^{\int dx/x} = x$. Let $M = 2xy^2 + 3x^2$ and $N = 2x^2y$ so that $M_y = 4xy = N_x$. From $f_x = 2xy^2 + 3x^2$ we obtain $f = x^2y^2 + x^3 + h(y)$, $h'(y) = 0$, and $h(y) = 0$. A solution of the differential equation is $x^2y^2 + x^3 = c$.
- 32.** We note that $(M_y - N_x)/N = 1$, so an integrating factor is $e^{\int dx} = e^x$. Let $M = xye^x + y^2e^x + ye^x$ and $N = xe^x + 2ye^x$ so that $M_y = xe^x + 2ye^x + e^x = N_x$. From $f_y = xe^x + 2ye^x$ we obtain $f = xye^x + y^2e^x + h(x)$, $h'(x) = 0$, and $h(x) = 0$. A solution of the differential equation is $xye^x + y^2e^x = c$.
- 33.** We note that $(N_x - M_y)/M = 2/y$, so an integrating factor is $e^{\int 2 dy/y} = y^2$. Let $M = 6xy^3$ and $N = 4y^3 + 9x^2y^2$ so that $M_y = 18xy^2 = N_x$. From $f_x = 6xy^3$ we obtain $f = 3x^2y^3 + h(y)$, $h'(y) = 4y^3$, and $h(y) = y^4$. A solution of the differential equation is $3x^2y^3 + y^4 = c$.
- 34.** We note that $(M_y - N_x)/N = -\cot x$, so an integrating factor is $e^{-\int \cot x dx} = \csc x$. Let $M = \cos x \csc x = \cot x$ and $N = (1 + 2/y) \sin x \csc x = 1 + 2/y$, so that $M_y = 0 = N_x$. From $f_x = \cot x$ we obtain $f = \ln(\sin x) + h(y)$, $h'(y) = 1 + 2/y$, and $h(y) = y + \ln y^2$. A solution of the differential equation is $\ln(\sin x) + y + \ln y^2 = c$.
- 35.** We note that $(M_y - N_x)/N = 3$, so an integrating factor is $e^{\int 3 dx} = e^{3x}$. Let $M = (10 - 6y + e^{-3x})e^{3x} = 10e^{3x} - 6ye^{3x} + 1$ and $N = -2e^{3x}$, so that $M_y = -6e^{3x} = N_x$. From $f_x = 10e^{3x} - 6ye^{3x} + 1$ we obtain $f = \frac{10}{3}e^{3x} - 2ye^{3x} + x + h(y)$, $h'(y) = 0$, and $h(y) = 0$. A solution of the differential equation is $\frac{10}{3}e^{3x} - 2ye^{3x} + x = c$.
- 36.** We note that $(N_x - M_y)/M = -3/y$, so an integrating factor is $e^{-3 \int dy/y} = 1/y^3$. Let $M = (y^2 + xy^3)/y^3 = 1/y + x$ and $N = (5y^2 - xy + y^3 \sin y)/y^3 = 5/y - x/y^2 + \sin y$, so that $M_y = -1/y^2 = N_x$. From $f_x = 1/y + x$ we obtain $f = x/y + \frac{1}{2}x^2 + h(y)$, $h'(y) = 5/y + \sin y$, and $h(y) = 5 \ln |y| - \cos y$. A solution of the differential equation is $x/y + \frac{1}{2}x^2 + 5 \ln |y| - \cos y = c$.

- 37.** We note that $(M_y - N_x)/N = 2x/(4 + x^2)$, so an integrating factor is $e^{-2 \int x dx/(4+x^2)} = 1/(4 + x^2)$. Let $M = x/(4 + x^2)$ and $N = (x^2y + 4y)/(4 + x^2) = y$, so that $M_y = 0 = N_x$. From $f_x = x/(4 + x^2)$ we obtain $f = \frac{1}{2} \ln(4 + x^2) + h(y)$, $h'(y) = y$, and $h(y) = \frac{1}{2}y^2$. A solution of the differential equation is $\frac{1}{2} \ln(4 + x^2) + \frac{1}{2}y^2 = c$. Multiplying both sides by 2 the last equation can be written as $e^{y^2} (x^2 + 4) = c_1$. Using the initial condition $y(4) = 0$ we see that $c_1 = 20$. A solution of the initial-value problem is $e^{y^2} (x^2 + 4) = 20$.
- 38.** We note that $(M_y - N_x)/N = -3/(1+x)$, so an integrating factor is $e^{-3 \int dx/(1+x)} = 1/(1+x)^3$. Let $M = (x^2 + y^2 - 5)/(1+x)^3$ and $N = -(y + xy)/(1+x)^3 = -y/(1+x)^2$, so that $M_y = 2y/(1+x)^3 = N_x$. From $f_y = -y/(1+x)^2$ we obtain $f = -\frac{1}{2}y^2/(1+x)^2 + h(x)$, $h'(x) = (x^2 - 5)/(1+x)^3$, and $h(x) = 2/(1+x)^2 + 2/(1+x) + \ln|1+x|$. A solution of the differential equation is

$$-\frac{y^2}{2(1+x)^2} + \frac{2}{(1+x)^2} + \frac{2}{1+x} + \ln|1+x| = c.$$

Using the initial condition $y(0) = 1$ we see that $c = 7/2$. A solution of the initial-value problem is

$$-\frac{y^2}{2(1+x)^2} + \frac{2}{(1+x)^2} + \frac{2}{1+x} + \ln|1+x| = \frac{7}{2}$$

- 39. (a)** Implicitly differentiating $x^3 + 2x^2y + y^2 = c$ and solving for dy/dx we obtain

$$3x^2 + 2x^2 \frac{dy}{dx} + 4xy + 2y \frac{dy}{dx} = 0 \quad \text{and} \quad \frac{dy}{dx} = -\frac{3x^2 + 4xy}{2x^2 + 2y}.$$

By writing the last equation in differential form we get $(4xy + 3x^2)dx + (2y + 2x^2)dy = 0$.

- (b)** Setting $x = 0$ and $y = -2$ in $x^3 + 2x^2y + y^2 = c$ we find $c = 4$, and setting $x = y = 1$ we also find $c = 4$. Thus, both initial conditions determine the same implicit solution.

- (c)** Solving $x^3 + 2x^2y + y^2 = 4$ for y we get

$$y_1(x) = -x^2 - \sqrt{4 - x^3 + x^4}$$

and

$$y_2(x) = -x^2 + \sqrt{4 - x^3 + x^4}.$$

Observe in the figure that $y_1(0) = -2$ and $y_2(1) = 1$.

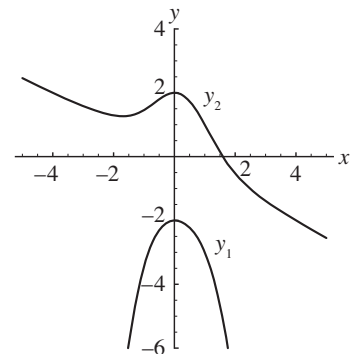

- 40.** To see that the equations are not equivalent consider $dx = -(x/y) dy$. An integrating factor is $\mu(x, y) = y$ resulting in $y dx + x dy = 0$. A solution of the latter equation is $y = 0$, but this is not a solution of the original equation.

41. The explicit solution is $y = \sqrt{(3 + \cos^2 x)/(1 - x^2)}$. Since $3 + \cos^2 x > 0$ for all x we must have $1 - x^2 > 0$ or $-1 < x < 1$. Thus, the interval of definition is $(-1, 1)$.

42. (a) Since $f_y = N(x, y) = xe^{xy} + 2xy + 1/x$ we obtain $f = e^{xy} + xy^2 + \frac{y}{x} + h(x)$ so that $f_x = ye^{xy} + y^2 - \frac{y}{x^2} + h'(x)$. Let $M(x, y) = ye^{xy} + y^2 - \frac{y}{x^2}$.

(b) Since $f_x = M(x, y) = y^{1/2}x^{-1/2} + x(x^2 + y)^{-1}$ we obtain $f = 2y^{1/2}x^{1/2} + \frac{1}{2} \ln|x^2 + y| + g(y)$ so that $f_y = y^{-1/2}x^{1/2} + \frac{1}{2}(x^2 + y)^{-1} + g'(y)$. Let $N(x, y) = y^{-1/2}x^{1/2} + \frac{1}{2}(x^2 + y)^{-1}$.

43. First note that

$$d\left(\sqrt{x^2 + y^2}\right) = \frac{x}{\sqrt{x^2 + y^2}} dx + \frac{y}{\sqrt{x^2 + y^2}} dy.$$

Then $x dx + y dy = \sqrt{x^2 + y^2} dx$ becomes

$$\frac{x}{\sqrt{x^2 + y^2}} dx + \frac{y}{\sqrt{x^2 + y^2}} dy = d\left(\sqrt{x^2 + y^2}\right) = dx.$$

The left side is the total differential of $\sqrt{x^2 + y^2}$ and the right side is the total differential of $x + c$. Thus $\sqrt{x^2 + y^2} = x + c$ is a solution of the differential equation.

44. To see that the statement is true, write the separable equation as $-g(x) dx + dy/h(y) = 0$. Identifying $M = -g(x)$ and $N = 1/h(y)$, we see that $M_y = 0 = N_x$, so the differential equation is exact.

45. (a) In differential form

$$(v^2 - 32x) dx + xv dv = 0$$

This is not an exact equation, but $\mu(x) = x$ is an integrating factor. The new equation $(xv^2 - 32x^2) dx + x^2v dv = 0$ is exact and solving yields $\frac{1}{2}x^2v^2 - \frac{32}{3}x^3 = c$. When $x = 3$, $v = 0$ and so $c = -288$. Solving $\frac{1}{2}x^2v^2 - \frac{32}{3}x^3 = -288$ for v yields the explicit solution

$$v(x) = 8\sqrt{\frac{x}{3} - \frac{9}{x^2}}.$$

(b) The chain leaves the platform when $x = 8$, and so

$$v(8) = 8\sqrt{\frac{8}{3} - \frac{9}{64}} \approx 12.7 \text{ ft/s}$$

46. (a) Letting

$$M(x, y) = \frac{2xy}{(x^2 + y^2)^2} \quad \text{and} \quad N(x, y) = 1 + \frac{y^2 - x^2}{(x^2 + y^2)^2}$$

we compute

$$M_y = \frac{2x^3 - 8xy^2}{(x^2 + y^2)^3} = N_x,$$

so the differential equation is exact. Then we have

$$\begin{aligned}\frac{\partial f}{\partial x} &= M(x, y) = \frac{2xy}{(x^2 + y^2)^2} = 2xy(x^2 + y^2)^{-2} \\ f(x, y) &= -y(x^2 + y^2)^{-1} + g(y) = -\frac{y}{x^2 + y^2} + g(y) \\ \frac{\partial f}{\partial y} &= \frac{y^2 - x^2}{(x^2 + y^2)^2} + g'(y) = N(x, y) = 1 + \frac{y^2 - x^2}{(x^2 + y^2)^2}.\end{aligned}$$

Thus, $g'(y) = 1$ and $g(y) = y$. The solution is $y - \frac{y}{x^2 + y^2} = c$. When $c = 0$ the solution is $x^2 + y^2 = 1$.

(b) The first graph below is obtained in *Mathematica* using $f(x, y) = y - y/(x^2 + y^2)$ and

```
ContourPlot[f[x, y], {x, -3, 3}, {y, -3, 3},
  Axes->True, AxesOrigin->{0, 0}, AxesLabel->{x, y},
  Frame->False, PlotPoints->100, ContourShading->False,
  Contours->{0, -0.2, 0.2, -0.4, 0.4, -0.6, 0.6, -0.8, 0.8}]
```

The second graph uses

$$x = -\sqrt{\frac{y^3 - cy^2 - y}{c - y}} \quad \text{and} \quad x = \sqrt{\frac{y^3 - cy^2 - y}{c - y}}.$$

In this case the x -axis is vertical and the y -axis is horizontal. To obtain the third graph, we solve $y - y/(x^2 + y^2) = c$ for y in a CAS. This appears to give one real and two complex solutions. When graphed in *Mathematica* however, all three solutions contribute to the graph. This is because the solutions involve the square root of expressions containing c . For some values of c the expression is negative, causing an apparent complex solution to actually be real.

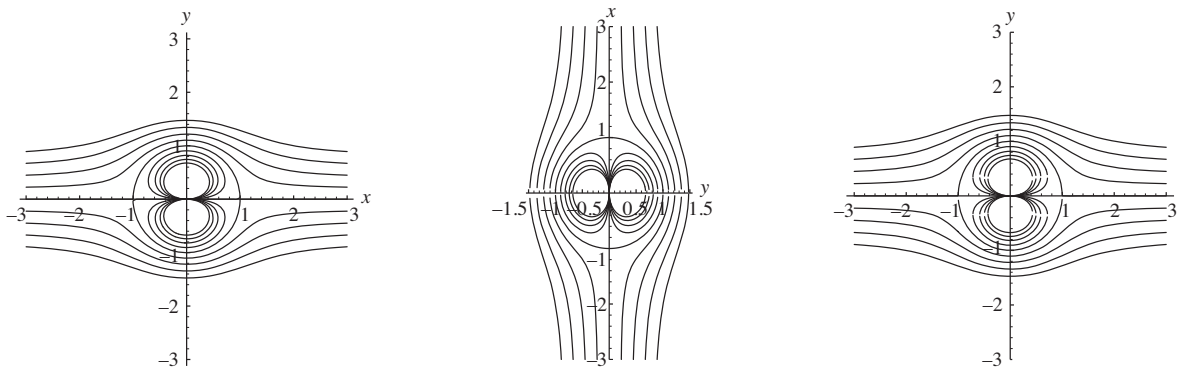

2.5 Solutions by Substitutions

1. Letting $y = ux$ we have

$$\begin{aligned}(x - ux) dx + x(u dx + x du) &= 0 \\ dx + x du &= 0 \\ \frac{dx}{x} + du &= 0 \\ \ln|x| + u &= c \\ x \ln|x| + y &= cx.\end{aligned}$$

2. Letting $y = ux$ we have

$$\begin{aligned}(x + ux) dx + x(u dx + x du) &= 0 \\ (1 + 2u) dx + x du &= 0 \\ \frac{dx}{x} + \frac{du}{1 + 2u} &= 0 \\ \ln|x| + \frac{1}{2} \ln|1 + 2u| &= c \\ x^2 \left(1 + 2\frac{y}{x}\right) &= c_1 \\ x^2 + 2xy &= c_1.\end{aligned}$$

3. Letting $x = vy$ we have

$$\begin{aligned}vy(v dy + y dv) + (y - 2vy) dy &= 0 \\ vy^2 dv + y(v^2 - 2v + 1) dy &= 0 \\ \frac{v dv}{(v - 1)^2} + \frac{dy}{y} &= 0 \\ \ln|v - 1| - \frac{1}{v - 1} + \ln|y| &= c \\ \ln\left|\frac{x}{y} - 1\right| - \frac{1}{x/y - 1} + \ln|y| &= c \\ (x - y) \ln|x - y| - y &= c(x - y).\end{aligned}$$

4. Letting $x = vy$ we have

$$y(v dy + y dv) - 2(vy + y) dy = 0$$

$$y dv - (v + 2) dy = 0$$

$$\frac{dv}{v + 2} - \frac{dy}{y} = 0$$

$$\ln |v + 2| - \ln |y| = c$$

$$\ln \left| \frac{x}{y} + 2 \right| - \ln |y| = c$$

$$x + 2y = c_1 y^2.$$

5. Letting $y = ux$ we have

$$(u^2 x^2 + ux^2) dx - x^2(u dx + x du) = 0$$

$$u^2 dx - x du = 0$$

$$\frac{dx}{x} - \frac{du}{u^2} = 0$$

$$\ln |x| + \frac{1}{u} = c$$

$$\ln |x| + \frac{x}{y} = c$$

$$y \ln |x| + x = cy.$$

6. Letting $y = ux$ and using partial fractions, we have

$$(u^2 x^2 + ux^2) dx + x^2(u dx + x du) = 0$$

$$x^2 (u^2 + 2u) dx + x^3 du = 0$$

$$\frac{dx}{x} + \frac{du}{u(u + 2)} = 0$$

$$\ln |x| + \frac{1}{2} \ln |u| - \frac{1}{2} \ln |u + 2| = c$$

$$\frac{x^2 u}{u + 2} = c_1$$

$$x^2 \frac{y}{x} = c_1 \left(\frac{y}{x} + 2 \right)$$

$$x^2 y = c_1 (y + 2x).$$

7. Letting $y = ux$ we have

$$(ux - x) dx - (ux + x)(u dx + x du) = 0$$

$$(u^2 + 1) dx + x(u + 1) du = 0$$

$$\frac{dx}{x} + \frac{u + 1}{u^2 + 1} du = 0$$

$$\ln |x| + \frac{1}{2} \ln(u^2 + 1) + \tan^{-1} u = c$$

$$\ln x^2 \left(\frac{y^2}{x^2} + 1 \right) + 2 \tan^{-1} \frac{y}{x} = c_1$$

$$\ln(x^2 + y^2) + 2 \tan^{-1} \frac{y}{x} = c_1$$

8. Letting $y = ux$ we have

$$(x + 3ux) dx - (3x + ux)(u dx + x du) = 0$$

$$(u^2 - 1) dx + x(u + 3) du = 0$$

$$\frac{dx}{x} + \frac{u + 3}{(u - 1)(u + 1)} du = 0$$

$$\ln |x| + 2 \ln |u - 1| - \ln |u + 1| = c$$

$$\frac{x(u - 1)^2}{u + 1} = c_1$$

$$x \left(\frac{y}{x} - 1 \right)^2 = c_1 \left(\frac{y}{x} + 1 \right)$$

$$(y - x)^2 = c_1(y + x).$$

9. Letting $y = ux$ we have

$$-ux dx + (x + \sqrt{u}x)(u dx + x du) = 0$$

$$(x^2 + x^2\sqrt{u}) du + xu^{3/2} dx = 0$$

$$\left(u^{-3/2} + \frac{1}{u} \right) du + \frac{dx}{x} = 0$$

$$-2u^{-1/2} + \ln |u| + \ln |x| = c$$

$$\ln |y/x| + \ln |x| = 2\sqrt{x/y} + c$$

$$y(\ln |y| - c)^2 = 4x.$$

10. Letting $y = ux$ we have

$$\begin{aligned}\sqrt{x^2 - u^2x^2} dx - x^2 du &= 0 \\ x\sqrt{1 - u^2} dx - x^2 du &= 0, \quad (x > 0) \\ \frac{dx}{x} - \frac{du}{\sqrt{1 - u^2}} &= 0 \\ \ln x - \sin^{-1} u &= c \\ \sin^{-1} u &= \ln x + c_1 \\ \sin^{-1} \frac{y}{x} &= \ln x + c_2 \\ \frac{y}{x} &= \sin(\ln x + c_2) \\ y &= x \sin(\ln x + c_2).\end{aligned}$$

See Problem 33 in this section for an analysis of the solution.

11. Letting $y = ux$ we have

$$\begin{aligned}(x^3 - u^3x^3) dx + u^2x^3(u dx + x du) &= 0 \\ dx + u^2x du &= 0 \\ \frac{dx}{x} + u^2 du &= 0 \\ \ln|x| + \frac{1}{3}u^3 &= c \\ 3x^3 \ln|x| + y^3 &= c_1x^3.\end{aligned}$$

Using $y(1) = 2$ we find $c_1 = 8$. The solution of the initial-value problem is $3x^3 \ln|x| + y^3 = 8x^3$.

12. Letting $y = ux$ we have

$$\begin{aligned}(x^2 + 2u^2x^2)dx - ux^2(u dx + x du) &= 0 \\ x^2(1 + u^2)dx - ux^3 du &= 0 \\ \frac{dx}{x} - \frac{u du}{1 + u^2} &= 0 \\ \ln|x| - \frac{1}{2}\ln(1 + u^2) &= c \\ \frac{x^2}{1 + u^2} &= c_1 \\ x^4 &= c_1(x^2 + y^2).\end{aligned}$$

Using $y(-1) = 1$ we find $c_1 = 1/2$. The solution of the initial-value problem is $2x^4 = y^2 + x^2$.

13. Letting $y = ux$ we have

$$(x + uxe^u) dx - xe^u(u dx + x du) = 0$$

$$dx - xe^u du = 0$$

$$\frac{dx}{x} - e^u du = 0$$

$$\ln|x| - e^u = c$$

$$\ln|x| - e^{y/x} = c.$$

Using $y(1) = 0$ we find $c = -1$. The solution of the initial-value problem is $\ln|x| = e^{y/x} - 1$.

14. Letting $x = vy$ we have

$$y(v dy + y dv) + vy(\ln vy - \ln y - 1) dy = 0$$

$$y dv + v \ln v dy = 0$$

$$\frac{dv}{v \ln v} + \frac{dy}{y} = 0$$

$$\ln|\ln|v|| + \ln|y| = c$$

$$y \ln \left| \frac{x}{y} \right| = c_1.$$

Using $y(1) = e$ we find $c_1 = -e$. The solution of the initial-value problem is $y \ln \left| \frac{x}{y} \right| = -e$.

15. From $y' + \frac{1}{x}y = \frac{1}{x}y^{-2}$ and $w = y^3$ we obtain $\frac{dw}{dx} + \frac{3}{x}w = \frac{3}{x}$. An integrating factor is x^3 so that $x^3w = x^3 + c$ or $y^3 = 1 + cx^{-3}$.

16. From $y' - y = e^xy^2$ and $w = y^{-1}$ we obtain $\frac{dw}{dx} + w = -e^x$. An integrating factor is e^x so that $e^xw = -\frac{1}{2}e^{2x} + c$ or $y^{-1} = -\frac{1}{2}e^x + ce^{-x}$.

17. From $y' + y = xy^4$ and $w = y^{-3}$ we obtain $\frac{dw}{dx} - 3w = -3x$. An integrating factor is e^{-3x} so that $e^{-3x}w = xe^{-3x} + \frac{1}{3}e^{-3x} + c$ or $y^{-3} = x + \frac{1}{3} + ce^{3x}$.

18. From $y' - \left(1 + \frac{1}{x}\right)y = y^2$ and $w = y^{-1}$ we obtain $\frac{dw}{dx} + \left(1 + \frac{1}{x}\right)w = -1$. An integrating factor is xe^x so that $xe^xw = -xe^x + e^x + c$ or $y^{-1} = -1 + \frac{1}{x} + \frac{c}{x}e^{-x}$.

19. From $y' - \frac{1}{t}y = -\frac{1}{t^2}y^2$ and $w = y^{-1}$ we obtain $\frac{dw}{dt} + \frac{1}{t}w = \frac{1}{t^2}$. An integrating factor is t so that $tw = \ln t + c$ or $y^{-1} = \frac{1}{t} \ln t + \frac{c}{t}$. Writing this in the form $\frac{t}{y} = \ln t + c$, we see that the solution can also be expressed in the form $e^{t/y} = c_1t$.

20. From $y' + \frac{2}{3(1+t^2)}y = \frac{2t}{3(1+t^2)}y^4$ and $w = y^{-3}$ we obtain $\frac{dw}{dt} - \frac{2t}{1+t^2}w = \frac{-2t}{1+t^2}$. An integrating factor is $\frac{1}{1+t^2}$ so that $\frac{w}{1+t^2} = \frac{1}{1+t^2} + c$ or $y^{-3} = 1 + c(1+t^2)$.
21. From $y' - \frac{2}{x}y = \frac{3}{x^2}y^4$ and $w = y^{-3}$ we obtain $\frac{dw}{dx} + \frac{6}{x}w = -\frac{9}{x^2}$. An integrating factor is x^6 so that $x^6w = -\frac{9}{5}x^5 + c$ or $y^{-3} = -\frac{9}{5}x^{-1} + cx^{-6}$. If $y(1) = \frac{1}{2}$ then $c = \frac{49}{5}$ and $y^{-3} = -\frac{9}{5}x^{-1} + \frac{49}{5}x^{-6}$.
22. From $y' + y = y^{-1/2}$ and $w = y^{3/2}$ we obtain $\frac{dw}{dx} + \frac{3}{2}w = \frac{3}{2}$. An integrating factor is $e^{3x/2}$ so that $e^{3x/2}w = e^{3x/2} + c$ or $y^{3/2} = 1 + ce^{-3x/2}$. If $y(0) = 4$ then $c = 7$ and $y^{3/2} = 1 + 7e^{-3x/2}$.
23. Let $u = x + y + 1$ so that $du/dx = 1 + dy/dx$. Then $\frac{du}{dx} - 1 = u^2$ or $\frac{1}{1+u^2} du = dx$. Thus $\tan^{-1} u = x + c$ or $u = \tan(x + c)$, and $x + y + 1 = \tan(x + c)$ or $y = \tan(x + c) - x - 1$.
24. Let $u = x + y$ so that $du/dx = 1 + dy/dx$. Then $\frac{du}{dx} - 1 = \frac{1-u}{u}$ or $u du = dx$. Thus $\frac{1}{2}u^2 = x + c$ or $u^2 = 2x + c_1$, and $(x + y)^2 = 2x + c_1$.
25. Let $u = x + y$ so that $du/dx = 1 + dy/dx$. Then $\frac{du}{dx} - 1 = \tan^2 u$ or $\cos^2 u du = dx$. Thus $\frac{1}{2}u + \frac{1}{4}\sin 2u = x + c$ or $2u + \sin 2u = 4x + c_1$, and $2(x + y) + \sin 2(x + y) = 4x + c_1$ or $2y + \sin 2(x + y) = 2x + c_1$.
26. Let $u = x + y$ so that $du/dx = 1 + dy/dx$. Then $\frac{du}{dx} - 1 = \sin u$ or $\frac{1}{1 + \sin u} du = dx$. Multiplying by $(1 - \sin u)/(1 - \sin u)$ we have $\frac{1 - \sin u}{\cos^2 u} du = dx$ or $(\sec^2 u - \sec u \tan u) du = dx$. Thus $\tan u - \sec u = x + c$ or $\tan(x + y) - \sec(x + y) = x + c$.
27. Let $u = y - 2x + 3$ so that $du/dx = dy/dx - 2$. Then $\frac{du}{dx} + 2 = 2 + \sqrt{u}$ or $\frac{1}{\sqrt{u}} du = dx$. Thus $2\sqrt{u} = x + c$ and $2\sqrt{y - 2x + 3} = x + c$.
28. Let $u = y - x + 5$ so that $du/dx = dy/dx - 1$. Then $\frac{du}{dx} + 1 = 1 + e^u$ or $e^{-u} du = dx$. Thus $-e^{-u} = x + c$ and $-e^{-y+x-5} = x + c$.
29. Let $u = x + y$ so that $du/dx = 1 + dy/dx$. Then $\frac{du}{dx} - 1 = \cos u$ and $\frac{1}{1 + \cos u} du = dx$. Now

$$\frac{1}{1 + \cos u} = \frac{1 - \cos u}{1 - \cos^2 u} = \frac{1 - \cos u}{\sin^2 u} = \csc^2 u - \csc u \cot u$$

so we have $\int (\csc^2 u - \csc u \cot u) du = \int dx$ and $-\cot u + \csc u = x + c$. Thus $-\cot(x + y) + \csc(x + y) = x + c$. Setting $x = 0$ and $y = \pi/4$ we obtain $c = \sqrt{2} - 1$. The solution is

$$\csc(x + y) - \cot(x + y) = x + \sqrt{2} - 1.$$

30. Let $u = 3x + 2y$ so that $du/dx = 3 + 2dy/dx$. Then $\frac{du}{dx} = 3 + \frac{2u}{u+2} = \frac{5u+6}{u+2}$ and $\frac{u+2}{5u+6} du = dx$. Now by long division

$$\frac{u+2}{5u+6} = \frac{1}{5} + \frac{4}{25u+30}$$

so we have

$$\int \left(\frac{1}{5} + \frac{4}{25u+30} \right) du = dx$$

and $\frac{1}{5}u + \frac{4}{25} \ln |25u+30| = x + c$. Thus

$$\frac{1}{5}(3x+2y) + \frac{4}{25} \ln |75x+50y+30| = x + c.$$

Setting $x = -1$ and $y = -1$ we obtain $c = \frac{4}{25} \ln 95$. The solution is

$$\frac{1}{5}(3x+2y) + \frac{4}{25} \ln |75x+50y+30| = x + \frac{4}{25} \ln 95$$

or

$$5y - 5x + 2 \ln |75x + 50y + 30| = 2 \ln 95$$

31. We write the differential equation $M(x, y)dx + N(x, y)dy = 0$ as $dy/dx = f(x, y)$ where

$$f(x, y) = -\frac{M(x, y)}{N(x, y)}.$$

The function $f(x, y)$ must necessarily be homogeneous of degree 0 when M and N are homogeneous of degree α . Since M is homogeneous of degree α , $M(tx, ty) = t^\alpha M(x, y)$, and letting $t = 1/x$ we have

$$M(1, y/x) = \frac{1}{x^\alpha} M(x, y) \quad \text{or} \quad M(x, y) = x^\alpha M(1, y/x).$$

Thus

$$\frac{dy}{dx} = f(x, y) = -\frac{x^\alpha M(1, y/x)}{x^\alpha N(1, y/x)} = -\frac{M(1, y/x)}{N(1, y/x)} = F\left(\frac{y}{x}\right).$$

32. Rewrite $(5x^2 - 2y^2)dx - xy dy = 0$ as

$$xy \frac{dy}{dx} = 5x^2 - 2y^2$$

and divide by xy , so that

$$\frac{dy}{dx} = 5 \frac{x}{y} - 2 \frac{y}{x}.$$

We then identify

$$F\left(\frac{y}{x}\right) = 5 \left(\frac{y}{x}\right)^{-1} - 2 \left(\frac{y}{x}\right).$$

33. (a) By inspection $y = x$ and $y = -x$ are solutions of the differential equation and not members of the family $y = x \sin(\ln x + c_2)$.

(b) Letting $x = 5$ and $y = 0$ in $\sin^{-1}(y/x) = \ln x + c_2$ we get $\sin^{-1} 0 = \ln 5 + c_2$ or $c_2 = -\ln 5$. Then $\sin^{-1}(y/x) = \ln x - \ln 5 = \ln(x/5)$. Because the range of the arcsine function is $[-\pi/2, \pi/2]$ we must have

$$\begin{aligned} -\frac{\pi}{2} &\leq \ln \frac{x}{5} \leq \frac{\pi}{2} \\ e^{-\pi/2} &\leq \frac{x}{5} \leq e^{\pi/2} \\ 5e^{-\pi/2} &\leq x \leq 5e^{\pi/2} \end{aligned}$$

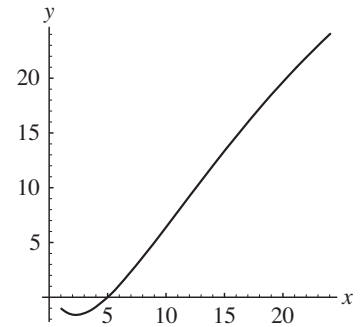

The interval of definition of the solution is approximately $[1.04, 24.05]$.

34. As $x \rightarrow -\infty$, $e^{6x} \rightarrow 0$ and $y \rightarrow 2x + 3$. Now write $(1 + ce^{6x})/(1 - ce^{6x})$ as $(e^{-6x} + c)/(e^{-6x} - c)$. Then, as $x \rightarrow \infty$, $e^{-6x} \rightarrow 0$ and $y \rightarrow 2x - 3$.

35. (a) The substitutions $y = y_1 + u$ and

$$\frac{dy}{dx} = \frac{dy_1}{dx} + \frac{du}{dx}$$

lead to

$$\begin{aligned} \frac{dy_1}{dx} + \frac{du}{dx} &= P + Q(y_1 + u) + R(y_1 + u)^2 \\ &= P + Qy_1 + Ry_1^2 + Qu + 2y_1Ru + Ru^2 \end{aligned}$$

or

$$\frac{du}{dx} - (Q + 2y_1R)u = Ru^2.$$

This is a Bernoulli equation with $n = 2$ which can be reduced to the linear equation

$$\frac{dw}{dx} + (Q + 2y_1R)w = -R$$

by the substitution $w = u^{-1}$.

(b) Identify $P(x) = -4/x^2$, $Q(x) = -1/x$, and $R(x) = 1$. Then $\frac{dw}{dx} + \left(-\frac{1}{x} + \frac{4}{x}\right)w = -1$.

An integrating factor is x^3 so that $x^3w = -\frac{1}{4}x^4 + c$ or $u = \left[-\frac{1}{4}x + cx^{-3}\right]^{-1}$. Thus,

$$y = \frac{2}{x} + u \quad \text{or} \quad y = \frac{2}{x} + \left(-\frac{1}{4}x + cx^{-3}\right)^{-1}$$

36. Write the differential equation in the form $x(y'/y) = \ln x + \ln y$ and let $u = \ln y$. Then $du/dx = y'/y$ and the differential equation becomes $x(du/dx) = \ln x + u$ or $du/dx - u/x =$

$(\ln x)/x$, which is first-order and linear. An integrating factor is $e^{-\int dx/x} = 1/x$, so that (using integration by parts)

$$\frac{d}{dx} \left[\frac{1}{x} u \right] = \frac{\ln x}{x^2} \quad \text{and} \quad \frac{u}{x} = -\frac{1}{x} - \frac{\ln x}{x} + c.$$

The solution is

$$\ln y = -1 - \ln x + cx \quad \text{or} \quad y = \frac{e^{cx-1}}{x}.$$

37. Write the differential equation as

$$\frac{dv}{dx} + \frac{1}{x} v = 32v^{-1},$$

and let $u = v^2$ or $v = u^{1/2}$. Then

$$\frac{dv}{dx} = \frac{1}{2} u^{-1/2} \frac{du}{dx},$$

and substituting into the differential equation, we have

$$\frac{1}{2} u^{-1/2} \frac{du}{dx} + \frac{1}{x} u^{1/2} = 32u^{-1/2} \quad \text{or} \quad \frac{du}{dx} + \frac{2}{x} u = 64.$$

The latter differential equation is linear with integrating factor $e^{\int (2/x) dx} = x^2$, so

$$\frac{d}{dx} [x^2 u] = 64x^2$$

and

$$x^2 u = \frac{64}{3} x^3 + c \quad \text{or} \quad v^2 = \frac{64}{3} x + \frac{c}{x^2}.$$

38. Write the differential equation as $dP/dt - aP = -bP^2$ and let $u = P^{-1}$ or $P = u^{-1}$. Then

$$\frac{dp}{dt} = -u^{-2} \frac{du}{dt},$$

and substituting into the differential equation, we have

$$-u^{-2} \frac{du}{dt} - au^{-1} = -bu^{-2} \quad \text{or} \quad \frac{du}{dt} + au = b.$$

The latter differential equation is linear with integrating factor $e^{\int a dt} = e^{at}$, so

$$\frac{d}{dt} [e^{at} u] = be^{at}$$

and

$$e^{at} u = \frac{b}{a} e^{at} + c$$

$$e^{at} P^{-1} = \frac{b}{a} e^{at} + c$$

$$P^{-1} = \frac{b}{a} + ce^{-at}$$

$$P = \frac{1}{b/a + ce^{-at}} = \frac{a}{b + c_1 e^{-at}}.$$

2.6 A Numerical Method

1. We identify $f(x, y) = 2x - 3y + 1$. Then, for $h = 0.1$,

$$y_{n+1} = y_n + 0.1(2x_n - 3y_n + 1) = 0.2x_n + 0.7y_n + 0.1,$$

and

$$y(1.1) \approx y_1 = 0.2(1) + 0.7(5) + 0.1 = 3.8$$

$$y(1.2) \approx y_2 = 0.2(1.1) + 0.7(3.8) + 0.1 = 2.98$$

For $h = 0.05$,

$$y_{n+1} = y_n + 0.05(2x_n - 3y_n + 1) = 0.1x_n + 0.85y_n + 0.1,$$

and

$$y(1.05) \approx y_1 = 0.1(1) + 0.85(5) + 0.1 = 4.4$$

$$y(1.1) \approx y_2 = 0.1(1.05) + 0.85(4.4) + 0.1 = 3.895$$

$$y(1.15) \approx y_3 = 0.1(1.1) + 0.85(3.895) + 0.1 = 3.47075$$

$$y(1.2) \approx y_4 = 0.1(1.15) + 0.85(3.47075) + 0.1 = 3.11514$$

2. We identify $f(x, y) = x + y^2$. Then, for $h = 0.1$,

$$y_{n+1} = y_n + 0.1(x_n + y_n^2) = 0.1x_n + y_n + 0.1y_n^2,$$

and

$$y(0.1) \approx y_1 = 0.1(0) + 0 + 0.1(0)^2 = 0$$

$$y(0.2) \approx y_2 = 0.1(0.1) + 0 + 0.1(0)^2 = 0.01$$

For $h = 0.05$,

$$y_{n+1} = y_n + 0.05(x_n + y_n^2) = 0.05x_n + y_n + 0.05y_n^2,$$

and

$$y(0.05) \approx y_1 = 0.05(0) + 0 + 0.05(0)^2 = 0$$

$$y(0.1) \approx y_2 = 0.05(0.05) + 0 + 0.05(0)^2 = 0.0025$$

$$y(0.15) \approx y_3 = 0.05(0.1) + 0.0025 + 0.05(0.0025)^2 = 0.0075$$

$$y(0.2) \approx y_4 = 0.05(0.15) + 0.0075 + 0.05(0.0075)^2 = 0.0150$$

3. Separating variables and integrating, we have

$$\frac{dy}{y} = dx \quad \text{and} \quad \ln|y| = x + c.$$

Thus $y = c_1 e^x$ and, using $y(0) = 1$, we find $c = 1$, so $y = e^x$ is the solution of the initial-value problem.

$h = 0.1$

x_n	y_n	Actual Value	Abs. Error	%Rel. Error
0.00	1.0000	1.0000	0.0000	0.00
1.10	1.1000	1.1052	0.0052	0.47
0.20	1.2100	1.2214	0.0114	0.93
0.30	1.3310	1.3499	0.0189	1.40
0.40	1.4641	1.4918	0.0277	1.86
0.50	1.6105	1.6487	0.0382	2.32
0.60	1.7716	1.8221	0.0506	2.77
0.70	1.9487	2.0138	0.0650	3.23
0.80	2.1436	2.2255	0.0820	3.68
0.90	2.3579	2.4596	0.1017	4.13
1.00	2.5937	2.7183	0.1245	4.58

 $h = 0.05$

x_n	y_n	Actual Value	Abs. Error	%Rel. Error
0.00	1.0000	1.0000	0.0000	0.00
0.05	1.0500	1.0513	0.0013	0.12
0.10	1.1025	1.1052	0.0027	0.24
0.15	1.1576	1.1618	0.0042	0.36
0.20	1.2155	1.2214	0.0059	0.48
0.25	1.2763	1.2840	0.0077	0.60
0.30	1.3401	1.3499	0.0098	0.72
0.35	1.4071	1.4191	0.0120	0.84
0.40	1.4775	1.4918	0.0144	0.96
0.45	1.5513	1.5683	0.0170	1.08
0.50	1.6289	1.6487	0.0198	1.20
0.55	1.7103	1.7333	0.0229	1.32
0.60	1.7959	1.8221	0.0263	1.44
0.65	1.8856	1.9155	0.0299	1.56
0.70	1.9799	2.0138	0.0338	1.68
0.75	2.0789	2.1170	0.0381	1.80
0.80	2.1829	2.2255	0.0427	1.92
0.85	2.2920	2.3396	0.0476	2.04
0.90	2.4066	2.4596	0.0530	2.15
0.95	2.5270	2.5857	0.0588	2.27
1.00	2.6533	2.7183	0.0650	2.39

4. Separating variables and integrating, we have

$$\frac{dy}{y} = 2x dx \quad \text{and} \quad \ln|y| = x^2 + c.$$

Thus $y = c_1 e^{x^2}$ and, using $y(1) = 1$, we find $c = e^{-1}$, so $y = e^{x^2-1}$ is the solution of the initial-value problem.

 $h = 0.1$

x_n	y_n	Actual Value	Abs. Error	%Rel. Error
1.00	1.0000	1.0000	0.0000	0.00
1.10	1.2000	1.2337	0.0337	2.73
1.20	1.4640	1.5527	0.0887	5.71
1.30	1.8154	1.9937	0.1784	8.95
1.40	2.2874	2.6117	0.3243	12.42
1.50	2.9278	3.4903	0.5625	16.12

 $h = 0.05$

x_n	y_n	Actual Value	Abs. Error	%Rel. Error
1.00	1.0000	1.0000	0.0000	0.00
1.05	1.1000	1.1079	0.0079	0.72
1.10	1.2155	1.2337	0.0182	1.47
1.15	1.3492	1.3806	0.0314	2.27
1.20	1.5044	1.5527	0.0483	3.11
1.25	1.6849	1.7551	0.0702	4.00
1.30	1.8955	1.9937	0.0982	4.93
1.35	2.1419	2.2762	0.1343	5.90
1.40	2.4311	2.6117	0.1806	6.92
1.45	2.7714	3.0117	0.2403	7.98
1.50	3.1733	3.4903	0.3171	9.08

5. $h = 0.1$

x_n	y_n
0.00	0.0000
0.10	0.1000
0.20	0.1905
0.30	0.2731
0.40	0.3492
0.50	0.4198

 $h = 0.05$

x_n	y_n
0.00	0.0000
0.05	0.0500
0.10	0.0976
0.15	0.1429
0.20	0.1863
0.25	0.2278
0.30	0.2676
0.35	0.3058
0.40	0.3427
0.45	0.3782
0.50	0.4124

6. $h = 0.1$

x_n	y_n
0.00	1.0000
0.10	1.1000
0.20	1.2220
0.30	1.3753
0.40	1.5735
0.50	1.8371

 $h = 0.05$

x_n	y_n
0.00	1.0000
0.05	1.0500
0.10	1.1053
0.15	1.1668
0.20	1.2360
0.25	1.3144
0.30	1.4039
0.35	1.5070
0.40	1.6267
0.45	1.7670
0.50	1.9332

7. $h = 0.1$

x_n	y_n
0.00	0.5000
0.10	0.5250
0.20	0.5431
0.30	0.5548
0.40	0.5613
0.50	0.5639

 $h = 0.05$

x_n	y_n
0.00	0.5000
0.05	0.5125
0.10	0.5232
0.15	0.5322
0.20	0.5395
0.25	0.5452
0.30	0.5496
0.35	0.5527
0.40	0.5547
0.45	0.5559
0.50	0.5565

8. $h = 0.1$

x_n	y_n
0.00	1.0000
0.10	1.1000
0.20	1.2159
0.30	1.3505
0.40	1.5072
0.50	1.6902

 $h = 0.05$

x_n	y_n
0.00	1.0000
0.05	1.0500
0.10	1.1039
0.15	1.1619
0.20	1.2245
0.25	1.2921
0.30	1.3651
0.35	1.4440
0.40	1.5293
0.45	1.6217
0.50	1.7219

9. $h = 0.1$

x_n	y_n
1.00	1.0000
1.10	1.0000
1.20	1.0191
1.30	1.0588
1.40	1.1231
1.50	1.2194

 $h = 0.05$

x_n	y_n
1.00	1.0000
1.05	1.0000
1.10	1.0049
1.15	1.0147
1.20	1.0298
1.25	1.0506
1.30	1.0775
1.35	1.1115
1.40	1.1538
1.45	1.2057
1.50	1.2696

10. $h = 0.1$

x_n	y_n
0.00	0.5000
0.10	0.5250
0.20	0.5499
0.30	0.5747
0.40	0.5991
0.50	0.6231

 $h = 0.05$

x_n	y_n
0.00	0.5000
0.05	0.5125
0.10	0.5250
0.15	0.5375
0.20	0.5499
0.25	0.5623
0.30	0.5746
0.35	0.5868
0.40	0.5989
0.45	0.6109
0.50	0.6228

11. Tables of values were computed using the Euler and RK4 methods. The resulting points were plotted and joined using **ListPlot** in *Mathematica*.

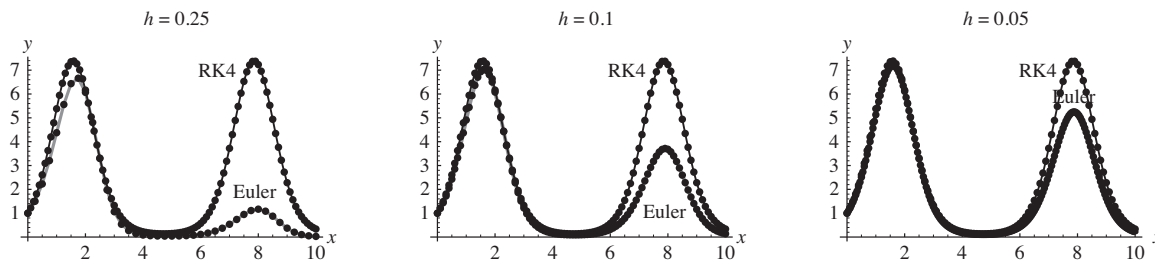

12. See the comments in Problem 11 above.

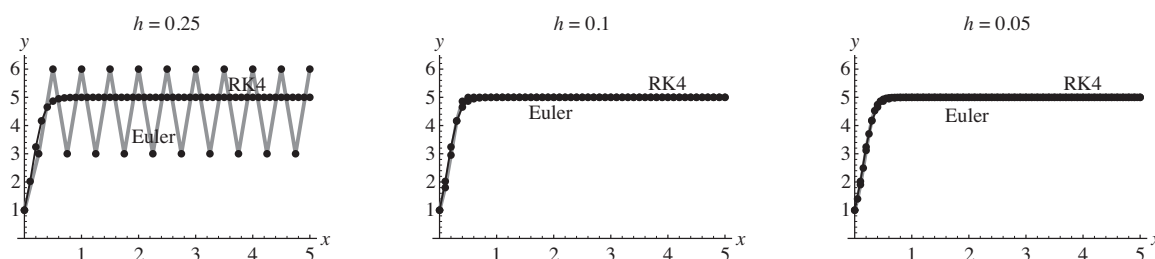

13. Using separation of variables we find that the solution of the differential equation is $y = 1/(1 - x^2)$, which is undefined at $x = 1$, where the graph has a vertical asymptote. Because the actual solution of the differential equation becomes unbounded as x approaches 1, very small changes in the inputs x will result in large changes in the corresponding outputs y . This can be expected to have a serious effect on numerical procedures. The graphs below were obtained as described in Problem 11.

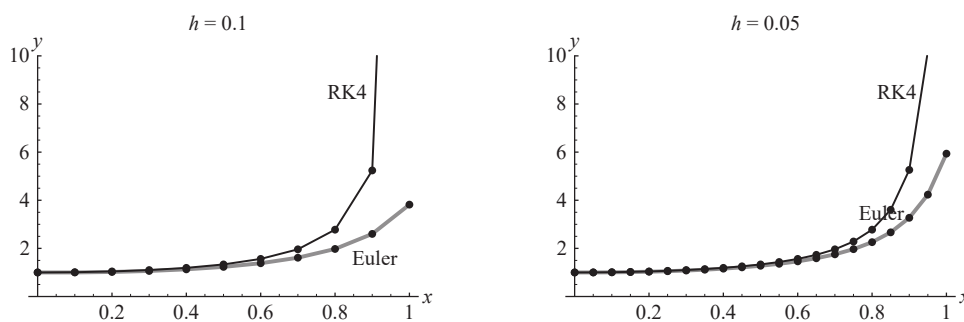

14. (a) The graph to the right was obtained using RK4 and **ListPlot** in *Mathematica* with $h = 0.1$.

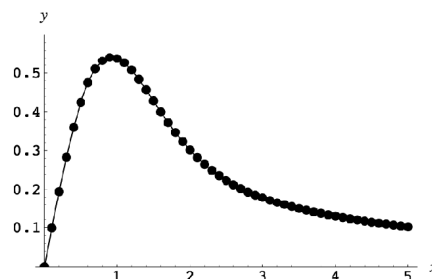

- (b) Writing the differential equation in the form $y' + 2xy = 1$ we see that an integrating factor is $e^{\int 2x dx} = e^{x^2}$, so

$$\frac{d}{dx}[e^{x^2}y] = e^{x^2}$$

and

$$y = e^{-x^2} \int_0^x e^{t^2} dt + ce^{-x^2}.$$

This solution can also be expressed in terms of the inverse error function as

$$y = \frac{\sqrt{\pi}}{2} e^{-x^2} \operatorname{erfi}(x) + ce^{-x^2}.$$

Letting $x = 0$ and $y(0) = 0$ we find $c = 0$, so the solution of the initial-value problem is

$$y = e^{-x^2} \int_0^x e^{t^2} dt = \frac{\sqrt{\pi}}{2} e^{-x^2} \operatorname{erfi}(x).$$

- (c) Using **FindRoot** in *Mathematica* we see that $y'(x) = 0$ when $x = 0.924139$. Since $y(0.924139) = 0.541044$, we see from the graph in part (a) that $(0.924139, 0.541044)$ is a relative maximum. Now, using the substitution $u = -t$ in the integral below, we have

$$y(-x) = e^{-(-x)^2} \int_0^{-x} e^{t^2} dt = e^{-x^2} \int_0^x e^{(-u)^2} (-du) = -e^{-x^2} \int_0^x e^{u^2} du = -y(x).$$

Thus, $y(x)$ is an odd function and $(-0.924139, -0.541044)$ is a relative minimum.

Chapter 2 in Review

1. Writing the differential equation in the form $y' = k(y + A/k)$ we see that the critical point $-A/k$ is a repeller for $k > 0$ and an attractor for $k < 0$.
2. Separating variables and integrating we have

$$\frac{dy}{y} = \frac{4}{x} dx$$

$$\ln y = 4 \ln x + c = \ln x^4 + c$$

$$y = c_1 x^4.$$

We see that when $x = 0$, $y = 0$, so the initial-value problem has an infinite number of solutions for $k = 0$ and no solutions for $k \neq 0$.

3. True; $y = k_2/k_1$ is always a solution for $k_1 \neq 0$.
4. True; writing the differential equation as $a_1(x) dy + a_2(x)y dx = 0$ and separating variables yields

$$\frac{dy}{y} = -\frac{a_2(x)}{a_1(x)} dx.$$

5. $\frac{d^3y}{dx^3} = x \sin y$ (There are many answers.)

6. False: $\frac{dr}{d\theta} = r\theta + r + \theta + 1 = (r+1)(\theta+1)$.

7. True

8. Since the differential equation in the form $y' = 2 - |y|$ is seen to be autonomous, $2 - |y| = 0$ has critical points 2 and -2 so $y_1 = 2$ and $y_2 = -2$ are constant (equilibrium) solutions.

9. $\frac{dy}{y} = e^x dx$

$$\ln y = e^x + c$$

$$y = e^{e^x+c} = e^c e^{e^x} \quad \text{or} \quad y = c_1 e^{e^x}$$

10. $y' = |x|, \quad y(-1) = 2$

$$\frac{dy}{dx} = \begin{cases} -x, & x < 0 \\ x, & x \geq 0 \end{cases}$$

$$y = \begin{cases} -\frac{1}{2}x^2 + c_1, & x < 0 \\ \frac{1}{2}x^2 + c_2, & x \geq 0 \end{cases}$$

The initial condition $y(-1) = 2$ implies $2 = -\frac{1}{2} + c_1$ and thus $c_1 = \frac{5}{2}$. Now $y(x)$ is supposed to be differentiable and so continuous. At $x = 0$ the two parts of the functions must agree and so $c_2 = c_1 = \frac{5}{2}$. So,

$$y = \begin{cases} \frac{1}{2}(5 - x^2), & x < 0 \\ \frac{1}{2}(x^2 + 5), & x \geq 0 \end{cases}$$

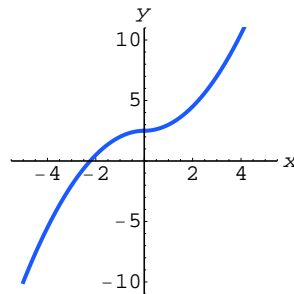

11. $y = e^{\cos x} \int_0^x t e^{-\cos t} dt$

$$\frac{dy}{dx} = e^{\cos x} x e^{-\cos x} + (-\sin x) e^{\cos x} \int_0^x t e^{-\cos t} dt$$

$$\frac{dy}{dx} = x - (\sin x) y \quad \text{or} \quad \frac{dy}{dx} + (\sin x) y = x.$$

12. $\frac{dy}{dx} = y + 3, \quad \frac{dy}{dx} = (y + 3)^2$

13. $\frac{dy}{dx} = (y - 1)^2(y - 3)^2$

14. $\frac{dy}{dx} = y(y - 2)^2(y - 4)$

15. When n is odd, $x^n < 0$ for $x < 0$ and $x^n > 0$ for $x > 0$. In this case 0 is unstable. When n is even, $x^n > 0$ for $x < 0$ and for $x > 0$. In this case 0 is semi-stable.

When n is odd, $-x^n > 0$ for $x < 0$ and $-x^n < 0$ for $x > 0$. In this case 0 is asymptotically stable. When n is even, $-x^n < 0$ for $x < 0$ and for $x > 0$. In this case 0 is semi-stable.

16. Using a CAS we find that the zero of f occurs at approximately $P = 1.3214$. From the graph we observe that $dP/dt > 0$ for $P < 1.3214$ and $dP/dt < 0$ for $P > 1.3214$, so $P = 1.3214$ is an asymptotically stable critical point. Thus, $\lim_{t \rightarrow \infty} P(t) = 1.3214$.

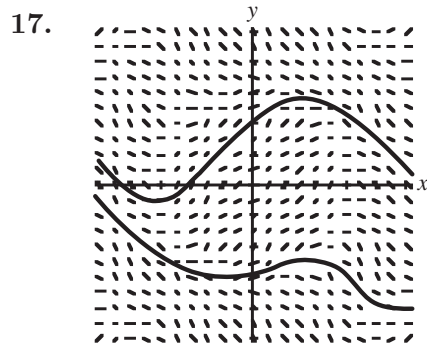

18.

- | | |
|---|--|
| (a) linear in y , homogeneous, exact | (b) linear in x |
| (c) separable, exact, linear in x and y | (d) Bernoulli in x |
| (e) separable | (f) separable, linear in x , Bernoulli |
| (g) linear in x | (h) homogeneous |
| (i) Bernoulli | (j) homogeneous, exact, Bernoulli |
| (k) linear in x and y , exact, separable, homogeneous | (l) exact, linear in y |
| (m) homogeneous | (n) separable |

19. Separating variables and using the identity $\cos^2 x = \frac{1}{2}(1 + \cos 2x)$, we have

$$\cos^2 x \, dx = \frac{y}{y^2 + 1} \, dy,$$

$$\frac{1}{2}x + \frac{1}{4} \sin 2x = \frac{1}{2} \ln(y^2 + 1) + c,$$

and

$$2x + \sin 2x = 2 \ln(y^2 + 1) + c.$$

20. Write the differential equation in the form

$$y \ln \frac{x}{y} dx = \left(x \ln \frac{x}{y} - y \right) dy.$$

This is a homogeneous equation, so let $x = uy$. Then $dx = u dy + y du$ and the differential equation becomes

$$y \ln u (u dy + y du) = (uy \ln u - y) dy \quad \text{or} \quad y \ln u du = -dy.$$

Separating variables, we obtain

$$\ln u du = -\frac{dy}{y}$$

$$u \ln |u| - u = -\ln |y| + c$$

$$\frac{x}{y} \ln \left| \frac{x}{y} \right| - \frac{x}{y} = -\ln |y| + c$$

$$x(\ln x - \ln y) - x = -y \ln |y| + cy.$$

21. The differential equation

$$\frac{dy}{dx} + \frac{2}{6x+1}y = -\frac{3x^2}{6x+1}y^{-2}$$

is Bernoulli. Using $w = y^3$, we obtain the linear equation

$$\frac{dw}{dx} + \frac{6}{6x+1}w = -\frac{9x^2}{6x+1}.$$

An integrating factor is $6x + 1$, so

$$\frac{d}{dx} [(6x+1)w] = -9x^2,$$

$$w = -\frac{3x^3}{6x+1} + \frac{c}{6x+1},$$

and

$$(6x+1)y^3 = -3x^3 + c.$$

(Note: The differential equation is also exact.)

22. Write the differential equation in the form $(3y^2 + 2x)dx + (4y^2 + 6xy)dy = 0$. Letting $M = 3y^2 + 2x$ and $N = 4y^2 + 6xy$ we see that $M_y = 6y = N_x$, so the differential equation is exact. From $f_x = 3y^2 + 2x$ we obtain $f = 3xy^2 + x^2 + h(y)$. Then $f_y = 6xy + h'(y) = 4y^2 + 6xy$ and $h'(y) = 4y^2$ so $h(y) = \frac{4}{3}y^3$. A one-parameter family of solutions is

$$3xy^2 + x^2 + \frac{4}{3}y^3 = c.$$

23. Write the equation in the form

$$\frac{dQ}{dt} + \frac{1}{t}Q = t^3 \ln t.$$

An integrating factor is $e^{\ln t} = t$, so

$$\frac{d}{dt} [tQ] = t^4 \ln t$$

$$tQ = -\frac{1}{25}t^5 + \frac{1}{5}t^5 \ln t + c$$

and

$$Q = -\frac{1}{25}t^4 + \frac{1}{5}t^4 \ln t + \frac{c}{t}.$$

24. Letting $u = 2x + y + 1$ we have

$$\frac{du}{dx} = 2 + \frac{dy}{dx},$$

and so the given differential equation is transformed into

$$u \left(\frac{du}{dx} - 2 \right) = 1 \quad \text{or} \quad \frac{du}{dx} = \frac{2u + 1}{u}.$$

Separating variables and integrating we get

$$\frac{u}{2u + 1} du = dx$$

$$\left(\frac{1}{2} - \frac{1}{2} \frac{1}{2u + 1} \right) du = dx$$

$$\frac{1}{2}u - \frac{1}{4} \ln |2u + 1| = x + c$$

$$2u - \ln |2u + 1| = 4x + c_1.$$

Resubstituting for u gives the solution

$$4x + 2y + 2 - \ln |4x + 2y + 3| = 4x + c_1$$

or

$$2y + 2 - \ln |4x + 2y + 3| = c_1.$$

25. Write the equation in the form

$$\frac{dy}{dx} + \frac{8x}{x^2 + 4}y = \frac{2x}{x^2 + 4}.$$

An integrating factor is $(x^2 + 4)^4$, so

$$\frac{d}{dx} \left[(x^2 + 4)^4 y \right] = 2x (x^2 + 4)^3$$

$$(x^2 + 4)^4 y = \frac{1}{4} (x^2 + 4)^4 + c$$

and

$$y = \frac{1}{4} + c(x^2 + 4)^{-4}.$$

- 26.** Letting $M = 2r^2 \cos \theta \sin \theta + r \cos \theta$ and $N = 4r + \sin \theta - 2r \cos^2 \theta$ we see that $M_r = 4r \cos \theta \sin \theta + \cos \theta = N_\theta$, so the differential equation is exact. From $f_\theta = 2r^2 \cos \theta \sin \theta + r \cos \theta$ we obtain $f = -r^2 \cos^2 \theta + r \sin \theta + h(r)$. Then $f_r = -2r \cos^2 \theta + \sin \theta + h'(r) = 4r + \sin \theta - 2r \cos^2 \theta$ and $h'(r) = 4r$ so $h(r) = 2r^2$. The solution is

$$-r^2 \cos^2 \theta + r \sin \theta + 2r^2 = c.$$

- 27.** We put the equation $\frac{dy}{dx} + 4(\cos x)y = x$ in the standard form $\frac{dy}{dx} + 2(\cos x)y = \frac{1}{2}x$ then the integrating factor is $e^{\int 2 \cos x dx} = e^{2 \sin x}$. Therefore

$$\begin{aligned} \frac{d}{dx} [e^{2 \sin x} y] &= \frac{1}{2} x e^{2 \sin x} \\ \int_0^x \frac{d}{dt} [e^{2 \sin t} y(t)] dt &= \frac{1}{2} \int_0^x t e^{2 \sin t} dt \\ e^{2 \sin x} y(x) - e^0 \overbrace{y(0)}^1 &= \frac{1}{2} \int_0^x t e^{2 \sin t} dt \\ e^{2 \sin x} y(x) - 1 &= \frac{1}{2} \int_0^x t e^{2 \sin t} dy \\ y(x) &= e^{-2 \sin x} + \frac{1}{2} e^{-2 \sin x} \int_0^x t e^{2 \sin t} dt \end{aligned}$$

- 28.** The equation $\frac{dy}{dx} - 4xy = \sin x^2$ is already in standard form so the integrating factor is $e^{-\int 4x dx} = e^{-2x^2}$. Therefore $\frac{d}{dx} [e^{-2x^2} y] = e^{-2x^2} \sin x^2$. Because of the initial condition $y(0) = 7$ we write

$$\begin{aligned} \int_0^x \frac{d}{dt} [e^{-2t^2} y(t)] dt &= \int_0^x e^{-2t^2} \sin t^2 dt \\ e^{-2x^2} y(x) - e^0 \overbrace{y(0)}^7 &= \int_0^x e^{-2t^2} \sin t^2 dt \\ y(x) &= 7e^{2x^2} + e^{2x^2} \int_0^x e^{-2t^2} \sin t^2 dt \end{aligned}$$

29. We put the equation $x \frac{dy}{dx} + 2y = xe^{x^2}$ into standard form $\frac{dy}{dx} + \frac{2}{x}y = e^{x^2}$. Then the integrating factor is $e^{\int \frac{2}{x} dx} = e^{\ln x^2} = x^2$. Therefore

$$\begin{aligned} x^2 \frac{dy}{dx} + 2xy &= x^2 e^{x^2} \\ \frac{d}{dx} [x^2 y] &= x^2 e^{x^2} \\ \int_1^x \frac{d}{dt} [t^2 y(t)] dt &= \int_1^x t^2 e^{t^2} dt \\ x^2 y(x) - \overbrace{y(1)}^3 &= \int_1^x t^2 e^{t^2} dt \\ y(x) &= \frac{3}{x^2} + \frac{1}{x^2} \int_1^x t^2 e^{t^2} dt \end{aligned}$$

30.

$$\begin{aligned} x \frac{dy}{dx} + (\sin x) y &= 0 \\ \frac{dy}{dx} + \frac{\sin x}{x} y &= 0 \end{aligned}$$

The integrating factor is $e^{\int_0^x \frac{\sin t}{t} dt}$. Therefore,

$$\begin{aligned} \frac{d}{dx} [e^{\int_0^x \frac{\sin t}{t} dt} y] &= 0 \\ \int_0^x \frac{d}{dt} [e^{\int_0^t \frac{\sin u}{u} du} y(t)] dt &= \int_0^x 0 dt = 0 \\ e^{\int_0^x \frac{\sin t}{t} dt} y(x) - e^0 \overbrace{y(0)}^{10} &= 0 \\ y(x) &= 10e^{-\int_0^x \frac{\sin t}{t} dt} \end{aligned}$$

31.

$$\frac{dy}{dx} + y = f(x), \quad y(0) = 5, \quad \text{where } f(x) = \begin{cases} e^{-x}, & 0 \leq x < 1 \\ 0, & x \geq 1 \end{cases}$$

For $0 \leq x < 1$,

$$\begin{aligned} \frac{d}{dx} [e^x y] &= 1 \\ e^x y &= x + c_1 \\ y &= xe^{-x} + c_1 e^{-x} \end{aligned}$$

Using $y(0) = 5$, we have $c_1 = 5$. Therefore $y = xe^{-x} + 5e^{-x}$. Then for $x \geq 1$,

$$\begin{aligned}\frac{d}{dx}[e^x y] &= 0 \\ e^x y &= c_2 \\ y &= c_2 e^{-x}\end{aligned}$$

Requiring that $y(x)$ be continuous at $x = 1$ yields

$$\begin{aligned}c_2 e^{-1} &= e^{-1} + 5e^{-1} \\ c_2 &= 6\end{aligned}$$

Therefore

$$y(x) = \begin{cases} xe^{-x} + 5e^{-x}, & 0 \leq x < 1 \\ 6e^{-x}, & x \geq 1 \end{cases}$$

32.

$$\frac{dy}{dx} + P(x)y = e^x, \quad y(0) = -1, \quad \text{where } P(x) = \begin{cases} 1, & 0 \leq x < 1 \\ -1, & x \geq 1 \end{cases}$$

For $0 \leq x < 1$,

$$\begin{aligned}\frac{d}{dx}[e^x y] &= e^{2x} \\ e^x y &= \frac{1}{2}e^{2x} + c_1 \\ y &= \frac{1}{2}e^x + c_1 e^{-x}\end{aligned}$$

Using $y(0) = -1$, we have $c_1 = -\frac{3}{2}$. Therefore $y = \frac{1}{2}e^x - \frac{3}{2}e^{-x}$. Then for $x \geq 1$,

$$\begin{aligned}\frac{d}{dx}[e^{-x} y] &= 1 \\ e^{-x} y &= x + c_2 \\ y &= xe^x + c_2 e^x\end{aligned}$$

Requiring that $y(x)$ be continuous at $x = 1$ yields

$$\begin{aligned}e + c_2 e &= \frac{1}{2}e - \frac{3}{2}e^{-1} \\ c_2 &= -\frac{1}{2} - \frac{3}{2}e^{-2}\end{aligned}$$

Therefore

$$y(x) = \begin{cases} \frac{1}{2}e^x - \frac{3}{2}e^{-x}, & 0 \leq x < 1 \\ xe^x - \frac{1}{2}e^x - \frac{3}{2}e^{x-2}, & x \geq 1 \end{cases}$$

33. The differential equation has the form $(d/dx)[(\sin x)y] = 0$. Integrating, we have $(\sin x)y = c$ or $y = c/\sin x$. The initial condition implies $c = -2\sin(7\pi/6) = 1$. Thus, $y = 1/\sin x$, where the interval $(\pi, 2\pi)$ is chosen to include $x = 7\pi/6$.

34. Separating variables and integrating we have

$$\begin{aligned}\frac{dy}{y^2} &= -2(t+1) dt \\ -\frac{1}{y} &= -(t+1)^2 + c \\ y &= \frac{1}{(t+1)^2 + c_1}, \quad \text{where } -c = c_1\end{aligned}$$

The initial condition $y(0) = -\frac{1}{8}$ implies $c_1 = -9$, so a solution of the initial-value problem is

$$y = \frac{1}{(t+1)^2 - 9} \quad \text{or} \quad y = \frac{1}{t^2 + 2t - 8},$$

where $-4 < t < 2$.

35. (a) For $y < 0$, \sqrt{y} is not a real number.

(b) Separating variables and integrating we have

$$\frac{dy}{\sqrt{y}} = dx \quad \text{and} \quad 2\sqrt{y} = x + c.$$

Letting $y(x_0) = y_0$ we get $c = 2\sqrt{y_0} - x_0$, so that

$$2\sqrt{y} = x + 2\sqrt{y_0} - x_0 \quad \text{and} \quad y = \frac{1}{4}(x + 2\sqrt{y_0} - x_0)^2.$$

Since $\sqrt{y} > 0$ for $y \neq 0$, we see that $dy/dx = \frac{1}{2}(x + 2\sqrt{y_0} - x_0)$ must be positive. Thus, the interval on which the solution is defined is $(x_0 - 2\sqrt{y_0}, \infty)$.

36. (a) The differential equation is homogeneous and we let $y = ux$. Then

$$\begin{aligned}(x^2 - y^2) dx + xy dy &= 0 \\ (x^2 - u^2x^2) dx + ux^2(u dx + x du) &= 0 \\ dx + ux du &= 0\end{aligned}$$

$$u du = -\frac{dx}{x}$$

$$\frac{1}{2}u^2 = -\ln|x| + c$$

$$\frac{y^2}{x^2} = -2\ln|x| + c_1.$$

The initial condition gives $c_1 = 2$, so an implicit solution is $y^2 = x^2(2 - 2\ln|x|)$.

- (b) Solving for y in part (a) and being sure that the initial condition is still satisfied, we have $y = -\sqrt{2}|x|(1 - \ln|x|)^{1/2}$, where $-e \leq x \leq e$ so that $1 - \ln|x| \geq 0$. The graph of this function indicates that the derivative is not defined at $x = 0$ and $x = e$. Thus, the solution of the initial-value problem is $y = -\sqrt{2}x(1 - \ln x)^{1/2}$, for $0 < x < e$.

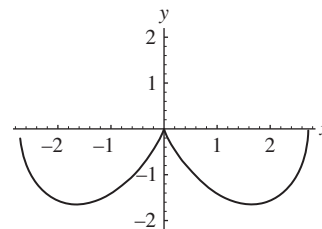

37. The graph of $y_1(x)$ is the portion of the closed blue curve lying in the fourth quadrant. Its interval of definition is approximately $(0.7, 4.3)$. The graph of $y_2(x)$ is the portion of the left-hand blue curve lying in the third quadrant. Its interval of definition is $(-\infty, 0)$.
38. The first step of Euler's method gives $y(1.1) \approx 9 + 0.1(1 + 3) = 9.4$. Applying Euler's method one more time gives $y(1.2) \approx 9.4 + 0.1(1 + 1.1\sqrt{9.4}) \approx 9.8373$.

39. Since the differential equation is autonomous, all lineal elements on a given horizontal line have the same slope. The direction field is then as shown in the figure at the right. It appears from the figure that the differential equation has critical points at -2 (an attractor) and at 2 (a repeller). Thus, -2 is an asymptotically stable critical point and 2 is an unstable critical point.

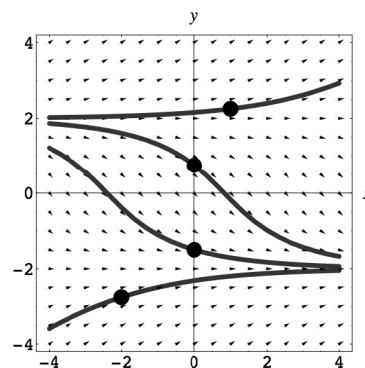

40. Since the differential equation is autonomous, all lineal elements on a given horizontal line have the same slope. The direction field is then as shown in the figure at the right. It appears from the figure that the differential equation has no critical points.

