

# **Instructor's Solutions Manual**

# **Circuit Analysis**

*A Systems Approach*

**Russell M. Mersereau  
Joel R. Jackson**

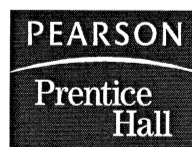

Upper Saddle River, New Jersey 07458

Assistant Editor: *Alice Dworkin*  
Editorial Assistant: *Richard Virginia*  
Executive Managing Editor: *Vince O'Brien*  
Managing Editor: *David A. George*  
Production Editor: *Daniel Sandin*  
Manufacturing Buyer: *Lisa McDowell*



© 2006 by Pearson Education, Inc.  
Pearson Prentice Hall  
Pearson Education, Inc.  
Upper Saddle River, NJ 07458

All rights reserved. No part of this book may be reproduced in any form or by any means, without permission in writing from the publisher.

The author and publisher of this book have used their best efforts in preparing this book. These efforts include the development, research, and testing of the theories and programs to determine their effectiveness. The author and publisher make no warranty of any kind, expressed or implied, with regard to these programs or the documentation contained in this book. The author and publisher shall not be liable in any event for incidental or consequential damages in connection with, or arising out of, the furnishing, performance, or use of these programs.

Pearson Prentice Hall™ is a trademark of Pearson Education, Inc.

This work is protected by United States copyright laws and is provided solely for the use of instructors in teaching their courses and assessing student learning. Dissemination or sale of any part of this work (including on the World Wide Web) will destroy the integrity of the work and is not permitted. The work and materials from it should never be made available to students except by instructors using the accompanying text in their classes. All recipients of this work are expected to abide by these restrictions and to honor the intended pedagogical purposes and the needs of other instructors who rely on these materials.

Printed in the United States of America

10 9 8 7 6 5 4 3 2 1

ISBN 0-13-047580-7

Pearson Education Ltd., *London*  
Pearson Education Australia Pty. Ltd., *Sydney*  
Pearson Education Singapore, Pte. Ltd.  
Pearson Education North Asia Ltd., *Hong Kong*  
Pearson Education Canada, Inc., *Toronto*  
Pearson Educación de México, S.A. de C.V.  
Pearson Education—Japan, *Tokyo*  
Pearson Education Malaysia, Pte. Ltd.  
Pearson Education, Inc., *Upper Saddle River, New Jersey*

# Contents

Chapter 1	1
Chapter 2	67
Chapter 3	145
Chapter 4	205
Chapter 5	251
Chapter 6	277
Chapter 7	333
Chapter 8	393
Chapter 9	443
Chapter 10	499
Appendix A	537



# Chapter 1

## Circuit Elements and Models

The numbers in parentheses after the problem numbers refer to the abilities needed to work the problem. These are listed in the final section of the chapter labelled "New Abilities Required."

### Drill Problems

All drill problems have solutions on the CD-ROM.

**P-1.1 (4)** For the circuit in Figure 1.1 write a KCL equation at every node in the circuit in terms of the current variables whose reference directions are given. This problem is similar to Example 1-1.

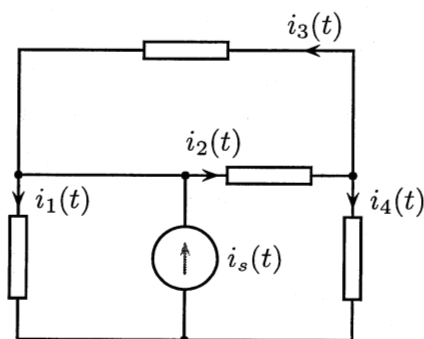
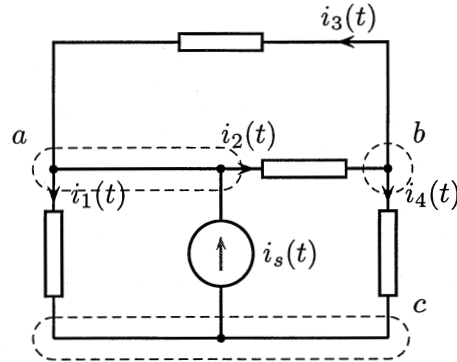

Figure 1.1: Circuit for Problems P-1.1 and P-1.7.

---

**Solution:** There are three nodes in this circuit as shown below.



If we sum the currents *entering* the node, then the three KCL equations are:

$$\text{node } a: \quad -i_1(t) - i_2(t) + i_3(t) + i_s(t) = 0$$

$$\text{node } b: \quad i_2(t) - i_3(t) - i_4(t) = 0$$

$$\text{node } c: \quad i_1(t) + i_4(t) - i_s(t) = 0.$$

**P-1.2 (4)** Write a sufficient set of KCL equations for the circuit in Figure 1.2. This problem is similar to Example 1-1.

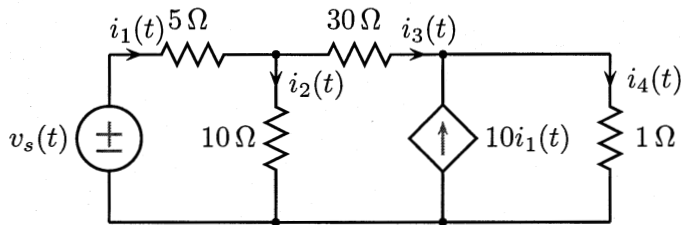
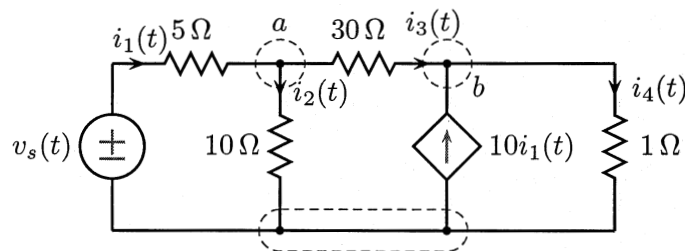

Figure 1.2: Circuit for Problems P-1.2 and P-1.28.

**Solution:** The circuit contains the three non-trivial nodes indicated below.



$$\text{node } a: \quad i_1(t) - i_2(t) - i_3(t) = 0$$

$$\text{node } b: \quad i_3(t) + 10i_1(t) - i_4(t) = 0$$

**P-1.3 (1,4)** The circuit in Figure 1.3 contains four elements and a voltage source. Write a sufficient set of KCL equations to fully constrain all the currents in the circuit. You may exploit any obvious series and parallel connections to reduce the number of variables. Notice that only the voltages are labelled, although you should write your equations using current variables. You should assume that the reference directions for the currents are consistent with the default sign convention. Furthermore, let the current flowing into the element with voltage  $v_1(t)$  be  $i_1(t)$ , etc. This problem is similar to Example 1-2.

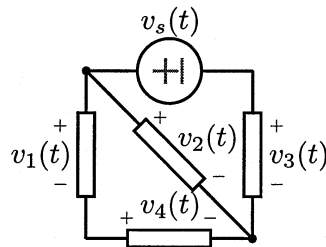

Figure 1.3: Circuit for Problems P-1.3 and P-1.5.

**Solution:** Element 1 is connected in series with element 4. Therefore,  $i_1(t) = i_4(t)$ . Element 3 is connected in series with the voltage source. Therefore, the current that flows through the voltage source is  $i_3(t)$ . Once these facts are acknowledged, we are left with only two nodes—one at the upper left and one at the lower right—that produce the same KCL equation:

$$i_1(t) + i_2(t) + i_3(t) = 0.$$

**P-1.4 (1,2,4,7)** For the circuit in Figure 1.4 write a sufficient set of KCL equations in terms of the voltage variables that are labelled. You should incorporate Ohm's Law for the resistors. Exploit any obvious series and parallel connections to reduce the number of equations and variables. This problem is similar to Example 1-3.

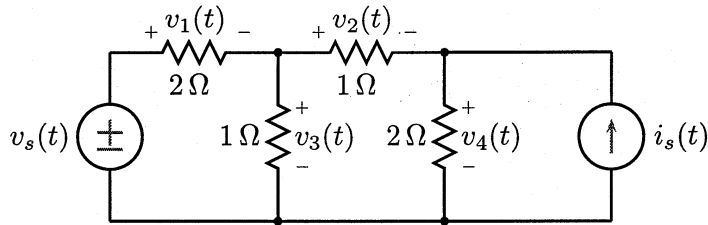
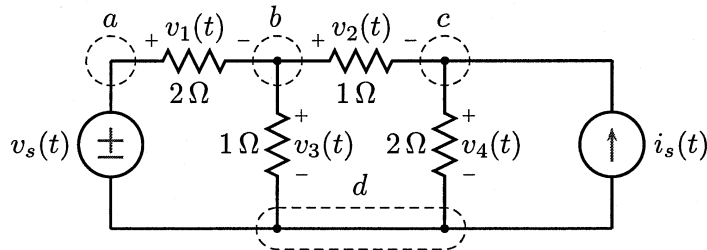

Figure 1.4: Circuit for Problems P-1.4 and P-1.26.

**Solution:** We begin by redrawing the circuit to identify the four nodes.



Since the circuit contains four nodes, it will be sufficient to write only three KCL equations. The equation at node  $a$ , will tell us only that the current flowing upwards through the voltage source is the same as  $i_s(t)$ , since these two “elements” are connected in series; we can ignore this one. That leave only nodes  $b$  and  $c$ .

$$\text{node } b: \quad \frac{v_1(t)}{2} - v_2(t) - v_3(t) = 0$$

$$\text{node } c: \quad v_2(t) - \frac{v_4(t)}{2} = -i_s(t)$$

**P-1.5 (5)** Write a KVL equation for every simple closed path in the circuit in Figure 1.3 in terms of the voltages whose reference directions are given in that figure. This problem is similar to Example 1-4.

**Solution:** There are three simple closed paths: a path around the left mesh, a path around the right mesh, and an outer path.

$$\text{left:} \quad -v_1(t) + v_2(t) - v_4(t) = 0$$

$$\text{right:} \quad v_3(t) - v_2(t) + v_s(t) = 0$$

$$\text{outer:} \quad -v_1(t) + v_s(t) + v_3(t) - v_4(t) = 0$$



Notice that the third equation is equal to the sum of the first two.

---

**P-1.6 (5)** Write a sufficient set of KVL equations to incorporate the constraints on the voltages over all closed paths for the circuit in Figure 1.5. This problem is similar to Example 1-4.

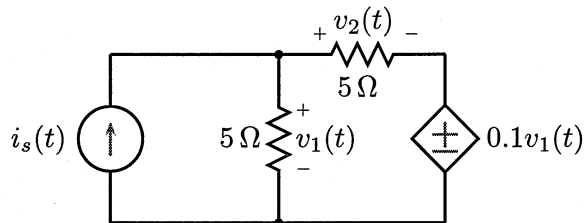

Figure 1.5: Circuit for Problems P-1.6 and P-1.29.

---

**Solution:** Let the potential difference across the current source be  $v(t)$ , as drawn. There are two meshes in this circuit, so it is sufficient to write two KVL equations, one for each mesh.

$$\text{left mesh: } -v(t) + v_1(t) = 0$$

$$\text{right mesh: } -v_1(t) + v_2(t) + 0.1v_1(t) = 0 \implies -0.9v_1(t) + v_2(t) = 0$$

---

**P-1.7 (5)** Write a sufficient set of KVL equations to incorporate all of the voltage constraints for the circuit in Figure 1.1. Since only the currents are labelled, you should assume that the reference directions for the element voltages are consistent with the default sign convention. Let the voltage across the element with current  $i_1(t)$  be  $v_1(t)$ , etc. Define a voltage across the terminals of the current source. This problem is similar to Example 1-5.

---

**Solution:** We need to write a KVL equation for each mesh. Let  $v(t)$  be the voltage across the current source.

$$\text{upper: } -v_3(t) - v_2(t) = 0$$

$$\text{lower left: } -i_1(t) + v(t) = 0$$

$$\text{lower right: } -v(t) + v_2(t) + v_4(t) = 0$$

---

**P-1.8 (1,2,5,7)** For the circuit in Figure 1.6 write a sufficient set of KVL equations to constrain all of the element variables in terms of the current variables that are indicated. You should incorporate Ohm's Law for the resistors. Use any obvious series and parallel connections to reduce the number of equations and variables. This problem is similar to Example 1-7.

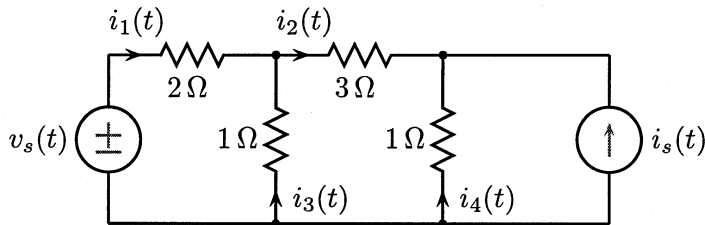

Figure 1.6: Circuit for Problems P-1.8 and P-1.27.

---

**Solution:** The right mesh KVL equation tells us only that the voltage across the current source is the same as the voltage across the resistor connected in parallel to it. The remaining two KVL equations are:

$$\begin{aligned} \text{left mesh: } & 2i_1(t) - i_3(t) = v_s(t) \\ \text{center mesh: } & i_3(t) + 3i_2(t) - i_4(t) = 0 \end{aligned}$$

---

**P-1.9 (2,4,5)**

This problem is similar to Example 1-7.

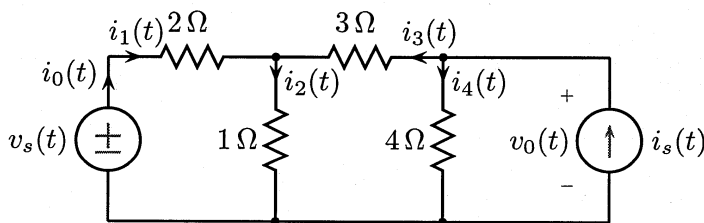

Figure 1.7: Circuit for Problem P-1.9.

- How many nodes are present in the circuit in Figure 1.7?
- How many meshes are present in that circuit?
- Write a KCL equation at *every* node in the circuit in terms of the indicated current and voltage variables.

- (d) Write a KVL equation for every mesh in the circuit. Write those equations using the indicated current variables by incorporating Ohm's Law for each resistor.

---

**Solution:**

- (a) The circuit has four nodes, three on the top row of the circuit and one at the bottom.
- (b) The circuit has three meshes.
- (c) Let node  $a$  be the connection between the positive terminal of the voltage source and the  $2\ \Omega$  resistor, node  $b$  be the connection where the three resistors are joined, node  $c$  be the connection joining the  $3\ \Omega$  resistor,  $4\ \Omega$  resistor, and the current source, and node  $d$  be the one at the base of the circuit. Then, the four KCL equations are:

$$\text{node } a: \quad i_0(t) - i_1(t) = 0$$

$$\text{node } b: \quad i_1(t) - i_2(t) + i_3(t) = 0$$

$$\text{node } c: \quad -i_3(t) - i_4(t) + i_s(t) = 0$$

$$\text{node } d: \quad -i_0(t) + i_2(t) + i_4(t) - i_s(t) = 0.$$

- (d) Denote the three meshes as the left, middle, and right mesh, respectively. Then the three KVL equations are:

$$\text{left mesh:} \quad -v_s(t) + 2i_1(t) + i_2(t) = 0$$

$$\text{middle mesh:} \quad -i_2(t) - 3i_3(t) + 4i_4(t) = 0$$

$$\text{right mesh:} \quad -4i_4(t) + v_0(t) = 0.$$

---

**P-1.10 (2,4,5)**

All resistances are measured in Ohms. This problem is similar to Example 1-7.

- (a) How many meshes are present in the circuit in Figure 1.8?
- (b) How many nodes are present in that circuit?
- (c) Write a KVL equation at every mesh in the circuit in terms of the indicated voltage and current variables.
- (d) Write a KCL equation for *every* node in the circuit. Write those equations using the indicated voltage variables by incorporating Ohm's Law for each resistor.

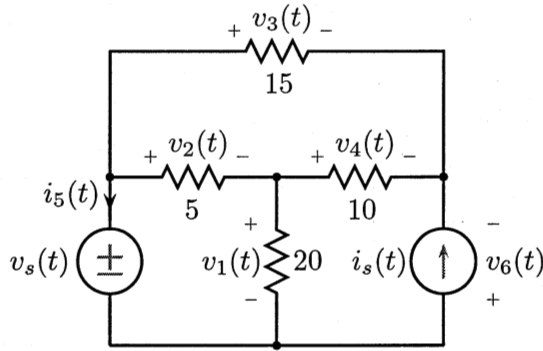

Figure 1.8: Circuit for Problem P-1.10.

**Solution:**

- (a) This circuit has three meshes. Call them the top mesh, left mesh, and right mesh.
- (b) This circuit has four nodes. In this circuit each is marked by one of the solid dots. Beginning at the upper left node and proceeding clockwise, call these nodes  $a$ ,  $b$ ,  $c$ , and  $d$ .
- (c) The KVL equations are:

$$\begin{aligned} \text{top mesh:} \quad & -v_2(t) + v_3(t) - v_4(t) = 0 \\ \text{left mesh:} \quad & v_1(t) + v_2(t) - v_s(t) = 0 \\ \text{right mesh:} \quad & -v_1(t) + v_4(t) - v_6(t) = 0. \end{aligned}$$

- (d) The KCL equations at all of the nodes are:

$$\begin{aligned} \text{node } a: \quad & \frac{v_2(t)}{5} + \frac{v_3(t)}{15} + i_5(t) = 0 \\ \text{node } b: \quad & \frac{v_1(t)}{20} - \frac{v_2(t)}{5} + \frac{v_4(t)}{10} = 0 \\ \text{node } c: \quad & -\frac{v_3(t)}{15} - \frac{v_4(t)}{10} - i_s(t) = 0 \\ \text{node } d: \quad & -\frac{v_1(t)}{20} - i_5(t) + i_s(t) = 0. \end{aligned}$$

**P-1.11 (6)** This problem is similar to Example 1-7.

- (a) For the network in Figure 1.9 write a set of equations that expresses all of the constraints on the element and source voltages and currents that are implied by the network model.
- (b) Solve those equations to determine  $i_2(t)$ .

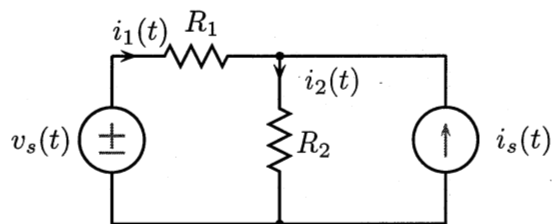

Figure 1.9: Circuit for Problem P-1.11.

---

**Solution:**

- (a) Since  $R_1$  is in series with the voltage source, the current  $i_1(t)$  passes through that source as well as  $R_1$ . In addition, we can let  $v_2(t)$  be the voltage across both resistor  $R_2$  and the current source, since those elements are connected in parallel.

We are left with four unknowns—the two resistor voltages and the two resistor currents. To find the complete solution we will, therefore, need to find four independent equations. Thus, we should write two element relations for the two resistors, one KCL equation, and one KVL equation. These are written below.

$$R_1 : v_1(t) = R_1 i_1(t)$$

$$R_2 : v_2(t) = R_2 i_2(t)$$

$$\text{KCL: } i_1(t) - i_2(t) + i_s(t) = 0$$

$$\text{KVL: } -v_s(t) + v_1(t) + v_2(t) = 0$$

- (b) Use the element relations to eliminate  $v_1(t)$  and  $v_2(t)$  in the KVL equation, and rewrite the remaining equations with the source terms on the right-hand side. This gives the following two equations for the two unknown currents:

$$i_1(t) - i_2(t) = -i_s(t)$$

$$R_1 i_1(t) + R_2 i_2(t) = v_s(t).$$

If we multiply the first equation by  $R_1$  and subtract the two equations, we can solve for  $i_2(t)$ :

$$i_2(t) = \frac{1}{R_1 + R_2} [v_s(t) + R_1 i_s(t)].$$

---

**P-1.12 (2,4,5)** Find the differential equation that relates the current  $i_R(t)$  to the source current  $i_s(t)$  in the circuit of Figure 1.56. This problem is similar to Example 1-10.

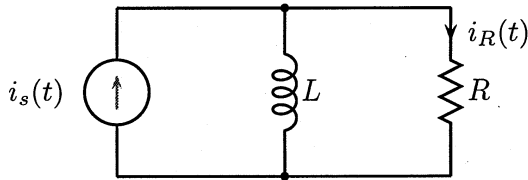

Figure 1.10: Circuit for Problem P-1.12.

**Solution:** Let the (top-to-bottom) current through the inductor be  $i_\ell(t)$ . Then from KCL

$$i_\ell(t) + i_R(t) = i_s(t).$$

Writing a KVL equation around the right mesh gives

$$-L \frac{di_\ell(t)}{dt} + Ri_R(t) = 0$$

Using the KCL equation to solve for  $i_\ell(t)$  and substituting this result into the KVL equation gives

$$-L \frac{d}{dt}(i_s(t) - i_R(t)) + Ri_R(t) = 0,$$

which simplifies to

$$\frac{di_R(t)}{dt} + \frac{R}{L}i_R(t) = \frac{di_s(t)}{dt}.$$

**P-1.13 (6)** The circuit in Figure 1.11 contains a voltage-controlled current source.

Write a sufficient set of KCL equations to specify the current constraints in the circuit using the variables  $i_1(t)$ ,  $i_2(t)$ , and  $i_3(t)$ .

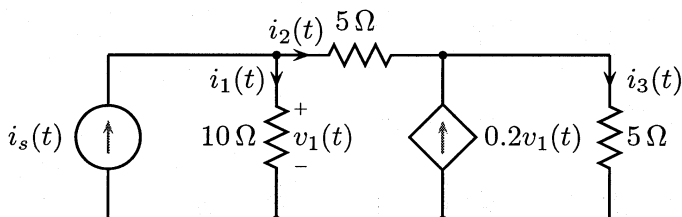

Figure 1.11: Circuit for Problems P-1.13 and P-1.14.

---

**Solution:** First we need to express  $v_1(t)$  in terms of the current variables.

$$v_1(t) = 10i_1(t) \implies 0.2v_1(t) = 2i_1(t)$$

Writing KCL equations at the two upper nodes gives

$$\begin{aligned} i_1(t) + i_2(t) &= i_s(t) \\ i_2(t) + 2i_1(t) - i_3(t) &= 0 \end{aligned}$$

---

**P-1.14 (6)** Find the values of the currents for the circuit in Figure 1.11. This problem is similar to Example 1-11.

---

**Solution:** This solution builds on the solution to Problem P-1.13. Let the potential difference across the terminals of the dependent source be  $v(t)$ . We can then redraw the circuit as shown in Figure 1.12. Notice that we have changed the voltage-controlled current source to a current-controlled current source. From the solution to Problem P-1.13 the KCL equations at the two upper nodes are

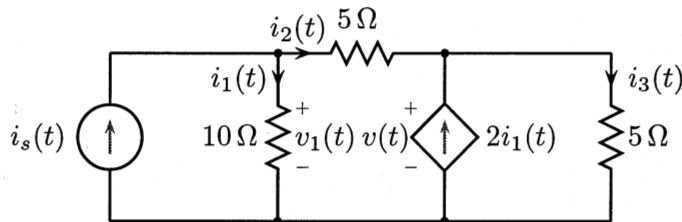

Figure 1.12: Redrawn version of Figure 1.11 to indicate the dependence of the source on  $i_1(t)$  rather than  $v_1(t)$ . The voltage  $v(t)$  is also defined.

From the solution to Problem P-1.13 the KCL equations at the two upper nodes are

$$i_1(t) + i_2(t) = i_s(t) \quad (1.1)$$

$$i_2(t) + 2i_1(t) - i_3(t) = 0. \quad (1.2)$$

Writing two KVL equations on the two rightmost meshes, using the labelled currents as variables, gives the additional relations

$$-10i_1(t) + 5i_2(t) + v(t) = 0$$

$$-v(t) + 5i_3(t) = 0.$$

Adding these last two equations eliminates  $v(t)$  and yields

$$-10i_1(t) + 5i_2(t) + 5i_3(t) = 0 \quad (1.3)$$

Multiplying (1.2) by 5 and adding the result to (1.3) gives

$$10i_2(t) = 0 \implies \boxed{i_2(t) = 0.}$$

Incorporating this result into (1.1) gives

$$\boxed{i_1(t) = i_s(t)}$$

and from (1.2)

$$\boxed{i_3(t) = 2i_s(t).}$$

## Basic Problems

**P-1.15 (2,3)** Assume that the current flowing through a device is  $i(t)$  and that the potential difference across its terminals is  $v(t)$ , where these waveforms are sketched in Figure 1.13. Mathematically these are given by

$$v(t) = \begin{cases} 1, & 0 < t < 1 \\ 0, & \text{otherwise} \end{cases}$$

$$i(t) = \begin{cases} 1 - e^{-3t}, & 0 \leq t < 1 \\ e^{-3(t-1)}, & 1 \leq t \\ 0, & \text{otherwise} \end{cases}$$

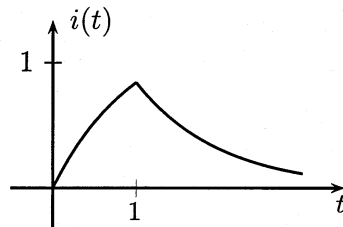
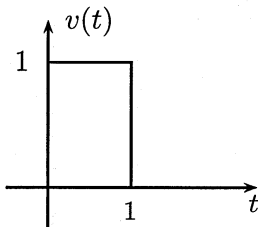

Figure 1.13: Voltage and current waveforms for Problem P-1.15.

- Calculate and sketch the power  $P_{inst}(t)$  absorbed by the device as a function of time.
- Compute the total amount of energy that the device absorbs.

**Solution:**



(a)

$$P_{inst}(t) = v(t)i(t) = \begin{cases} 1 - e^{-3t}, & 0 \leq t < 1 \\ 0, & \text{otherwise.} \end{cases}$$

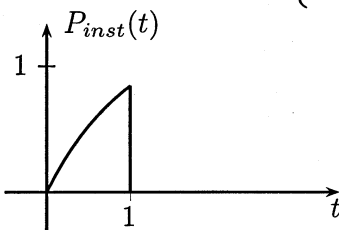

(b) The total energy absorbed is

$$E = \int_0^1 P_{inst}(t) dt = \frac{2}{3} + \frac{1}{3}e^{-3}$$

**P-1.16 (2,7)** The current source in the network shown in Figure 1.14a has the time dependence shown in Figure 1.14b.

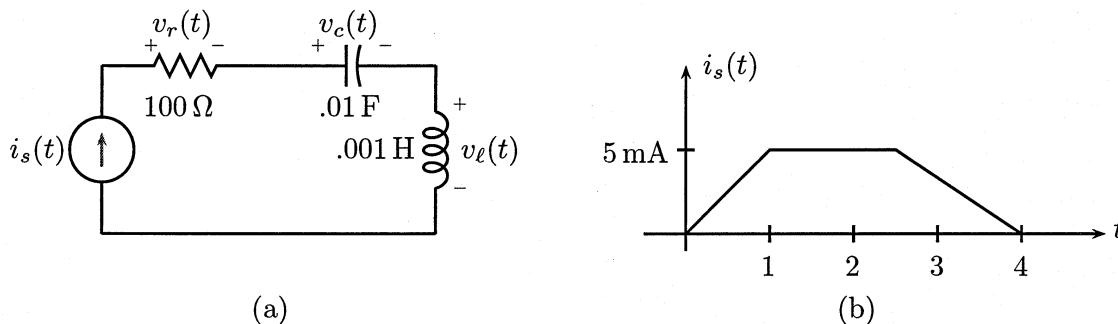

Figure 1.14: Circuit and source waveform for Problem P-1.16.

- (a) Sketch  $v_r(t)$ .
- (b) Sketch  $v_l(t)$ .
- (c) Assuming  $v_c(0) = 0$ , sketch  $v_c(t)$ .

**Solution:**

- (a) The same current  $i_s(t)$  passes through all three elements: the resistor, the capacitor, and the inductor. For each, we make use of its element relation. For the resistor

$$v_r(t) = 100i_r(t).$$

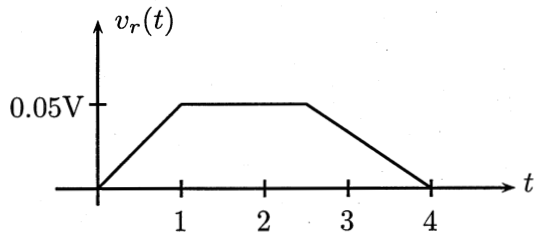

Figure 1.15: Resistor voltage derived from the current waveform shown in Figure 1.13.

Since the voltage is proportional to the current and the current is known, we can readily graph the voltage waveform, which is done in Figure 1.15

- (b) For the inductor the voltage is proportional to the first derivative of the current passing through it, which is  $i_s(t)$ . Thus,

$$v_\ell(t) = 0.001 \frac{di_s(t)}{dt}.$$

This waveform is plotted in Figure 1.16.

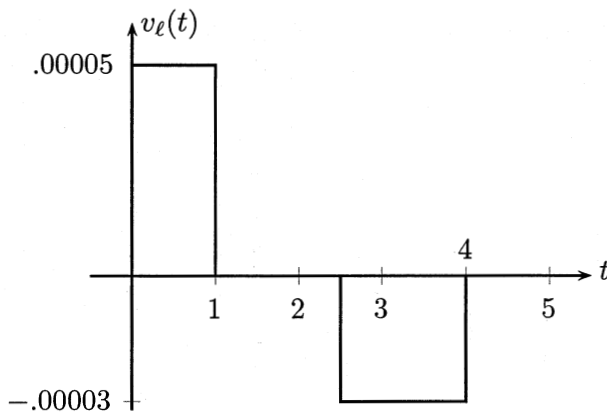

Figure 1.16: Inductor voltage derived from the current waveform shown in Figure 1.13.

- (c) For the capacitor the voltage is proportional to the integral of the current:

$$v_c(t) = \frac{1}{C} \int_{t_0}^t i_s(\beta) d\beta + v_c(t_0).$$

If we assume that the voltage on the capacitor is zero at  $t = 0$ , then

$$v_c(t) = 100 \int_0^t i_s(\beta) d\beta,$$

for  $t > 0$ , which is graphed in Figure 1.17. The graph was produced with the help of MATLAB.

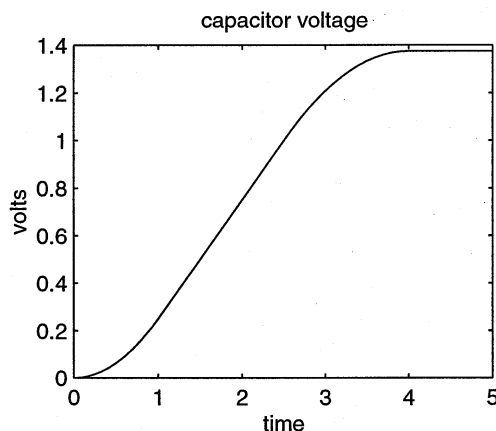

Figure 1.17: Capacitor voltage derived from the current waveform shown in Figure 1.13.

**P-1.17 (2,7)** The voltage source in the circuit shown in Figure 1.18a has the source waveform shown in Figure 1.18b.

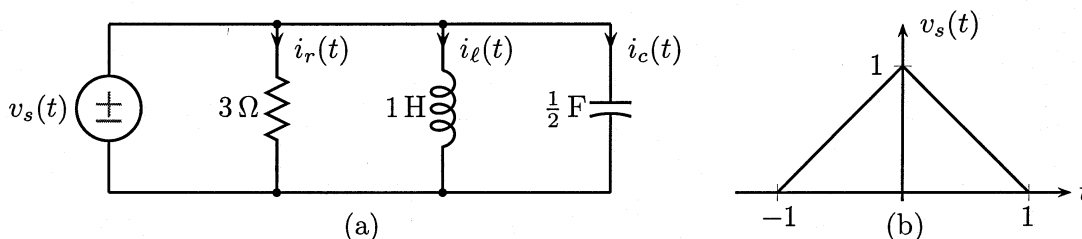

Figure 1.18: Circuit and source waveform for Problem P-1.17.

- Sketch  $i_r(t)$ .
- Sketch  $i_c(t)$ .
- Sketch  $i_l(t)$ . Assume  $i_l(-\infty) = 0$ .

**Solution:**

- The same voltage,  $v_s(t)$  is applied to all three elements by the voltage source. This means that we can find each current by using the appropriate element relation. For the resistor,

$$i_r(t) = \frac{1}{R}v_r(t) = \frac{1}{R}v_s(t) = \frac{1}{3}v_s(t).$$

Its graph is shown below.

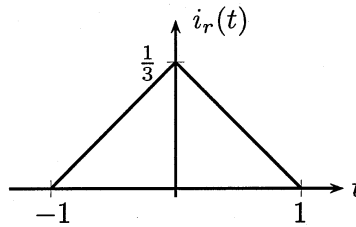

- (b) The current through a capacitor is proportional to the first derivative of the voltage. Therefore,

$$i_c(t) = C \frac{dv_c(t)}{dt} = \frac{1}{2} \frac{dv_s(t)}{dt} = \begin{cases} \frac{1}{2}, & -1 < t < 0 \\ -\frac{1}{2}, & 0 < t < 1 \\ 0, & \text{otherwise.} \end{cases}$$

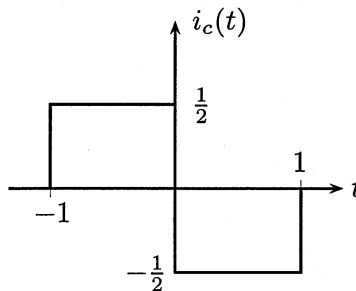

- (c) The current through an inductor is proportional to the integral of the voltage.

$$i_\ell(t) = \frac{1}{L} \int_{-\infty}^t v_\ell(\tau) d\tau + v_\ell(-\infty) = \int_{-\infty}^t v_\ell(\tau) d\tau$$

If we assume that  $i_\ell(-\infty) = 0$ , then there are four cases to consider

$$i_\ell(t) = \begin{cases} 0, & t < -1 \\ \int_{-1}^t (\tau + 1) d\tau, & -1 < t < 0 \\ \frac{1}{2} + \int_0^t (1 - \tau) d\tau, & 0 < t < 1 \\ 1, & 1 < t. \end{cases}$$

Evaluating the integrals gives

$$i_\ell(t) = \begin{cases} 0, & t < -1 \\ \frac{t^2}{2} + t + \frac{1}{2}, & -1 < t < 0 \\ -\frac{t^2}{2} + t + \frac{1}{2}, & 0 < t < 1 \\ 1, & 1 < t. \end{cases}$$

This relation is graphed below.

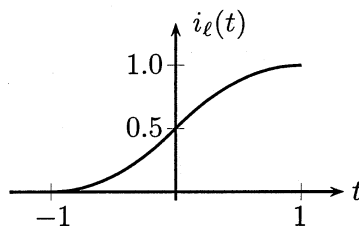

**P-1.18 (2,7)** The voltage waveform for the voltage source in the network of Figure 1.19 is

$$v_s(t) = \begin{cases} \sin 2\pi(100)t, & t \geq 0 \\ 0, & t < 0 \end{cases}$$

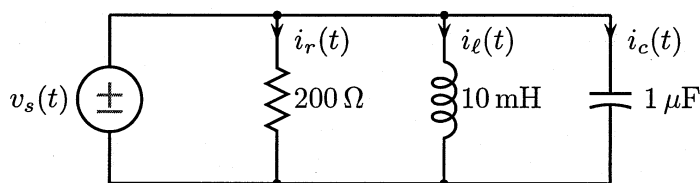

Figure 1.19: Circuit for Problem P-1.18.

- Determine  $i_r(t)$ .
- Assuming  $i_l(0) = 0$ , determine  $i_l(t)$ .
- Determine  $i_c(t)$ .

---

**Solution:**

- The potential difference across all three elements is  $v_s(t)$ . Thus, we can find their currents using a simple application of the  $v-i$  relations. For the resistor the current is proportional to the voltage

$$i_r(t) = \frac{1}{200}v_s(t) = \begin{cases} 0.005 \sin 2\pi(100)t, & t \geq 0 \\ 0, & \text{otherwise.} \end{cases}$$

- The current through an inductor is proportional to the integral of the voltage across its terminals. Therefore, we can write

$$i_l(t) = \frac{1}{.01} \int_0^t v_s(\beta) d\beta + i_l(0) = 100 \int_0^t v_s(\beta) d\beta + i_l(0).$$

Assuming that the initial value of the inductor current is zero, this gives

$$i_\ell(t) = \begin{cases} \frac{1}{2\pi} [1 - \cos 2\pi(100)t], & t \geq 0 \\ 0, & t < 0. \end{cases}$$

To determine the value of  $i_\ell(t)$  for  $t < 0$ , we appeal to the fact that the integral is equal to the area under the curve. Since  $i_\ell(t) = 0$ , for  $t < 0$ , the integral under this portion of the curve is zero also.

- (c) The current through a capacitor is proportional to the derivative of the voltage across its terminals. Therefore,

$$\begin{aligned} i_c(t) &= C \frac{dv_s(t)}{dt} = \begin{cases} 10^{-6} \cdot 2\pi(100) \cos 2\pi(100)t, & t \geq 0 \\ 0, & t < 0 \end{cases} \\ &= \begin{cases} 2\pi 10^{-4} \cos 2\pi(100)t, & t \geq 0 \\ 0, & t < 0. \end{cases} \end{aligned}$$

**P-1.19 (2,7)** In the circuit shown in Figure 1.20 the current source waveform is

$$i_s(t) = \begin{cases} 5 \cos(50t), & t > 0 \\ 0, & t < 0. \end{cases}$$

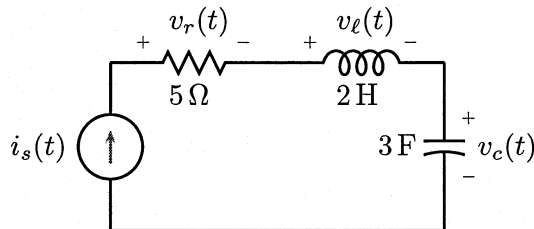

Figure 1.20: Circuit for Problem P-1.19.

- (a) Determine  $v_r(t)$ .  
 (b) Determine  $v_\ell(t)$ .  
 (c) Determine  $v_c(t)$ , if  $v_c(0) = 0$ .

**Solution:**

- (a) The same current,  $i_s(t)$ , flows through all three elements. We can calculate the voltages by using the three element relations. For the resistor

$$v_r(t) = 5i_r(t) = \begin{cases} 25 \cos(50t) & t > 0 \\ 0 & t < 0. \end{cases}$$

(b) For the inductor

$$v_\ell(t) = L \frac{dv_\ell(t)}{dt} = 2 \frac{d}{dt}(5 \cos(50t)) = -500 \sin(50t), \quad t > 0.$$

The inductor voltage  $v_\ell(t) = 0$  for  $t < 0$ .

(c) For the capacitor for  $t > 0$

$$v_c(t) = \frac{1}{C} \int_0^t i_c(\tau) d\tau = \frac{5}{3} \int_0^t \cos(50\tau) d\tau = \frac{1}{30} \sin(50t).$$

The capacitor voltage is zero for  $t < 0$ .

**P-1.20 (2,7)** For the circuit in Figure 1.21 the current source waveform is

$$i_s(t) = \begin{cases} e^{-t} - e^{-2t}, & t > 0 \\ 0, & t < 0 \end{cases}$$

It is known that  $v_c(-\infty) = 0$ .

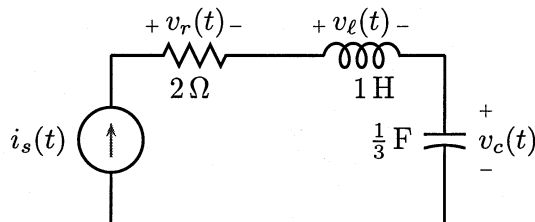

Figure 1.21: Circuit for Problem P-1.20.

- What is  $v_r(t)$ ?
- What is  $v_\ell(t)$ ?
- What is  $v_c(t)$ ?

**Solution:** The same current  $i_s(t)$  flows through all three elements.

(a)  $v_r(t) = Ri_r(t) = 2i_s(t)$ . Therefore,

$$v_r(t) = \begin{cases} 2(e^{-t} - e^{-2t}), & t > 0 \\ 0, & t < 0. \end{cases}$$

(b)  $v_\ell(t) = L \frac{di_s(t)}{dt}$ . Therefore,

$$v_\ell(t) = \begin{cases} -e^{-t} + 2e^{-2t}, & t > 0 \\ 0, & t < 0. \end{cases}$$

(c) Since

$$v_c(t) = \frac{1}{C} \int_0^t i_c(\tau) d\tau.$$

Since  $v_c(-\infty) = 0$  and  $i_c(t) = 0, t < 0$ , we must have  $v_c(0) = 0$ . This specifies the constant of integration.

$$v_c(t) = \begin{cases} -3e^{-t} + \frac{3}{2}e^{-2t} + \frac{3}{2}, & t > 0 \\ 0, & t < 0 \end{cases}$$

---

### P-1.21 (2,3)

(a) The voltage across the terminals of a 1F capacitor is

$$v(t) = \begin{cases} \frac{1}{2}(1 - \cos \pi t), & 0 < t < 2 \\ 0, & \text{otherwise.} \end{cases}$$

This waveform is shown in Figure 1.22.

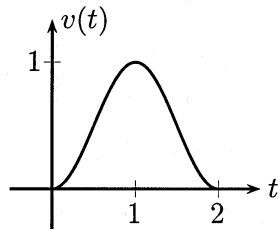

Figure 1.22: Waveform for Problem P-1.21.

- (i) Sketch the current flowing through the device,  $i(t)$ .
  - (ii) Sketch the energy stored in the device as a function of  $t$ .
  - (iii) For what values of  $t$  is the device supplying power?
  - (iv) For what values of  $t$  is the device absorbing power?
- (b) Repeat the questions asked in part (a) if  $v(t)$  is the voltage across the terminals of a 1H inductor.
- 

**Solution:**

(a) (i)

$$i_c(t) = C \frac{dv_c(t)}{dt} = \begin{cases} \frac{\pi}{2} \sin \pi t, & 0 < t < 2 \\ 0, & \text{otherwise.} \end{cases}$$

This waveform is shown on the graph in Figure 1.23.



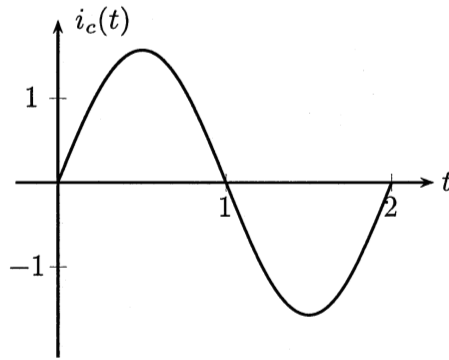

Figure 1.23: Capacitor current as a function of time.

(ii) The energy stored in a capacitor is given by

$$E_c(t) = \frac{1}{2} C v_c^2(t) = \begin{cases} \frac{1}{8}(1 - \cos \pi t)^2, & 0 < t < 2 \\ 0, & \text{otherwise.} \end{cases}$$

This is shown in Figure 1.24.

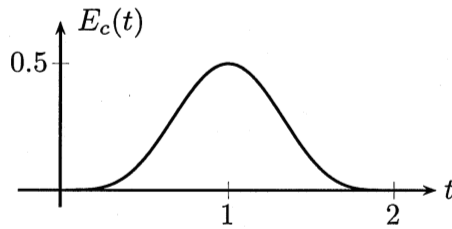

Figure 1.24: Energy stored in the capacitor as a function of time.

(iii) It supplies power when the slope of the energy curve is negative, which occurs for  $1 < t < 2$ .

(iv) It absorbs power when the slope of the energy curve is positive, which occurs for  $0 < t < 1$ .

(b) (i) For values of  $t$  in the range  $0 < t < 2$  we can write

$$\begin{aligned} i_\ell(t) &= \int_0^t v_\ell(\tau) d\tau + i_\ell(0) \\ &= \int_0^t \frac{1}{2}(1 - \cos \pi \tau) d\tau \\ &= \frac{1}{2}t + \frac{1}{2\pi} \sin \pi t. \end{aligned}$$

For  $t > 2$ , the current remains constant at 1A and for  $t < 0$  it is constant at 0A. Therefore,

$$i_\ell(t) = \begin{cases} 0, & t < 0 \\ \frac{1}{2}t + \frac{1}{2\pi} \sin \pi t, & 0 < t < 2 \\ 1, & 2 < t. \end{cases}$$

This is shown in Figure 1.25.

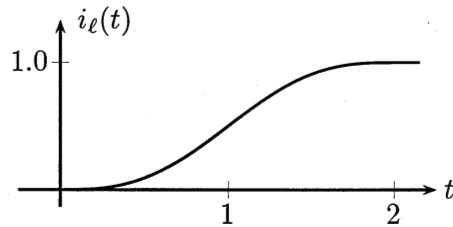

Figure 1.25: Inductor current as a function of time.

- (ii) The energy stored in the inductor is  $\frac{1}{2}Li_\ell^2(t) = \frac{1}{2}i_\ell^2(t)$ , which is shown in Figure 1.26.

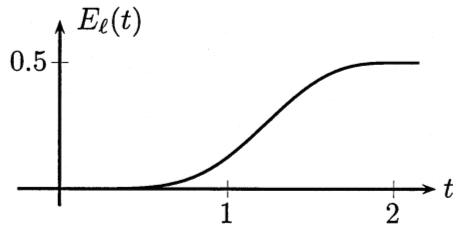

Figure 1.26: Energy stored in the inductor as a function of time.

- (iii) The inductor absorbs power (absorbs energy) for  $0 < t < \infty$ .  
 (iv) There are no values of  $t$  for which the inductor is supplying power.

### P-1.22 (2)

- (a) The voltage,  $v_\ell(t)$  measured between the terminals of an ideal 2H inductor is

$$v_\ell(t) = 6e^{-2t} + 3e^{-3t} \text{ mV.}$$

The inductor current,  $i_\ell(t)$ , at  $t = 0$  is zero. Determine  $i_\ell(t)$ .

- (b) Repeat for the voltage shown in Figure 1.27.

#### Solution:

- (a) The current flowing through the inductor is

$$\begin{aligned} i(t) &= 500 \int_0^t v(\tau) d\tau \\ &= 500 \int_0^t (6e^{-2\tau} + 3e^{-3\tau})10^{-3} d\tau \\ &= -(1.5e^{-2t} + .5e^{-3t})A. \end{aligned}$$

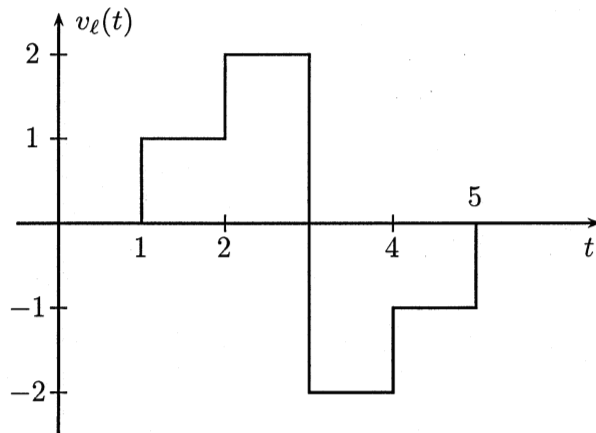
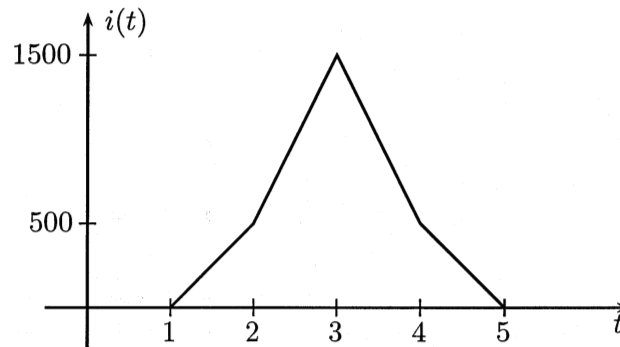
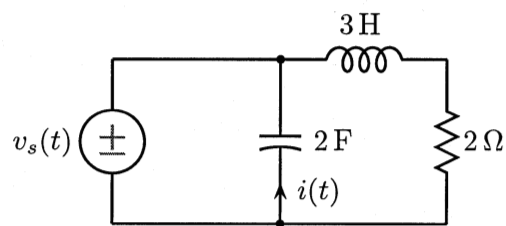

Figure 1.27: Voltage waveform for Problem P-1.22.

(b) The easiest way to show this part is graphically.



**P-1.23 (2,6)** The source waveform  $v_s(t)$  applied to the circuit in Figure 1.28a is shown in Figure 1.28b. Sketch the current  $i(t)$  flowing through the capacitor as a function of time.



(a)

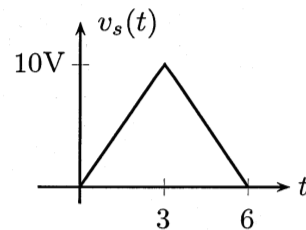

(b)

Figure 1.28: (a) Circuit for Problem P-1.23. (b) Voltage source waveform  $v_s(t)$ .

---

**Solution:** The inductor and the resistor do not affect the capacitor current and can be ignored. The voltage of the capacitor is  $v_s(t)$ . If  $i_c(t)$  is defined to be the current flowing into the + terminal of the capacitor, then

$$i_c(t) = C \frac{dv_c(t)}{dt} = 2 \frac{dv_s(t)}{dt}$$

This current, however, is the negative of  $i(t)$ . Thus,

$$i(t) = -i_c(t) = -2 \frac{dv_s(t)}{dt}.$$

Performing the derivative amounts to measuring the slopes of the line segments that make up  $v_s(t)$ .

$$i(t) = \begin{cases} 0, & t < 0 \\ -20/3, & 0 < t < 3 \\ 20/3, & 3 < t < 6 \\ 0, & 6 < t \end{cases}$$

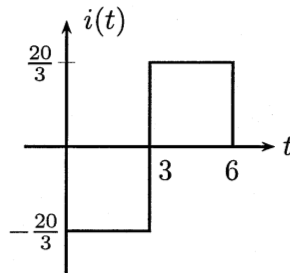

---

**P-1.24 (4,5)**

- Write the KCL equations that constrain the currents at all of the nodes of the network in Figure 1.29.
- Write the KVL equations that constrain the voltages for all of the meshes in that same network.

---

**Solution:**

- The network contains four nodes. If we write the KCL equations by summing the currents that enter the nodes, then the

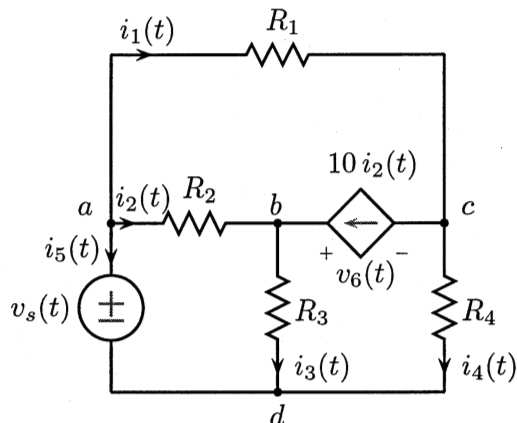

Figure 1.29: Circuit for Problem P-1.24.

four equations are:

$$\text{node } a: \quad -i_1(t) - i_2(t) - i_5(t) = 0$$

$$\text{node } b: \quad +i_2(t) + 10i_2(t) - i_3(t) = 0$$

$$\text{node } c: \quad +i_1(t) - 10i_2(t) - i_4(t) = 0$$

$$\text{node } d: \quad +i_3(t) + i_4(t) + i_5(t) = 0.$$

- (b) Let the resistor voltages be defined so that the current arrows are defined as pointing from the + to the - terminals. Then the KVL equations on the three meshes are:

$$\text{mesh 1:} \quad v_1(t) - v_6(t) - v_2(t) = 0$$

$$\text{mesh 2:} \quad -v_s(t) + v_2(t) + v_3(t) = 0$$

$$\text{mesh 3:} \quad -v_3(t) + v_6(t) + v_4(t) = 0.$$

Recall that the voltage for each resistor gets a + sign if the path goes in the direction of the current (i.e., downstream) and a - sign if the path is upstream.

### P-1.25 (4,5)

- (a) Write the KCL equations that constrain the currents at all of the nodes of the network in Figure 1.30. The time dependence of the element variables and currents has been suppressed to limit clutter.
- (b) Write the KVL equations that constrain the voltages for all of the meshes in that same network.

**Solution:**

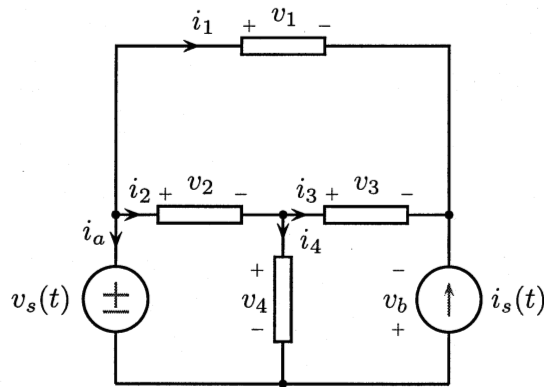

Figure 1.30: Circuit for Problem P-1.25.

- (a) There are four nodes in this circuit: upper left (a), upper middle (b), upper right (c), and lower (d).

$$\text{node } a: -i_a(t) - i_2(t) - i_1(t) = 0$$

$$\text{node } b: i_2(t) - i_3(t) - i_4(t) = 0$$

$$\text{node } c: i_3(t) + i_s(t) + i_1(t) = 0$$

$$\text{node } d: i_a(t) + i_4(t) - i_s(t) = 0$$

- (b) There are three meshes: upper (1), lower left (2), and lower right (3).

$$\text{mesh 1: } -v_s(t) + v_2(t) + v_4(t) = 0$$

$$\text{mesh 2: } -v_4(t) + v_3(t) - v_b(t) = 0$$

$$\text{mesh 3: } v_1(t) - v_3(t) - v_2(t) = 0$$

**P-1.26 (6)** Find the values of the voltages from the complete solution of the circuit in Figure 1.4.

**Solution:** From Problem P-1.4, the two KCL equations are

$$\text{node } b: \frac{v_1(t)}{2} - v_2(t) - v_3(t) = 0$$

$$\text{node } c: v_2(t) - \frac{v_4(t)}{2} = -i_s(t).$$

Writing KVL equations on the left two meshes provides the necessary two additional equations

$$\text{left mesh: } v_1(t) + v_3(t) = v_s(t)$$

$$\text{right mesh: } -v_3(t) + v_2(t) + v_4(t) = 0.$$

These four equations in four unknowns can be solved for  $v_1(t)$ ,  $v_2(t)$ ,  $v_3(t)$ , and  $v_4(t)$  in terms of  $v_s(t)$ . The solution is

$$\begin{aligned} v_1(t) &= \frac{8}{11}v_s(t) - \frac{4}{11}i_s(t) \\ v_2(t) &= \frac{1}{11}v_s(t) - \frac{6}{11}i_s(t) \\ v_3(t) &= \frac{3}{11}v_s(t) + \frac{4}{11}i_s(t) \\ v_4(t) &= \frac{2}{11}v_s(t) + \frac{10}{11}i_s(t). \end{aligned}$$

**P-1.27 (6)** Find the values of the currents from the complete solution of the circuit in Figure 1.6.

**Solution:** From Problem P-1.8, we have KVL equations for the two left meshes:

$$\text{left mesh: } 2i_1(t) - i_3(t) = v_s(t)$$

$$\text{right mesh: } i_2(t) + i_3(t) - i_4(t) = 0.$$

We can add two KCL equations at the two non-trivial nodes at the top of the circuit. (The left node merely tells us that the current flowing through the voltage source is the same as the current flowing through the  $2\Omega$  resistor.)

$$\text{node } a: \quad i_1(t) - i_2(t) + i_3(t) = 0$$

$$\text{node } b: \quad i_2(t) + i_4(t) = -i_s(t).$$

This gives four equations in the four unknown currents. We can solve for the currents in terms of  $v_s(t)$  and  $i_s(t)$ . The algebra of the solution is omitted, but the solution is:

$$\begin{aligned} i_1(t) &= \frac{3}{8}v_s(t) - \frac{1}{8}i_s(t) \\ i_2(t) &= \frac{1}{8}v_s(t) - \frac{3}{8}i_s(t) \\ i_3(t) &= -\frac{1}{4}v_s(t) - \frac{1}{4}i_s(t) \\ i_4(t) &= -\frac{1}{8}v_s(t) - \frac{5}{8}i_s(t) \end{aligned}$$

**P-1.28 (6)** Find the values of the currents for the circuit in Figure 1.2.

**Solution:** In Problem P-1.2 we found the two KCL equations for this circuit:

$$\text{node } a: \quad i_1(t) - i_2(t) - i_3(t) = 0$$

$$\text{node } b: \quad i_3(t) + 10i_1(t) - i_4(t) = 0$$

Let the voltage across the dependent source be  $v(t)$ . Then we can write KVL equations over the three meshes using  $v(t)$  and the current variables. The results are

$$\text{left mesh:} \quad 5i_1(t) + 10i_2(t) = v_s(t)$$

$$\text{center mesh:} \quad -10i_2(t) + 30i_3(t) + v(t) = 0$$

$$\text{right mesh:} \quad -v(t) + i_4(t) = 0$$

Adding the last two equations eliminates  $v(t)$ . The remaining four equations can be written in matrix-vector form (See Section 2-3.3.) as:

$$\begin{bmatrix} 1 & -1 & -1 & 0 \\ 10 & 0 & 1 & -1 \\ 5 & 10 & 0 & 0 \\ 0 & -10 & 30 & 1 \end{bmatrix} \begin{bmatrix} i_1(t) \\ i_2(t) \\ i_3(t) \\ i_4(t) \end{bmatrix} = \begin{bmatrix} 0 \\ 0 \\ 1 \\ 0 \end{bmatrix} v_s(t)$$

Using MATLAB the solution is readily found to be

$$\begin{bmatrix} i_1(t) \\ i_2(t) \\ i_3(t) \\ i_4(t) \end{bmatrix} = \begin{bmatrix} 1/15 \\ 1/15 \\ 0 \\ 2/3 \end{bmatrix} v_s(t).$$

**P-1.29 (6)** Find the values of the voltages in the circuit in Figure 1.5.

**Solution:** From the solution to Problem P-1.6 we have the following KVL equations

$$-v(t) + v_1(t) = 0$$

$$-0.9v_1(t) + v_2(t) = 0.$$



To these we can add a KCL equation

$$\frac{1}{5}v_1(t) + \frac{1}{5}v_2(t) = i_s(t).$$

If we multiply the KCL equation by five and subtract the second KVL equation, we get

$$1.9v_1(t) = 5i_s(t).$$

Using this result we get

$$v_1(t) = 2.632 i_s(t)$$

$$v_2(t) = 2.368 i_s(t)$$

$$v(t) = v_1(t) = 2.632 i_s(t).$$

**P-1.30 (4,5,6)** In the circuit of Figure 1.31 determine  $v(t)$  as a function of  $v_{s_1}(t)$ ,  $v_{s_2}(t)$  and  $i_s(t)$ .

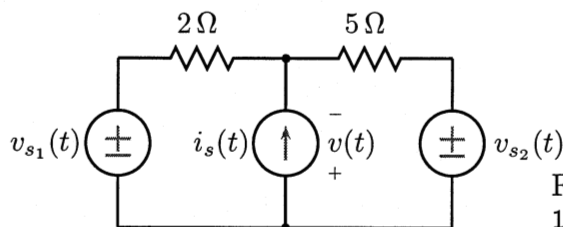

Figure 1.31: Circuit for Problem P-1.30.

**Solution:** Writing a KCL equation (incorporating Ohm's Law and KVL) at the upper node gives

$$\frac{1}{5}[-v(t) - v_{s_2}(t)] + \frac{1}{2}[-v(t) - v_{s_1}(t)] = i_s(t).$$

Solving for  $v(t)$  gives the result

$$v(t) = -\frac{5}{7}v_{s_1}(t) - \frac{2}{7}v_{s_2}(t) - \frac{10}{7}i_s(t).$$

**P-1.31 (4,5 6)** In the circuit in Figure 1.32 both source waveforms (and all of the element variables) are constant. Compute the values of  $i_1$ ,  $v_1$ ,  $i_2$ , and  $v_2$ .

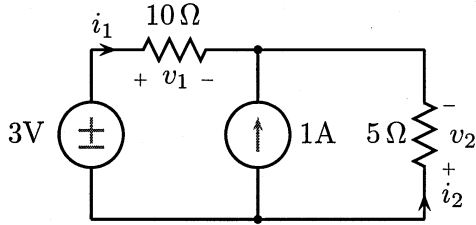

Figure 1.32: Circuit for Problem P-1.31.

**Solution:** Observe that the voltage across the current source is  $v_2$  and that the current through the voltage source is  $i_1$ . This means that we do not need one KCL equation and one KVL equation. We *will* need two element relations, one KCL equation, and one KVL equation.

$$R_1 : v_1 = 10i_1$$

$$R_2 : v_2 = 5i_2$$

$$\text{KCL: } i_1 + 1 + i_2 = 0$$

$$\text{KVL: } -3 + v_1 + v_2 = 0$$

The solution of these equations is

$$i_1 = -2/15 \quad v_1 = -4/3$$

$$i_2 = -13/15 \quad v_2 = -13/3.$$

**P-1.32 (4,5,6)** Consider the circuit in Figure 1.33.

- (a) What is  $i_1(t)$ ? (in terms of  $v_s(t)$ )  
 (b) What is  $v_2(t)$ ?

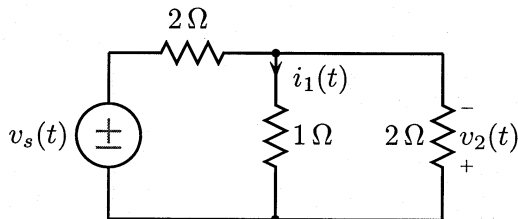

Figure 1.33: Circuit for Problem P-1.32.

---

**Solution:** We have labelled some additional variables on the above circuit.

- (a) There are six element variables. To solve for these we write three element relations, two KVL equations, and one KCL equation.

$$R_1 : v_1(t) = i_1(t)$$

$$R_2 : v_2(t) = -2i_2(t) \text{ note reference directions}$$

$$R_3 : v_3(t) = 2i_3(t)$$

$$\text{KVL1: } -v_s(t) + v_3(t) + v_1(t) = 0$$

$$\text{KVL2: } -v_1(t) - v_2(t) = 0$$

$$\text{KCL: } i_1(t) + i_2(t) - i_3(t) = 0$$

Eliminating the voltage variables, these become

$$\text{KVL1: } i_1(t) + 2i_3(t) = v_s(t)$$

$$\text{KVL2: } i_1(t) - 2i_2(t) = 0$$

$$\text{KCL: } i_1(t) + i_2(t) - i_3(t) = 0.$$

We can express  $i_3(t)$  in terms of  $i_1(t)$  from the first equation, express  $i_2(t)$  in terms of  $i_1(t)$  from the second, and substitute into the third to solve for  $i_1(t)$ . This gives

$$i_1(t) = \frac{1}{4}v_s(t)$$

- (b) From the solution in part (a), we know

$$v_1(t) = i_1(t) = \frac{1}{4}v_s(t)$$

$$v_2(t) = -v_1(t) = -\frac{1}{4}v_s(t)$$

---

**P-1.33 (4,5,6)** Solve the circuit in Figure 1.34 for  $v_1(t)$ ,  $v_2(t)$ , and  $v_3(t)$ .

---

**Solution:** We need to write two KCL equations and one KVL equation. If we write these in terms of the voltage variables, we save some effort.

$$\text{KCL1: } \frac{v_1(t)}{5} + \frac{v_2(t)}{2} = \sin 30t$$

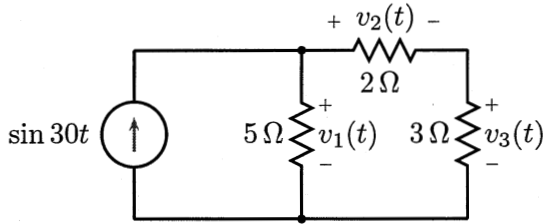

Figure 1.34: Circuit for Problem P-1.33.

$$\text{KCL2: } \frac{v_2(t)}{2} - \frac{v_3(t)}{3} = 0$$

$$\text{KVL: } -v_1(t) + v_2(t) + v_3(t) = 0$$

From the second equation we know that  $v_3(t) = \frac{3}{2}v_2(t)$ . Substituting this fact into the third equation gives

$$-v_1(t) + v_2(t) + \frac{3}{2}v_2(t) = 0$$

from which we learn that  $v_1(t) = \frac{5}{2}v_2(t)$ . Substituting this fact into the first equation gives

$$\frac{v_2(t)}{2} + \frac{v_2(t)}{2} = \sin 30t$$

or

$$v_2(t) = \sin 30t.$$

Therefore, the other two voltages are

$$v_1(t) = \frac{5}{2} \sin 30t$$

$$v_3(t) = \frac{3}{2} \sin 30t.$$

**P-1.34 (4,5,6)** For the circuit of Figure 1.35, express  $v(t)$  in terms of  $i_s(t)$ .

**Solution:** Let  $v_1(t)$  be the voltage across the  $12\Omega$  resistor (top-to-bottom) and let  $v_2(t)$  be the voltage across the  $2\Omega$  resistor (left-to-right). Note that  $v(t)$  is the voltage across both the  $6\Omega$  and the  $12\Omega$  resistors. From KVL in the middle mesh

$$-v_1(t) + v_2(t) + v(t) = 0.$$

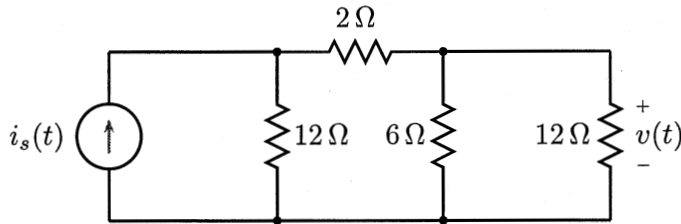

Figure 1.35: Circuit for Problem P-1.34.

From KCL at the top left node

$$\frac{1}{12}v_1(t) + \frac{1}{2}v_2(t) = i_s(t).$$

From KCL at the top right node

$$\frac{1}{2}v_2(t) - \frac{1}{6}v(t) - \frac{1}{12}v(t) = 0.$$

From the last equation, we learn that

$$v_2(t) = \frac{1}{2}v(t).$$

If we substitute this result into the top equation, we see that

$$v_1(t) = \frac{3}{2}v(t).$$

Substituting for  $v_1(t)$  and  $v_2(t)$  into the remaining equation gives

$$\frac{1}{8}v(t) + \frac{1}{4}v(t) = i_s(t)$$

or

$$v(t) = \frac{8}{3}i_s(t).$$

### P-1.35 (4,5,6)

- Determine the current  $i(t)$  in terms of  $v_s(t)$  in the circuit of Figure 1.36 when the switch is in the *open* position.
- Determine that same current when the switch is *closed*.

**Solution:**

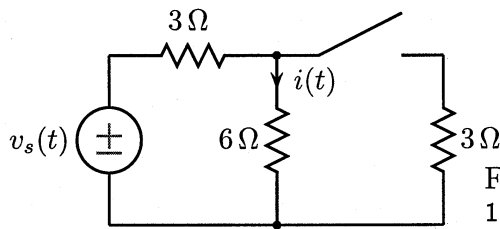

Figure 1.36: Circuit for Problem P-1.35, which contains a switch.

- (a) When the switch is open, no current flows through the vertical  $3\Omega$  resistor on the right. As a result the current through the voltage source and the current through both remaining resistors is  $i(t)$ . A KVL equation written around the mesh on the left gives

$$3i(t) + 6i(t) = v_s(t),$$

from which we see that

$$i(t) = \frac{1}{9}v_s(t).$$

- (b) When the switch is closed, let the current  $i_1(t)$  flow through the vertical  $3\Omega$  resistor. Writing a KVL equation on the mesh on the right gives

$$-6i(t) + 3i_1(t) = 0,$$

from which we conclude that

$$i_1(t) = 2i(t).$$

Observe now that the current flowing through the horizontal resistor is  $i(t) + i_1(t) = 3i(t)$ . Writing a KVL equation on the left mesh gives

$$3(3i(t)) + 6i(t) = v_s(t),$$

which we can solve to get

$$i(t) = \frac{1}{15}v_s(t).$$

Because of the simplicity of this circuit, the approach that we used alternated stages of setting up equations and solving them to hold down the number of variables. We could, alternatively, have defined three voltages across the terminals of the three resistors and three currents flowing through them. We could then have written three element relations, two KVL equations, and one KCL equation and solved these six equations for the six element variables. The result, of course, would be the same.

**P-1.36 (4,5,6)**

- (a) Determine the voltage  $v(t)$  in terms of  $v_s(t)$  in the circuit of Figure 1.37 when the switch is *closed*.
- (b) Determine that same voltage when the switch is *open*.

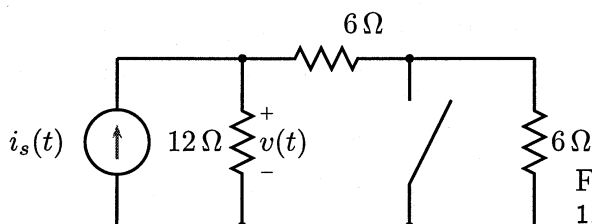

Figure 1.37: Circuit for Problem P-1.36, which also contains a switch.

**Solution:**

- (a) When the switch is closed, there is no voltage across the vertical  $6\Omega$  and, therefore, there is also no current flowing through it. The voltage across the terminals of the horizontal  $6\Omega$  resistor is  $v(t)$ . Writing a KCL equation at the node where the current source, the  $12\Omega$  resistor, and the horizontal resistor are joined gives

$$\frac{1}{12}v(t) + \frac{1}{6}v(t) = i_s(t),$$

or

$$v(t) = 4i_s(t).$$

- (b) When the switch is open, let  $i(t)$  denote the current flowing through both  $6\Omega$  resistors. The current flowing down through the  $12\Omega$  resistor is  $v(t)/12$ . A KCL equation written at the same node that we used in part (a) gives

$$\frac{1}{12}v(t) + i(t) = i_s(t).$$

A KVL equation around the mesh containing the three resistors written in terms of the same variables gives

$$6i(t) + 6i(t) - v(t) = 0 \implies i(t) = \frac{1}{12}v(t).$$

Substituting for  $i(t)$  in the KCL equation gives us the answer that we are looking for

$$\frac{1}{12}v(t) + \frac{1}{12}v(t) = i_s(t) \implies v(t) = 6i_s(t).$$

---

**P-1.37 (2,3)**

- (a) If a  $1\text{k}\Omega$  resistor and a  $2\text{k}\Omega$  resistor are connected in series, which will absorb more power?
- (b) If a  $1\text{k}\Omega$  resistor and a  $2\text{k}\Omega$  resistor are connected in parallel, which will absorb more power?

---

**Solution:**

- (a) If two resistors are connected in series, the same current passes through them. Let that current be  $i(t)$ . Then the power absorbed by the  $1\text{k}\Omega$  resistor is

$$P_1(t) = 1000i^2(t)$$

and the power absorbed by the  $2\text{k}\Omega$  resistor is

$$P_2(t) = 2000i^2(t),$$

which is twice as great. Therefore, more power is absorbed by the  $2\text{k}\Omega$  resistor.

- (b) If two resistors are connected in parallel, the same voltage appears across both. Let that voltage be  $v(t)$ . Then the power absorbed by the  $1\text{k}\Omega$  resistor is

$$P_1(t) = \frac{1}{1000}v^2(t)$$

and the power absorbed by the  $2\text{k}\Omega$  resistor is

$$P_2(t) = \frac{1}{2000}v^2(t),$$

which is only half as much. Thus in this case more power is absorbed in the  $1\text{k}\Omega$  resistor, which is just the opposite of what we saw in (a).

---



**P-1.38 (2,3)** Two  $1\mu\text{F}$  capacitors are connected to a battery. Will they store more energy if they are connected in series or in parallel?

---

**Solution:** Let the voltage of the battery be  $V$ . The energy stored in a capacitor is  $\frac{1}{2}CV^2$ . When the two capacitors are connected in parallel,

$$V_{c1} = V_{c2} = V$$

and the total energy stored is

$$E_{\text{parallel}} = \frac{1}{2}CV^2 + \frac{1}{2}CV^2 = CV^2.$$

When the two capacitors are connected in series, KVL says that

$$V_{c1} + V_{c2} = V.$$

Then the total energy stored is given by

$$\begin{aligned} E_{\text{series}} &= \frac{1}{2}CV_{c1}^2 + \frac{1}{2}C(V - V_{c1})^2 \\ &= \frac{1}{2}CV^2 - CVV_{c1} + CV_{c1}^2 \\ &= \frac{1}{2}E_{\text{parallel}} - CV_{c1}V_{c2}, \end{aligned}$$

which is always less than  $E_{\text{parallel}}$ . The capacitors will settle to the minimum energy state, which occurs when  $V_{c1} = V_{c2} = V/2$ . Then, the energy stored in the series connection will be only one-fourth of that stored in the parallel connection.

---

**P-1.39 (4,5,6)** The circuit in Figure 1.38 contains a current-controlled voltage source. Write a sufficient set of KVL equations to specify the element voltage constraints over all closed paths in the circuit using the variables  $v_1(t)$ ,  $v_2(t)$ ,  $v_3(t)$  and  $v_s(t)$ . ( $i_1(t)$  is the current flowing into the + terminal of the  $5\Omega$  resistor.)

---

**Solution:** First, we need to use the fact that  $i_1(t) = v_1(t)/5$  to turn the current-controlled voltage source into a voltage-controlled voltage source (with voltage  $2v_1(t)$ ). Then, we can write KVL equations over the two meshes.

$$\begin{aligned} \text{left mesh:} \quad & v_1(t) + v_2(t) = v_s(t) \\ \text{right mesh:} \quad & -v_2(t) + v_3(t) + v_4(t) + 2v_1(t) = 0 \end{aligned}$$

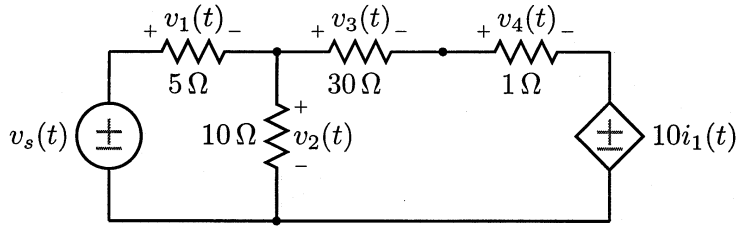

Figure 1.38: Circuit for Problems P-1.39 and P-1.40.

---

**P-1.40 (2,4,5,6)** Find the values of the voltage in the circuit in Figure 1.38.

---

**Solution:** From the solution to Problem P-1.39 we have the two KVL equations

$$\begin{aligned} v_1(t) + v_2(t) &= v_s(t) \\ -v_2(t) + v_3(t) + v_4(t) + 2v_1(t) &= 0. \end{aligned}$$

To these we add two KCL equations (written using the voltage variables):

$$\begin{aligned} \frac{v_3(t)}{30} - \frac{v_4(t)}{40} &= 0 \implies 4v_3(t) - 3v_4(t) = 0 \\ \frac{v_1(t)}{5} - \frac{v_2(t)}{10} - \frac{v_3(t)}{30} &= 0 \implies 6v_1(t) - 3v_2(t) - v_3(t) = 0. \end{aligned}$$

Putting these in matrix-vector form gives

$$\begin{bmatrix} 1 & 1 & 0 & 0 \\ 2 & -1 & 1 & 1 \\ 0 & 0 & 4 & -3 \\ 6 & -3 & -1 & 0 \end{bmatrix} \begin{bmatrix} v_1(t) \\ v_2(t) \\ v_3(t) \\ v_4(t) \end{bmatrix} = \begin{bmatrix} 1 \\ 0 \\ 0 \\ 0 \end{bmatrix} v_s(t).$$

Using MATLAB the solution is readily found to be

$$\begin{bmatrix} i_1(t) \\ i_2(t) \\ i_3(t) \\ i_4(t) \end{bmatrix} = \begin{bmatrix} 1/3 \\ 2/3 \\ 0 \\ 0 \end{bmatrix} v_s(t).$$

---

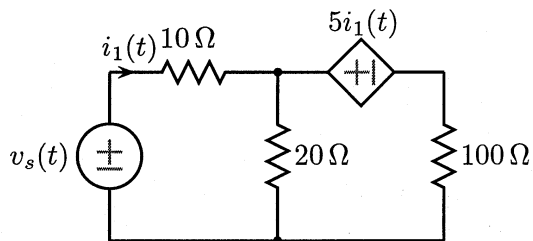

Figure 1.39: Circuit for Problem P-1.41.

**P-1.41 (1,4,5,6)** Find the current  $i_1(t)$  for the circuit shown in Figure 1.39. (You will need to define some additional variables.)

---

**Solution:** Define the auxiliary currents shown in Figure 1.40. From

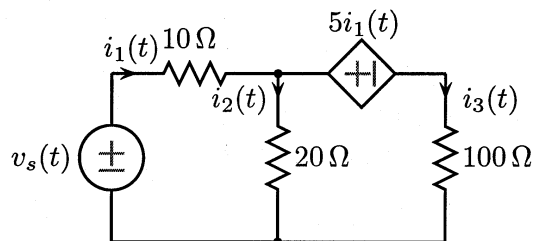

Figure 1.40: Circuit for Problem P-1.41 with additional currents labelled.

KCL

$$i_1(t) - i_2(t) - i_3(t) = 0. \quad (1.4)$$

From KVL applied to the left mesh

$$-v_s(t) + 10i_1(t) + 20i_2(t) = 0 \quad (1.5)$$

and from KVL applied to the right mesh

$$-20i_2(t) + 5i_1(t) + 100i_3(t) = 0. \quad (1.6)$$

Remember the dependent source is a *voltage* source with a voltage that is equal to  $5i_1(t)$ . From the first equation  $i_3(t) = i_1(t) - i_2(t)$ . Substituting into the second and third equations, this gives

$$10i_1(t) + 20i_2(t) = v_s(t)$$

$$105i_1(t) - 120i_2(t) = 0.$$

We can now multiply the first equation by six and add the two equations together.

$$165i_1(t) = 6v_s(t)$$

or

$$i_1(t) = \frac{6}{165}v_s(t) = \frac{2}{55}v_s(t).$$

**P-1.42 (1,4,5,6)** Determine the voltage  $v(t)$  in the circuit in Figure 1.41.

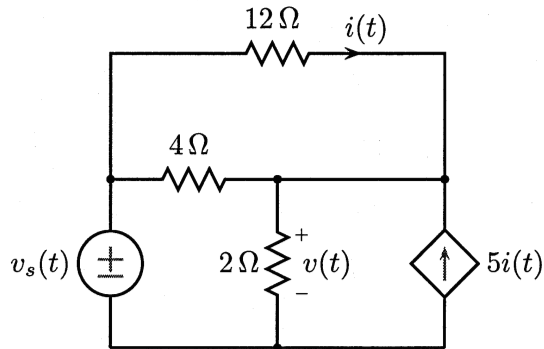
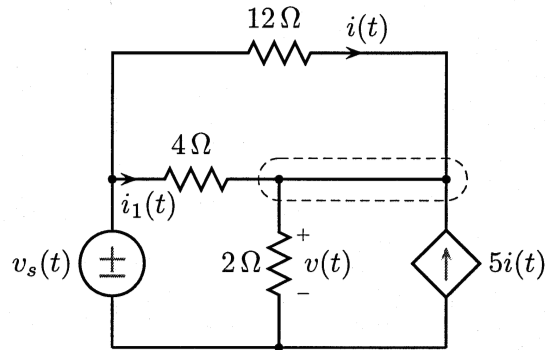

Figure 1.41: Figure for Problem P-1.42.

**Solution:** In the figure below we indicate some additional variables.



Notice that we have let the current flowing through the  $4\Omega$  resistor be denoted by  $i_1(t)$ . The current flowing downward through the  $2\Omega$  resistor is  $v(t)/2$ . We can set up one KCL equation (at the circled node), and two KVL equations to solve for the three variables  $i(t)$ ,  $v(t)$ , and  $i_1(t)$ .

$$\text{KCL: } i_1(t) + 6i(t) - \frac{1}{2}v(t) = 0$$

$$\text{KVL } \alpha: 4i_1(t) + v(t) = v_s(t)$$

$$\text{KVL } \beta: 12i(t) - 4i_1(t) = 0.$$

From the third equation

$$i_1(t) = 3i(t).$$

Substituting this fact into the first equation gives

$$9i(t) - \frac{1}{2}v(t) = 0 \implies i(t) = \frac{1}{18}v(t).$$

Finally, substituting this result into the second equation gives

$$\frac{12}{18}v(t) + v(t) = v_s(t)$$

or

$$v(t) = \frac{3}{5}v_s(t).$$

**P-1.43 (3,4,5,6)** For the circuit in Figure 1.42

- Compute the power *absorbed* by the independent voltage source.
- Compute the power *absorbed* by the dependent current source.

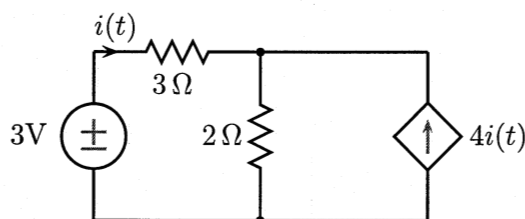

Figure 1.42: Circuit for Problem P-1.43.

**Solution:** Since the only independent source waveform is constant, all of the voltages and currents in this circuit will be constant as a function of  $t$ . Let  $i'$  denote the current flowing (downward) through the  $2\Omega$  resistor. From KCL at the top node

$$i + 4i = i' \implies i' = 5i.$$

By KVL

$$3i + 2i' = 3.$$

If we substitute for  $i'$ , this gives

$$13i = 3 \implies i = \frac{3}{13}A; \quad i' = \frac{15}{13}A.$$

- (a) The power absorbed by the voltage source is the product of its voltage (3V) and the current entering its + terminal ( $-i$ ). Thus,

$$P_v = -(3)\left(\frac{3}{13}\right) = -\frac{9}{13}W.$$

- (b) The power absorbed by the dependent current source is the product of its voltage ( $2i'$ ) and the current entering its + terminal ( $-4i$ ). Therefore,

$$P_i = -8\left(\frac{15}{13}\right)\left(\frac{3}{13}\right) = -\frac{360}{169}$$

**P-1.44 (4,5,6)** In the circuit in Figure 1.43, which contains a voltage-dependent current source, determine  $v(t)$ .

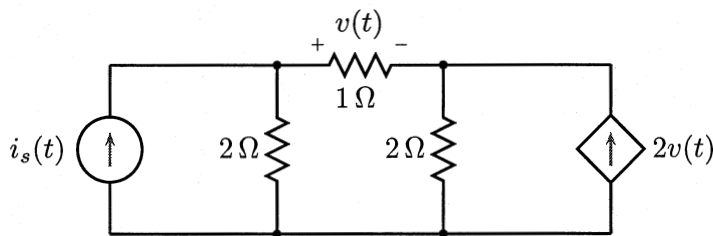

Figure 1.43: Circuit for Problem P-1.44.

**Solution:** We could solve this problem by setting up and solving the usual set of KVL equations, KCL equations, and element relations. There is nothing wrong with approaching this problem that way. An alternative, however, is to evaluate some of the voltages and currents in the circuit whose value can be immediately determined and then use these values to evaluate others. That is the approach discussed here.

The current flowing left to right through the horizontal  $1\Omega$  resistor is  $v(t)$ . Since a current  $2v(t)$  comes from the dependent current source, KCL tells us that a current of  $3v(t)$  must flow through the rightmost  $2\Omega$  resistor from top to bottom. This will induce a voltage of  $6v(t)$ . This means that there is a voltage of  $7v(t)$  across the leftmost  $2\Omega$  resistor (by KVL) and a current of  $\frac{7}{2}v(t)$  flowing through it. Since the current through the horizontal resistor was  $v(t)$ , by KCL we have finally

$$v(t) + \frac{7}{2}v(t) = i_s(t)$$

or

$$v(t) = \frac{2}{9}i_s(t).$$

**P-1.45 (4,5,6)** Find  $v(t)$ , the potential difference between the two indicated nodes, for the circuit in Figure 1.44.

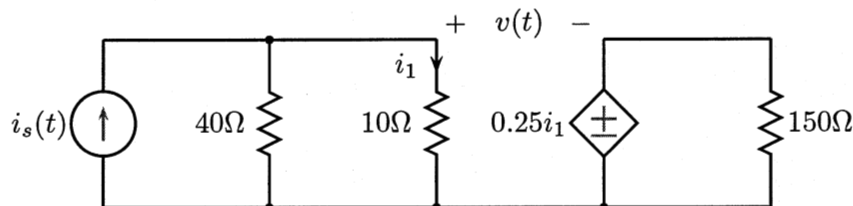

Figure 1.44: Circuit for Problem P-1.45.

**Solution:** Let  $i_2(t)$  be the current flowing down through the  $40\Omega$  resistor. Then, from KCL

$$i_1(t) + i_2(t) = i_s(t)$$

and from KVL

$$\begin{aligned} 10i_1(t) - 40i_2(t) &= 0 \\ \Rightarrow i_2(t) &= \frac{1}{4}i_1(t). \end{aligned}$$

Substituting this result into the KCL equation gives

$$\begin{aligned} i_1(t) + \frac{5}{4}i_1(t) &= i_s(t) \\ \Rightarrow i_1(t) &= \frac{4}{5}i_s(t). \end{aligned}$$

We can now write a KVL equation around the closed path containing the  $10\Omega$  resistor, the dependent source, and the open circuit across which  $v(t)$  is defined.

$$10i_1(t) - \frac{1}{4}i_1(t) = v(t).$$

Thus,

$$v(t) = \frac{39}{4}i_1(t) = \frac{39}{5}i_s(t).$$

## Advanced Problems

**P-1.46 (2)** In the circuit of Figure 1.45 both inductors have no current flowing through them at  $t = 0$ .

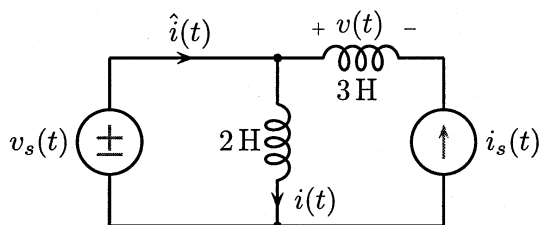

Figure 1.45: Circuit for Problem P-1.46.

(a) If

$$i_s(t) = \begin{cases} \sin 3t, & t \geq 0 \\ 0, & t < 0, \end{cases}$$

what is  $v(t)$ ?

(b) If

$$v_s(t) = \begin{cases} e^{-3t}, & t \geq 0 \\ 0, & t < 0, \end{cases}$$

what is  $i(t)$ ?

(c) With both sources turned on as indicated in (a) and (b), what is  $\hat{i}(t)$ ?

---

### Solution:

(a) For an inductor

$$v_\ell(t) = L \frac{di_\ell(t)}{dt}.$$

Therefore,

$$\begin{aligned} v(t) &= -3 \frac{di_s(t)}{dt} = -3 \frac{d}{dt} \begin{cases} \sin 3t, & t \geq 0 \\ 0, & t < 0 \end{cases} \\ &= \begin{cases} -9 \cos 3t, & t \geq 0 \\ 0, & t < 0. \end{cases} \end{aligned}$$



(b)

$$i_L(t) = \frac{1}{L} \int_0^t v(\tau) d\tau + i_L(0).$$

Therefore,

$$i(t) = \frac{1}{2} \int_0^t v_s(\tau) d\tau = \begin{cases} \frac{1}{6}(1 - e^{-3t}), & t \geq 0 \\ 0, & t < 0. \end{cases}$$

(c)  $\hat{i}(t) + i_s(t) = i(t)$ . Therefore,

$$\begin{aligned} \hat{i}(t) &= i(t) - i_s(t) \\ &= \begin{cases} \frac{1}{6}(1 - e^{-3t}) - \sin 3t, & t \geq 0 \\ 0, & t < 0. \end{cases} \end{aligned}$$

**P-1.47 (2,3)** Consider the circuit in Figure 1.46. The waveforms corresponding

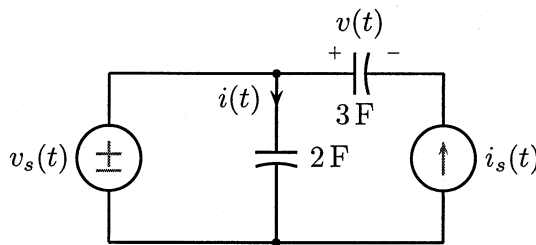

Figure 1.46: Circuit for Problem P-1.47.

to the source signals are given graphically in Figure 1.47.

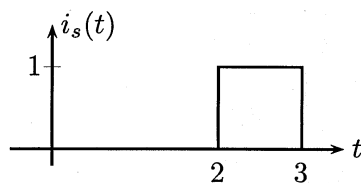
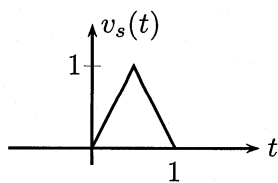
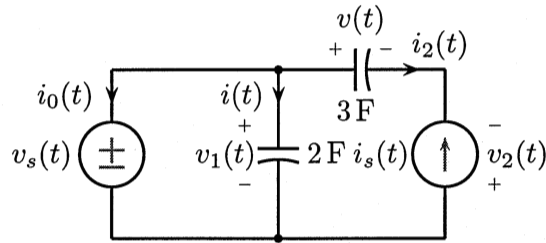

Figure 1.47: Voltage and current source waveforms for Problem P-1.47.

- Determine the current  $i(t)$ . Express your result as a graph of the current versus time.
- Determine the voltage  $v(t)$ . Express your result as a graph of the voltage versus time.

- (c) Draw a graph of the instantaneous power absorbed by the voltage source versus time.
- (d) Draw a graph of the instantaneous power absorbed by the current source versus time.

**Solution:** Before we begin, it is helpful to define some additional variables in the circuit. This is done in the following figure.



- (a) By KVL,  $v_1(t) = v_s(t)$ . From the element relation for the capacitor

$$i(t) = 2 \frac{dv_1(t)}{dt} = 2 \frac{dv_s(t)}{dt}.$$

The graph of this function is shown below.

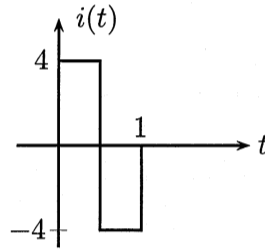

- (b) From KCL  $i_2(t) = -i_s(t)$ . From the element relation of the 3 F capacitor,

$$v(t) = \frac{1}{3} \int_2^t i_2(\tau) d\tau + v(2).$$

Assuming that  $v(2) = 0$ , this means that

$$v(t) = -\frac{1}{3} \int_2^t i_s(\tau) d\tau.$$

Its graph is shown below.

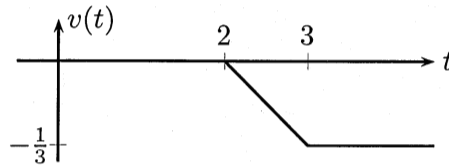

- (c) The instantaneous power absorbed by the voltage source is  $P_{inst}(t) = v_s(t)i_0(t)$ . To get  $i_0(t)$  we can apply KCL

$$i_0(t) + i(t) = i_s(t) \implies i_0(t) = i_s(t) - i(t).$$

Thus, the graph of  $i_0(t)$  is

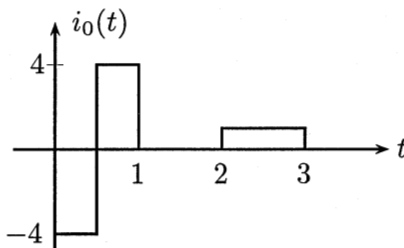

and the graph of  $P_{inst}(t)$  is

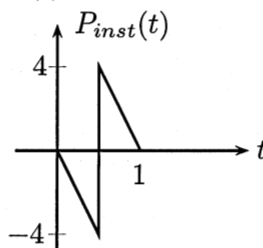

- (d) The instantaneous power absorbed by the current source is

$$\hat{P}_{inst}(t) = v_2(t)i_s(t). \quad (1.7)$$

Furthermore, by KVL we know that

$$v(t) - v_2(t) - v_s(t) = 0$$

or that

$$v_2(t) = v(t) - v_s(t).$$

This waveform is graphed below.

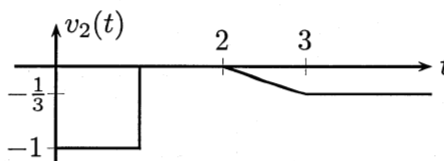

From this graph and (1.7), we can draw the graph of the instantaneous absorbed power.

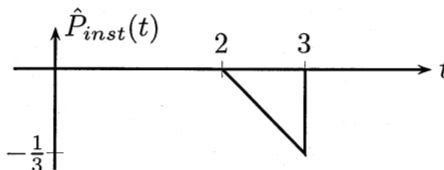

---

**P-1.48 (2,3)** Determine the value of the resistance  $R$  in the circuit in Figure 1.48 for which the instantaneous power absorbed by that resistor,  $P_{inst}$  is maximized. *Hint:* To find the value of  $R$  for which  $P_{inst}(R)$  is maximized, set the derivative of  $P_{inst}(R)$  to zero.

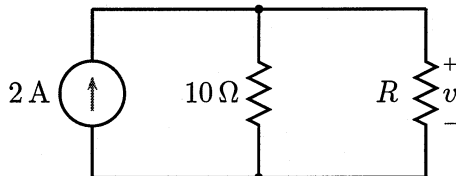

Figure 1.48: Circuit for Problem P-1.48.

---

**Solution:** The instantaneous power absorbed by the resistor is

$$P_{inst} = \left( \frac{20R}{10 + R} \right)^2 \cdot \frac{1}{R} = \frac{400R}{(10 + R)^2}$$

$$\frac{dP_{inst}}{dt} = 0 = \frac{(10 + R)^2 \cdot 400 - 800R(10 + R)}{(10 + R)^2}.$$

Thus,

$$(10 + R)400 = 800R \implies R = 10\ \Omega.$$

---

**P-1.49 (4)** Consider the four-terminal network  $N_1$  shown in Figure 1.49a.

- When network  $N_1$  is connected to the two subnetworks  $N_2$  and  $N_3$  as shown in Figure 1.49b, what is the relation between currents  $i_1(t)$  and  $i_2(t)$ ?
- Does the result that you derived in (a) apply to  $i_1(t)$  and  $i_2(t)$  when  $N_1$  is embedded in a larger (but unknown) network as shown in Figure 1.49c? Explain.

---

**Solution:**

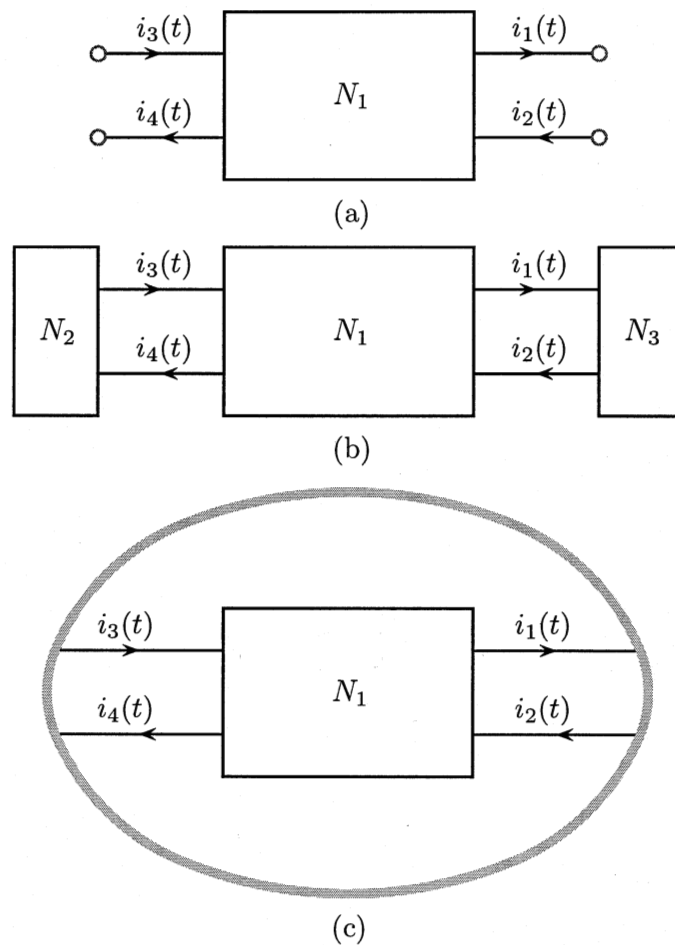

Figure 1.49: (a) A four-terminal network  $N_1$  for Problem P-1.50. (b)  $N_1$  connected to two two-terminal networks. (c)  $N_1$  embedded into a more general network.

- (a) If we enclose the subnetwork  $N_2$  by a surrounding surface, we can apply KCL and derive the constraint

$$i_3(t) - i_4(t) = 0 \implies i_3(t) = i_4(t).$$

Similarly if we enclose the subnetwork  $N_3$  by such a surface, KCL will show that

$$i_1(t) = i_2(t).$$

- (b) Here the only constraint on the currents is the single KCL equation

$$i_1(t) - i_2(t) - i_3(t) + i_4(t) = 0.$$

$i_1(t)$  is not necessarily equal to  $i_2(t)$  and  $i_3(t)$  is not necessarily equal to  $i_4(t)$ .

**P-1.50 (5)** In the text it was claimed that the set of KVL equations formed on the closed paths that encircle the meshes in a planar network are independent. In this problem we prove this claim. A planar network is one that can be drawn on a piece of paper with none of the wires crossing each other. Our proof (and our methodology) is limited to planar networks because these are the only ones for which the concept of a mesh is defined. (Nonplanar circuits can be solved using the mesh method, which will be described in Chapter 2.)

- (a) Our proof proceeds by induction. Recall the basis behind these proofs.
1. Verify that the statement is true for  $\ell = 1$ .
  2. Assume that it is valid for  $\ell = k$ .
  3. Prove that if it is valid for  $\ell = k$ , then it must also be true for  $\ell = k + 1$ .

For this problem  $\ell$  corresponds to the number of meshes in a simplified circuit formed from the original by removing some of the elements. Begin by removing all of the interior elements from the network, leaving a single path going around the outside of the original circuit and write a KVL equation around that path. Since there is only a single equation, which is non-trivial, it is independent. This corresponds to Step 1 above. Next assume that several elements have been reinserted into the circuit so that the partially completed circuit now contains  $k$  meshes for whose paths the KVL equations are independent. This corresponds to Step 2. Finally, we add enough additional elements back into the circuit to create an additional mesh. This can only happen by dividing one of the meshes from the  $k^{\text{th}}$  stage, called the parent, into two meshes at the next stage, called the children. Let  $I$  equal the sum of the voltages across the inserted elements,  $A$  equal the sum of the voltages from the parent that go to child #1 and  $B$  equal the sum of the voltages that go to child #2.

- (i) Write a KVL equation for the path corresponding to the parent in terms of  $A$ ,  $B$ , and  $I$ .
- (ii) Write two KVL equations for the paths corresponding to the children in terms of  $A$ ,  $B$ , and  $I$ .
- (iii) Show that these two equations are independent, i.e., that neither can be derived from the other.
- (iv) Show that neither of these equations can be derived from the other meshes in the circuit at this level.

This completes the inductive proof.

- (b) Use the constructive procedure of your proof to verify that the KVL equations for the meshes in the network below are independent.

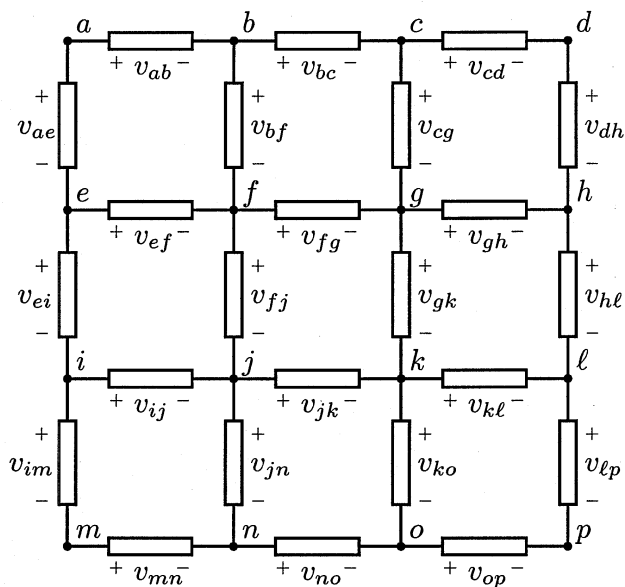

Figure 1.50: A network containing a number of elements for proving the independence of mesh equations in Problem P-1.50.

**Solution:** To help with visualization, consider the circuit shown in Figure 1.51.

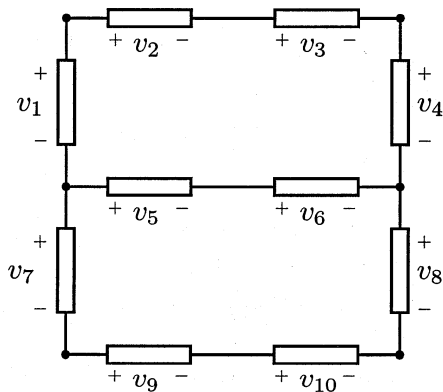

Figure 1.51: Figure to illustrate the inductive proof.

(a) For this circuit we define the following quantities

$$I = v_5 + v_6$$

$$A = -v_1 + v_2 + v_3 + v_4$$

$$B = v_8 - v_{10} - v_9 - v_7$$

(i) The original mesh at stage  $k$  is the outer path. Its KVL

equation is

$$A + B = 0.$$

- (ii) At the  $(k+1)^{st}$  stage we add the two branches in the center. The two KVL equations that result are:

$$A - I = 0$$

$$B + I = 0.$$

- (iii)  $A$  and  $B$  have no elements in common; hence they have no element voltages in common. Since there are element voltages in the first equation that do not appear in the second and vice-versa, neither of these equations can be derived from the other.
- (iv) Adding the two equations gives the KVL equation from the  $k^{th}$  stage, which is known to be independent of the other mesh equations. Therefore, these two equations must also be independent.
- (b) At Stage 1 we have the single KVL equation around the outer path

$$v_{ab} + v_{bc} + v_{cd} + v_{dh} + v_{hl} + v_{lp} - v_{op} - v_{no} - v_{mn} - v_{im} + v_{ei} - v_{ae} = 0$$

At stage 2 we break this into two smaller loops

$$-v_{ae} + v_{ab} + v_{bc} + v_{cd} + v_{dh} - v_{gh} - v_{fg} - v_{ef} = 0$$

$$v_{ef} + v_{fg} + v_{gh} + v_{hl} + v_{lp} - v_{op} - v_{no} - v_{mn} - v_{im} - v_{ei} = 0$$

At stage 3, we break the latter loop into two smaller ones

$$-v_{ae} + v_{ab} + v_{bc} + v_{cd} + v_{dh} - v_{gh} - v_{fg} - v_{ef} = 0$$

$$-v_{ei} + v_{ef} + v_{fg} + v_{gh} + v_{hl} - v_{kl} - v_{jk} - v_{ij} = 0$$

$$-v_{im} + v_{ij} + v_{jk} + v_{kl} - v_{lp} - v_{op} - v_{no} - v_{mn} = 0$$

Stages 4 through 9 continue the process. The final result is the set of nine independent KVL equations

$$-v_{ae} + v_{ab} + v_{bf} - v_{ef} = 0$$

$$-v_{bf} + v_{bc} + v_{cg} - v_{fg} = 0$$

$$-v_{cg} + v_{cd} + v_{dh} - v_{gh} = 0$$

$$-v_{ei} + v_{ef} + v_{fj} - v_{ij} = 0$$

$$-v_{fj} + v_{fg} + v_{gk} - v_{jk} = 0$$

$$-v_{gk} + v_{gh} + v_{hl} - v_{kl} = 0$$

$$-v_{im} + v_{ij} + v_{jn} - v_{mn} = 0$$

$$-v_{jn} + v_{jk} + v_{ko} - v_{no} = 0$$

$$-v_{ko} + v_{kl} + v_{lp} - v_{op} = 0.$$



**P-1.51 (4)** In Problem P-1.50 a method of proof was outlined for showing that the KVL equations derived from the paths surrounding the meshes in a planar circuit were independent. In this problem we tackle the KCL equations. Prove that the KCL equations written at all but one of the nodes of a circuit are also independent, *i.e.*, that no one of the equations can be derived from the others. As for the KVL equations this can also be proved by induction. Begin with a single enclosing surface that surrounds all of the nodes of the circuit but one and write a single KCL equation for that circuit. Then divide that surface (or one of the eligible surfaces when later there is more than one) into two parts, each of which contains at least one node, and show that the two KCL equations derived from the new surfaces are independent of each other and from the remaining equations. Continue this procedure until the number of surfaces generated is equal to one less than the number of nodes and each surface encloses a single node.

---

**Solution:** As with the previous problem, we proceed by induction. At the first stage we construct an enclosing surface that encloses all of the nodes of the circuit but one. By the general statement of KCL, the sum of all of the currents that cross that surface is equal to zero. At the  $k^{\text{th}}$  stage there are  $k$  encircling surfaces, each of which encircles at least one node. At the  $(k + 1)^{\text{st}}$  stage, one of the enclosing surfaces is split, with at least one node going into each of two daughter surfaces. The procedure terminates when there are  $n - 1$  such surfaces, each of which encircles exactly one node.

At the first stage, there is only one KCL equation. Therefore, it is trivially independent. At the  $k^{\text{th}}$  stage, assume that the KCL equations written for each of the  $k$  encircling surfaces are independent. At the  $(k + 1)^{\text{st}}$  stage, we have the situation depicted in Figure 1.52. The large gray box labelled  $A$  is a surface that encir-

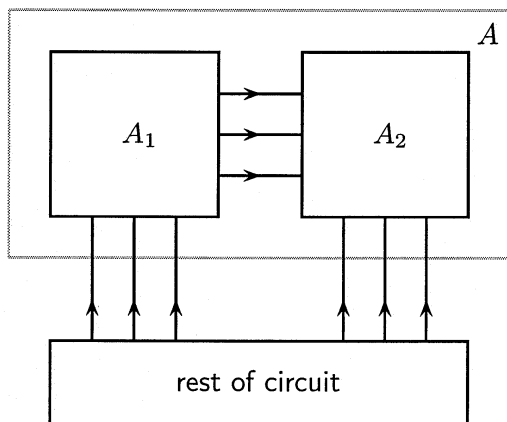

Figure 1.52: Stage  $k + 1$  of the inductive procedure for establishing independence of nodal KCL equations.

cles more than two nodes at stage  $k$ . The other nodes are encircled by the surface labelled “rest of circuit.” At stage  $k + 1$ ,  $A$  is divided into two surfaces,  $A_1$  and  $A_2$ . Let  $S_1$  denote the sum of the currents on the branches that enter  $A_1$  from the “rest of circuit”,  $S_2$  the sum of the currents on the branches that enter  $A_2$  from the “rest of circuit” and  $S_3$  the sum of the currents on the branches that flow from  $A_1$  to  $A_2$ .

From KCL at stage  $k$ , we have

$$S_1 + S_2 = 0.$$

Furthermore this equation cannot be derived from the other KCL equations. Applying KCL to the new surfaces:

$$S_1 + S_3 = 0$$

$$S_2 - S_3 = 0.$$

These two equations are independent of each other, (each has at least one current that the other does not have) and each is independent of the rest of the circuit because of the independence of  $A$ .

**P-1.52 (1,4,5,6)** Consider the circuit in Figure 1.53.

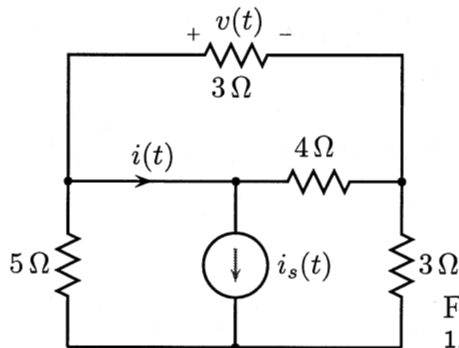

Figure 1.53: Circuit for Problem P-1.52.

- (a) In that circuit, only one voltage and one current have been labelled, since these are the only ones that we eventually want. In order to analyze the circuit, however, we need to assign (explicitly or implicitly) voltages and currents for all of the elements and a voltage drop across the terminals of the current source. On a drawing of the circuit, indicate such a complete set of variables. Adhere to the default sign convention.

- (b) Using your variables in addition to those that are indicated, write the following set of equations: one KVL equation at each mesh, one KCL equation at each node, and one element relation for each resistor.
- (c) Solve your equations for the quantities  $v(t)$  and  $i(t)$ . Since the other element variables are not requested, you should eliminate them first in solving your equations. Notice that you may not need all of the equations that you wrote in part (c). Your answer will be in the form  $v(t) = K_1 i_s(t)$ ,  $i(t) = K_2 i_s(t)$ .

**Solution:**

(a)

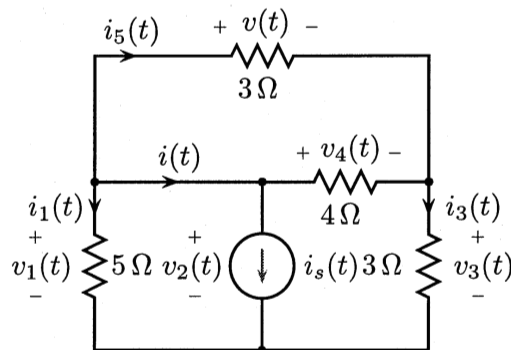

- (b) The two solid dots that are connected by the short circuit bearing the current  $i(t)$  are part of the same node. Nonetheless, it is convenient to treat this as two separate nodes so that the current  $i(t)$  is not lost, since this is a variable of interest. Call the four “nodes”  $a$ ,  $b$ ,  $c$ , and  $d$ .

$$\text{KVL top: } v(t) - v_4(t) = 0$$

$$\text{KVL left: } -v_1(t) + v_2(t) = 0$$

$$\text{KVL right: } -v_2(t) + v_4(t) + v_3(t) = 0$$

$$\text{KCL } a: i_1(t) + i(t) + i_5(t) = 0$$

$$\text{KCL } b: -i(t) + i_s(t) + i_4(t) = 0$$

$$\text{KCL } c: i_3(t) - i_4(t) - i_5(t) = 0$$

$$\text{KCL } d: -i_3(t) - i_s(t) - i_1(t) = 0$$

$$v - i \ 1: v_1(t) = 5i_1(t)$$

$$v - i \ 2: v_3(t) = 3i_3(t)$$

$$v - i \ 3: v_4(t) = 4i_4(t)$$

$$v - i \ 4: v(t) = 3i_5(t)$$

- (c) We will ignore (KCL  $d$ ), since we have written KCL equations at one more node than necessary. We will also add (KVL left)

to (KVL right) to eliminate the variable  $v_2(t)$ , which is not of interest. Then we use the four  $v - i$  relations to eliminate the variables  $v_1(t)$ ,  $v_3(t)$ ,  $v_4(t)$ , and  $i_5(t)$ . At this point the equations look like the following:

$$\begin{aligned}v(t) - 4i_4(t) &= 0 \\-5i_1(t) + 4i_4(t) + 3i_3(t) &= 0 \\i_1(t) + i(t) + \frac{1}{3}v(t) &= 0 \\-i(t) + i_s(t) + i_4(t) &= 0 \\i_3(t) - i_4(t) - \frac{1}{3}v(t) &= 0.\end{aligned}$$

The first of these equations allows us to get rid of  $i_4(t)$ .

$$\begin{aligned}-5i_1(t) + v(t) + 3i_3(t) &= 0 \\i_1(t) + i(t) + \frac{1}{3}v(t) &= 0 \\-i(t) + i_s(t) + \frac{1}{4}v(t) &= 0 \\i_3(t) - \frac{7}{12}v(t) &= 0.\end{aligned}$$

The last equation allows us to get rid of  $i_3(t)$ .

$$\begin{aligned}-5i_1(t) + \frac{11}{4}v(t) &= 0 \\i_1(t) + i(t) + \frac{1}{3}v(t) &= 0 \\-i(t) + i_s(t) + \frac{1}{4}v(t) &= 0.\end{aligned}$$

Now, we can use the top equation to get rid of  $i_1(t)$ .

$$\begin{aligned}i(t) + \frac{53}{60}v(t) &= 0 \\-i(t) + \frac{1}{4}v(t) &= -i_s(t).\end{aligned}$$

Solving these two equations in two unknowns gives the solution

$$\begin{aligned}v(t) &= -\frac{15}{17}i_s(t) \\i(t) &= \frac{53}{68}i_s(t).\end{aligned}$$

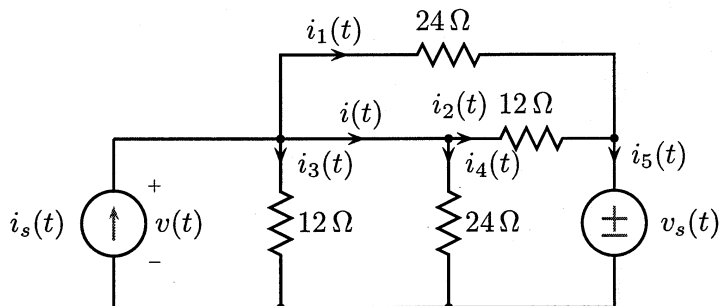

Figure 1.54: Circuit for Problem P 1.53.

**P-1.53 (4,5,6)** Determine  $v(t)$  and  $i(t)$  in the network shown in Figure 1.54

**Solution:** The two variables of interest,  $v(t)$  and  $i(t)$ , can readily be expressed in terms of the element variables as

$$\begin{aligned}v(t) &= v_3(t) \\ i(t) &= i_2(t) + i_4(t).\end{aligned}$$

Therefore, it will be sufficient to solve for the resistor voltages and currents. If there are eight variables, we must have eight independent equations. We can get four of these from the element relations for the resistors

$$\begin{aligned}v_1(t) &= 24i_1(t) \\ v_2(t) &= 12i_2(t) \\ v_3(t) &= 12i_3(t) \\ v_4(t) &= 24i_4(t),\end{aligned}$$

one from KCL at the large node at the upper left

$$i_1(t) + i_2(t) + i_3(t) + i_4(t) = i_s(t),$$

and three from KVL equations (ignoring the mesh with the current source)

$$\begin{aligned}v_1(t) - v_2(t) &= 0 \\ v_3(t) - v_4(t) &= 0 \\ -v_2(t) + v_4(t) &= v_s(t).\end{aligned}$$

The four element relations will allow us to express the resistor voltages in terms of their currents. Furthermore, the first two KVL equations allow us to eliminate two of the currents since

$$\begin{aligned}v_1(t) = v_2(t) &\implies 2i_1(t) = i_2(t) \\ v_3(t) = v_4(t) &\implies 2i_4(t) = i_3(t).\end{aligned}$$

Thus the KCL equation reduces to

$$i_1(t) + i_4(t) = \frac{1}{3}i_s(t)$$

and the remaining KVL equation becomes

$$-i_1(t) + i_4(t) = \frac{1}{24}v_s(t).$$

These final equations are straightforward to solve. Adding the two equations gives

$$i_4(t) = \frac{1}{6}i_s(t) + \frac{1}{48}v_s(t).$$

Substituting this result into the first of these equations gives

$$i_1(t) = \frac{1}{6}i_s(t) - \frac{1}{48}v_s(t).$$

Since  $2i_4(t) = i_3(t)$ , we have

$$v(t) = v_3(t) = 24i_4(t) = 4i_s(t) + \frac{1}{2}v_s(t)$$

and

$$i(t) = i_2(t) + i_4(t) = 2i_1(t) + i_4(t) = \frac{1}{2}i_s(t) - \frac{1}{48}v_s(t).$$

**P-1.54 (4,5,6)** The circuit in Figure 1.55 contains a two-terminal nonlinear element  $N$  that satisfies the  $v - i$  relation

$$v(t) = \begin{cases} 9 - i^2(t), & 0 \leq i(t) \leq 9 \\ 0, & \text{otherwise.} \end{cases}$$

Determine two possible equilibrium values for the current,  $i(t)$ . *Note:* Although you have not yet seen any examples involving nonlinear elements, Kirchhoff's Laws still apply to the circuit and Ohm's Law still applies to the resistor.

**Solution:** We can begin by writing a KVL equation around the closed path:

$$-7 + i(t) + v(t) = 0. \quad (1.8)$$

If a solution lies in the range  $0 \leq i(t) \leq 3$ , then after substituting the appropriate relation for the  $v - i$  relation, (1.8) becomes

$$-7 + i(t) + 9 - i^2(t) = 0 \implies i^2(t) - i(t) - 2 = 0.$$

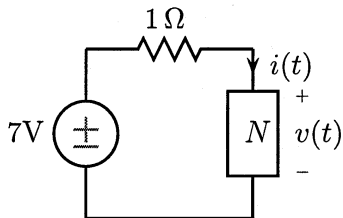

Figure 1.55: Circuit containing a nonlinear element for Problem P-1.54.

for  $0 \leq i(t) \leq 3$ . This quadratic equation has two solutions:  $i(t) = 2$  and  $i(t) = -1$ , but only the former lies in the required range.

For other values of  $i(t)$ , (1.8) becomes

$$-7 + i(t) + 0 = 0,$$

whose solution is  $i(t) = 7$ . Thus, the two equilibrium solutions are  $i(t) = 2$  and  $i(t) = 7$ .

**P-1.55 (4,5,6)** In the center of Figure 1.56 is a model of a one-transistor preamplifier that is used to amplify the output of a low amplitude magnetic pickup, and drive a  $25 \text{ k}\Omega$  load. Express the voltage  $v_L(t)$  measured across the load in terms of  $v_s(t)$ .

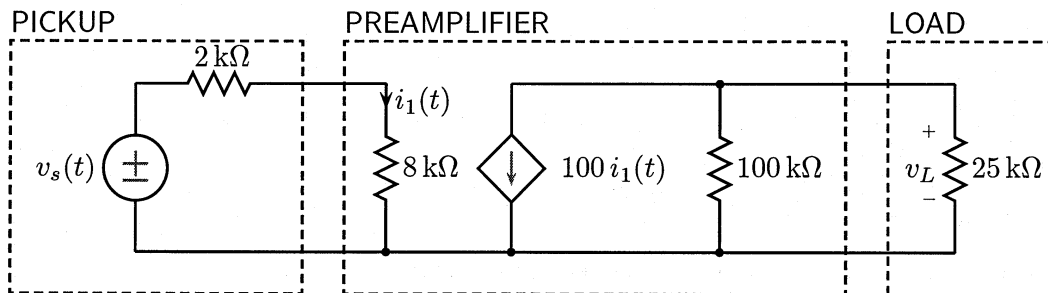

Figure 1.56: Circuit for Problem P-1.55.

**Solution:** We begin by writing a KVL equation around the left mesh. This will allow us to solve for  $i_1(t)$  in terms of  $v_s(t)$ :

$$v_s(t) = 2000i_1(t) + 8000i_1(t)$$

or

$$i_1(t) = \frac{1}{10,000}v_s(t).$$

The voltage across the  $100\text{ k}\Omega$  resistor is  $v_L(t)$ . Writing a KCL equation at the node connected to the  $+$  terminal of the load gives

$$\frac{1}{25,000}v_L(t) + \frac{1}{100,000}v_L(t) = -100i_1(t).$$

From this we deduce

$$v_L(t) = -2,000,000 i_1(t) = -200 v_s(t).$$

**P-1.56 (2,5)** Two resistors connected in series act like a single resistor. Similarly, two resistors connected in parallel behave like a single resistor. In this problem, we derive these basic results.

- (a) Consider two resistors connected in series and connected across a voltage source, as in Figure 1.57a. Show that the current flowing through them is proportional to the source voltage.

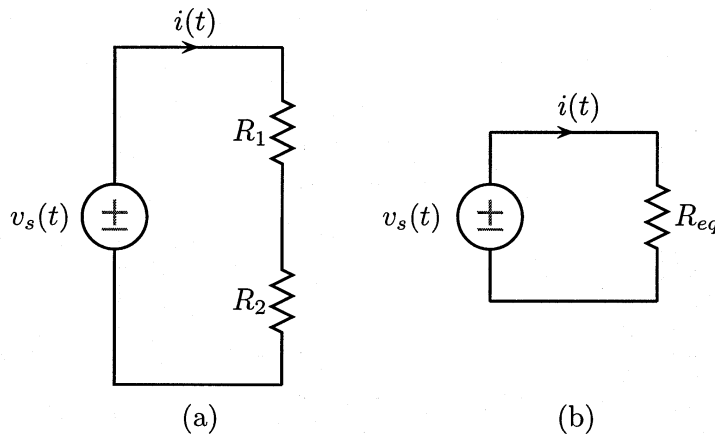

Figure 1.57: Two resistors connected in series and their equivalent resistance.

- (b) This implies that from the point-of-view of the voltage source, the series connection of resistors is equivalent to a single resistor as shown in Figure 1.57b. Express  $R_{eq}$  in terms of  $R_1$  and  $R_2$ .
- (c) We can similarly consider two resistors connected in parallel across a voltage source, as in Figure 1.58a. Show again that the current flowing through them is proportional to the source voltage.
- (d) Find the equivalent resistance of the parallel combination as you did in part (b).



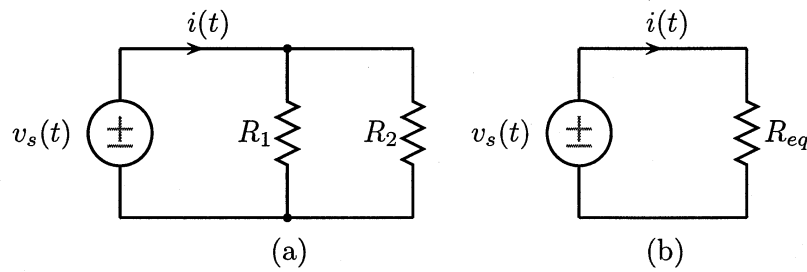

Figure 1.58: Two resistors connected in parallel and their equivalent resistance.

---

**Solution:**

(a) From KVL

$$\begin{aligned} v_s(t) &= v_1(t) + v_2(t) \\ &= R_1 i(t) + R_2 i(t) \\ &= (R_1 + R_2) i(t). \end{aligned}$$

or

$$i(t) = \frac{1}{R_1 + R_2} v_s(t).$$

(b) From the equivalent circuit

$$i(t) = \frac{1}{R_{eq}} v_s(t).$$

Therefore,

$$R_{eq} = R_1 + R_2$$

(c) From KCL

$$\begin{aligned} i(t) &= i_1(t) + i_2(t) \\ &= \frac{v_s(t)}{R_1} + \frac{v_s(t)}{R_2} = \left( \frac{1}{R_1} + \frac{1}{R_2} \right) v_s(t). \end{aligned}$$

(d)

$$\frac{1}{R_{eq}} = \frac{1}{R_1} + \frac{1}{R_2}$$

or

$$R_{eq} = \frac{1}{\frac{1}{R_1} + \frac{1}{R_2}} = \frac{R_1 R_2}{R_1 + R_2}$$

---

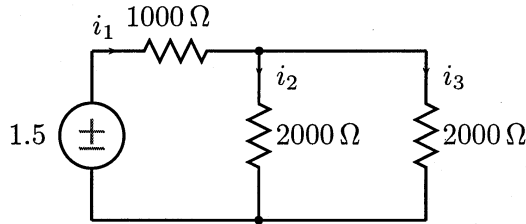

Figure 1.59: Circuit for Problem P-1.57.

**P-1.57 (3,4,5,6)** Consider the circuit shown in Figure 1.59.

- This circuit contains three elements and thus there are six element variables, all of which are constant since the voltage source is constant. The currents are labelled and the voltages across the terminals of the three resistors are implied by the default sign convention. Write a set of six linear equations in the variables  $v_1$ ,  $v_2$ ,  $v_3$ ,  $i_1$ ,  $i_2$ , and  $i_3$  that specify the complete solution. These should take the form of three element relations, one KCL equation, and two KVL equations.
- Solve the above set of equations to determine the values of the element variables.
- Evaluate the power absorbed by all of the elements and sources. Show that the total power absorbed in the resistors is equal to the total power supplied by the source.

The net power in any circuit must always be zero, i.e. the total power absorbed must always equal the total power supplied. This problem demonstrates that fact for one particular circuit. We will prove the general case later.

---

**Solution:**

(a)

$$R_1 : \quad v_1 = 1000i_1$$

$$R_2 : \quad v_2 = 2000i_2$$

$$R_3 : \quad v_3 = 2000i_3$$

$$KCL : \quad i_1 - i_2 - i_3 = 0$$

$$KVL_1 : \quad v_1 + v_2 = 1.5$$

$$KVL_2 : \quad -v_2 + v_3 = 0$$

- (b) The solution of these six equations in six unknowns is straightforward. The solution is:

$$v_1 = 0.75V \quad i_1 = 0.75mA$$

$$v_2 = 0.75V \quad i_2 = 0.375mA$$

$$v_3 = 0.75V \quad i_3 = 0.375mA$$

(c)

$$P_1 = (0.75V)(0.75mA) = 0.5625mW$$

$$P_2 = (0.75V)(0.375mA) = 0.28125mW$$

$$P_3 = (0.75V)(0.375mA) = 0.28125mW$$

Therefore, the total power absorbed is:

$$P_d = P_1 + P_2 + P_3 = 1.125mW.$$

The total power supplied by the battery is

$$P_s = (1.5V)(0.75mA) = 1.125mW.$$

**P-1.58 (2,4,5)** Find the differential equation that relates the current  $i(t)$  to the source voltage  $v_s(t)$  in the circuit of Figure 1.60.

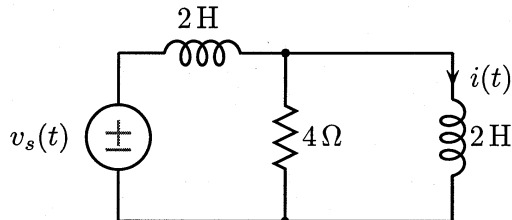

Figure 1.60: Circuit for Problem P-1.58.

**Solution:** Let the current through the horizontal inductor be  $i_1(t)$ . Then from KCL the resistor current is  $i_1(t) - i(t)$ . Using these currents, we can write KVL equations on the two meshes.

$$2 \frac{di_1(t)}{dt} + 4(i_1(t) - i(t)) = v_s(t)$$

$$4(i(t) - i_1(t)) + 2 \frac{di(t)}{dt} = 0$$

From the second equation

$$i_1(t) = \frac{1}{2} \frac{di(t)}{dt} + i(t).$$

If we substitute this result into the first equation we get

$$\frac{d^2 i(t)}{dt^2} + 2 \frac{di(t)}{dt} + 2 \frac{di(t)}{dt} + 4i(t) - 4i(t) = v_s(t),$$

which simplifies to

$$\frac{d^2 i(t)}{dt^2} + 4 \frac{di(t)}{dt} = v_s(t).$$

---

## Design Problems

**P-1.59 (3)** Determine the minimum and maximum values of the resistance  $R$  in the circuit of Figure 1.61 such that the following two conditions will be met:

- (i)  $i \geq 25 \text{ mA}$
- (ii)  $P_{inst} \leq 500 \text{ mW}$ ,

where  $P_{inst}$  is the instantaneous power absorbed by the resistor.

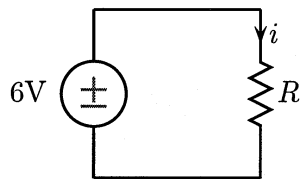

Figure 1.61: Circuit for Problem P-1.59.

---

**Solution:** Computing the current and applying its bound gives

$$i = \frac{6 \text{ V}}{R} \geq 0.025 \text{ A} \implies R \leq \frac{6 \text{ V}}{0.025 \text{ A}} = 240 \Omega.$$

The constraint on the instantaneous power gives

$$P_{inst} = \frac{(6 \text{ V})^2}{R} \leq 0.5 \text{ W} \implies R \geq \frac{36}{0.5} = 72 \Omega.$$

Therefore,

$$72 \Omega \leq R \leq 240 \Omega$$

---

**P-1.60 (3,4,5,6)**

- (a) Determine the voltage  $v$  in the circuit in Figure 1.62 as a function of the resistance  $R$ .
- (b) Determine the maximum and minimum values of  $R$  such that both of the following conditions will be true:
- $v \geq 10$  V.
  - $P_{inst} \geq 5$  W.

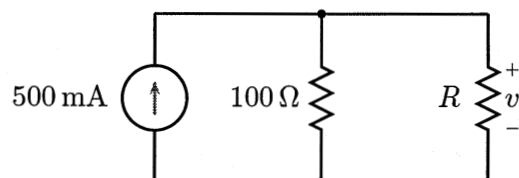

Figure 1.62: Circuit for Problem P-1.60.

**Solution:**

- (a) Let the voltage across both resistors be  $v$ . Then, from KCL

$$\begin{aligned}\frac{v}{R} + \frac{v}{100} &= 500 \text{ mA} \\ v(100 + R) &= 50R \\ v &= \frac{50R}{100 + R}\end{aligned}$$

- (b) The requirement that  $v \geq 10$  implies

$$\frac{50R}{100 + R} \geq 10$$

or

$$50R \geq 1000 + 10R \implies 40R \geq 1000 \implies R \geq 25.$$

The instantaneous power absorbed by the resistor is

$$P_{inst} = \left( \frac{50R}{100 + R} \right)^2 \cdot \frac{1}{R} = \frac{2500R}{(100 + R)^2}$$

Thus, we must also have

$$\frac{2500R}{(100 + R)^2} \geq 5.$$

This is equivalent to the polynomial constraint

$$R^2 - 300R + 10,000 \leq 0$$

The polynomial on the left side has roots at  $R = 38.2$  and  $R = 261.8$ . It is negative if  $38.2 \leq R \leq 261.8$ . For the voltage and power inequalities to both be true, we must have  $238.2 \leq R \leq 261.8$ .

**P-1.61 (2,3)** Resistors are specified by their maximum power rating as well as by their resistance. For example, a resistor with a power rating of 1 W can absorb 1W of power indefinitely. The larger the power rating, the bulkier and more expensive the resistor, so good design practice dictates that the power ratings should be large enough to handle the load, but no larger than necessary. If the resistors in the circuit in Figure 1.63 are available in power ratings of 1 W, 1/2 W, 1/4 W, and 1/10 W, specify the power ratings needed.

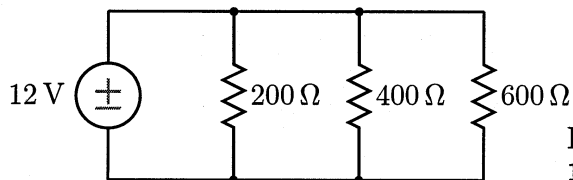

Figure 1.63: Circuit for Problem P-1.61.

**Solution:** The power absorbed by a resistor with a voltage drop of  $V$  and a resistance of  $R$  is

$$P_{inst} = \frac{V^2}{R}$$

For  $V = 12$  and  $R = 200, 400, 600$  we have

$$P_{inst} = \frac{144}{200} = 0.72$$

$$P_{inst} = \frac{144}{400} = 0.36$$

$$P_{inst} = \frac{144}{600} = 0.24.$$

Therefore, we should use a 200Ω resistor with a 1 W power rating, a 400Ω resistor with a 1/2 W power rating, and a 600Ω resistor with a 1/4 W power rating.