

CHAPTER 2

Discrete-Time Signals and Systems

Tutorial Problems

1. (a) MATLAB script:

```
% P0201a: Generate and plot unit sample
close all; clc
n = -20:40; % specify support of signal
deltan = zeros(1,length(n)); % define signal
deltan(n==0)=1;
% Plot:
hf = figconf('P0201a','small');
stem(n,deltan,'fill')
axis([min(n)-1,max(n)+1,min(deltan)-0.2,max(deltan)+0.2])
xlabel('n','fontsize',LFS); ylabel('\delta[n]','fontsize',LFS);
title('Unit Sample \delta[n]','fontsize',TFS)
```

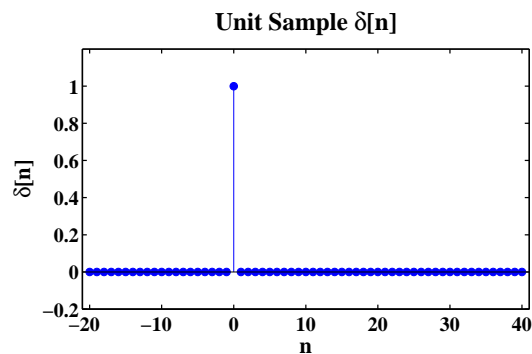
FIGURE 2.1: unit sample $\delta[n]$.

(b) MATLAB script:

```
% P0201b: Generate and plot unit step sequence
close all; clc
n = -20:40; % specify support of signal
un = zeros(1,length(n)); % define signal
un(n>=0)=1;
% Plot:
hf = figconfg('P0201b','small');
stem(n,un,'fill')
axis([min(n)-1,max(n)+1,min(un)-0.2,max(un)+0.2])
xlabel('n','fontsize',LFS); ylabel('u[n]','fontsize',LFS);
title('Unit Step u[n]','fontsize',TFS)
```

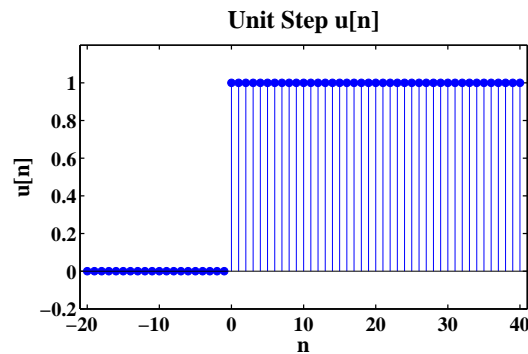
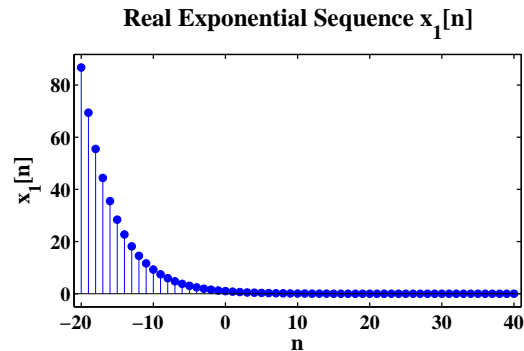

FIGURE 2.2: unit step $u[n]$.

(c) MATLAB script:

```
% P0201c: Generate and plot real exponential sequence
close all; clc
n = -20:40; % specify support of signal
x1n = 0.8.^n; % define signal
% Plot:
hf = figconfg('P0201c','small');
stem(n,x1n,'fill')
axis([min(n)-1,max(n)+1,min(x1n)-5,max(x1n)+5])
xlabel('n','fontsize',LFS); ylabel('x_1[n]','fontsize',LFS);
title('Real Exponential Sequence x_1[n]','fontsize',TFS)
```

(d) MATLAB script:

FIGURE 2.3: real exponential signal $x_1[n] = (0.80)^n$.

```

% P0201d: Generate and plot complex exponential sequence
close all; clc
n = -20:40; % specify support of signal
x2n = (0.9*exp(j*pi/10)).^n; % define signal
x2n_r = real(x2n); % real part
x2n_i = imag(x2n); % imaginary part
x2n_m = abs(x2n); % magnitude part
x2n_p = angle(x2n); % phase part
% Plot:
hf = figconfg('P0201d');
subplot(2,2,1)
stem(n,x2n_r,'fill')
axis([min(n)-1,max(n)+1,min(x2n_r)-1,max(x2n_r)+1])
xlabel('n','fontsize',LFS); ylabel('Re\{x_2[n]\}','fontsize',LFS);
title('Real Part of Sequence x_2[n]','fontsize',TFS)
subplot(2,2,2)
stem(n,x2n_i,'fill')
axis([min(n)-1,max(n)+1,min(x2n_i)-1,max(x2n_i)+1])
xlabel('n','fontsize',LFS); ylabel('Im\{x_2[n]\}','fontsize',LFS);
title('Imaginary Part of Sequence x_2[n]','fontsize',TFS)
subplot(2,2,3)
stem(n,x2n_m,'fill')
axis([min(n)-1,max(n)+1,min(x2n_m)-1,max(x2n_m)+1])
xlabel('n','fontsize',LFS); ylabel('|x_2[n]|','fontsize',LFS);
title('Magnitude of Sequence x_2[n]','fontsize',TFS)
subplot(2,2,4)

```

```

stem(n,x2n_p,'fill')
axis([min(n)-1,max(n)+1,min(x2n_p)-1,max(x2n_p)+1])
xlabel('n','fontsize',LFS); ylabel('\phi(x_2[n])','fontsize',LFS);
title('Phase of Sequence x_2[n]','fontsize',TFS)

```

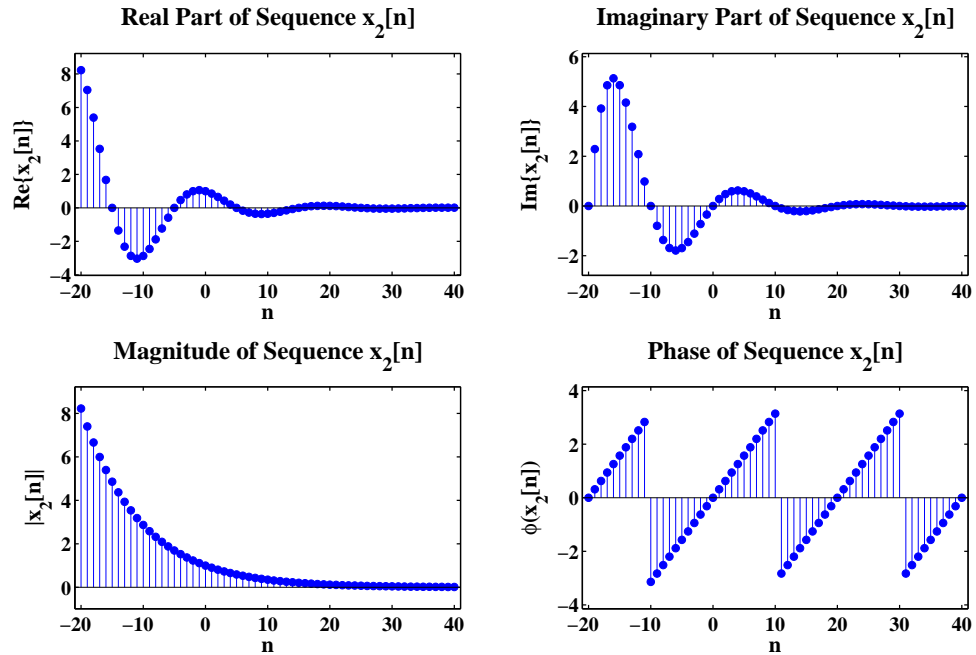

FIGURE 2.4: complex exponential signal $x_2[n] = (0.9e^{j\pi/10})^n$.

(e) MATLAB script:

```

% P0201e: Generate and plot real sinusoidal sequence
close all; clc
n = -20:40; % specify support of signal
x3n = 2*cos(2*pi*0.3*n+pi/3); % define signal
% Plot:
hf = figconf('P0201e','small');
stem(n,x3n,'fill')
axis([min(n)-1,max(n)+1,min(x3n)-0.5,max(x3n)+0.5])
xlabel('n','fontsize',LFS); ylabel('x_3[n]','fontsize',LFS);
title('Real Sinusoidal Sequence x_3[n]','fontsize',TFS)

```

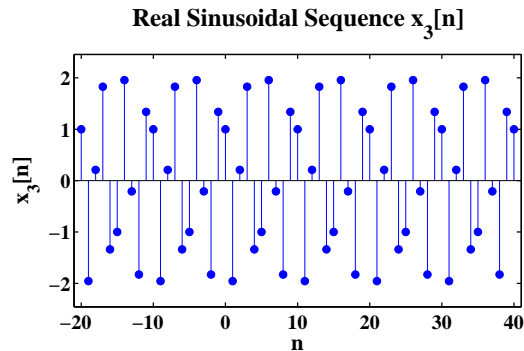

FIGURE 2.5: sinusoidal sequence $x_3[n] = 2 \cos[2\pi(0.3)n + \pi/3]$.

2. MATLAB script:

```
% P0202: Illustrate the noncommutativity of folding and shifting
close all; clc
nx = 0:4; % specify the support
x = 5:-1:1; % specify sequence
n0 = 2;
% (a) First folding, then shifting
[y1 ny1] = fold(x,nx);
[y1 ny1] = shift(y1,ny1,-n0);
% (b) First shifting, then folding
[y2 ny2] = shift(x,nx,-n0);
[y2 ny2] = fold(y2,ny2);
% Plot
hf = figconf('P0202');
xylim = [min([nx(1),ny1(1),ny2(1)])-1,max([nx(end),ny1(end)...
    ,ny2(end)])+1,min(x)-1,max(x)+1];
subplot(3,1,1)
stem(nx,x,'fill')
axis(xylim)
ylabel('x[n]','fontsize',LFS); title('x[n]','fontsize',TFS);
set(gca,'Xtick',xylim(1):xylim(2))
subplot(3,1,2)
stem(ny1,y1,'fill')
axis(xylim)
ylabel('y_1[n]','fontsize',LFS);
```

```

title('y_1[n]: Folding and Shifting','fontsize',TFS)
set(gca,'Xtick',xylim(1):xylim(2))
subplot(3,1,3)
stem(ny2,y2,'fill')
axis(xylim)
xlabel('n','fontsize',LFS); ylabel('y_2[n]','fontsize',LFS);
title('y_2[n]: Shifting and Folding','fontsize',TFS)
set(gca,'Xtick',xylim(1):xylim(2))

```

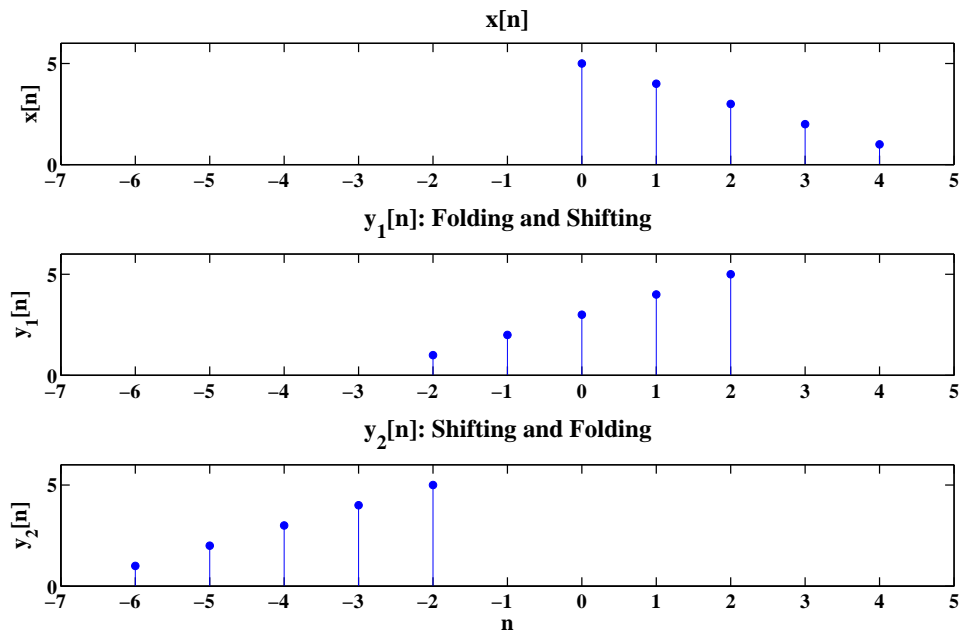

FIGURE 2.6: Illustrating noncommutativity of folding and shifting operations.

Comments:

From the plot, we can see $y_1[n]$ and $y_2[n]$ are different. Indeed, $y_1[n]$ represents the correct $x[2-n]$ signal while $y_2[n]$ represents signal $x[-n-2]$.

3. (a) $x[-n] = \{4, 4, 4, 4, \underset{\uparrow}{4}, 3, 2, 1, 0, -1\}$
 $x[n-3] = \{-1, 0, \underset{\uparrow}{1}, 2, 3, 4, 4, 4, 4, 4\}$
 $x[n+2] = \{-1, 0, 1, 2, 3, 4, 4, \underset{\uparrow}{4}, 4, 4\}$

(b) see part (c)

(c) MATLAB script:

```
% P0203bc: Illustrate the folding and shifting effect
close all; clc
nx = -5:4; % specify support
x = [-1:4,4*ones(1,4)]; % define sequence
[y1 ny1] = fold(x,nx); % folding
[y2 ny2] = shift(x,nx,-3); % right-shifting
[y3 ny3] = shift(x,nx,2); % left-shifting
% Plot
hf = figconfg('P0203');
xylim = [min([nx(1),ny1(1),ny2(1),ny3(1)])-1,max([nx(end),...
    ny1(end),ny2(end),ny3(end)])+1,min(x)-1,max(x)+1];
subplot(4,1,1)
stem(nx,x,'fill'); axis(xylim)
ylabel('x[n]', 'fontsize',LFS); title('x[n]', 'fontsize',TFS);
set(gca,'Xtick',xylim(1):xylim(2))
subplot(4,1,2)
stem(ny1,y1,'fill'); axis(xylim)
ylabel('x[-n]', 'fontsize',LFS); title('x[-n]', 'fontsize',TFS)
set(gca,'Xtick',xylim(1):xylim(2))
subplot(4,1,3)
stem(ny2,y2,'fill'); axis(xylim)
ylabel('x[n-3]', 'fontsize',LFS); title('x[n-3]', 'fontsize',TFS);
set(gca,'Xtick',xylim(1):xylim(2))
subplot(4,1,4)
stem(ny3,y3,'fill'); axis(xylim)
xlabel('n', 'fontsize',LFS); ylabel('x[n+2]', 'fontsize',LFS);
title('x[n+2]', 'fontsize',TFS)
set(gca,'Xtick',xylim(1):xylim(2))
```

4. MATLAB script:

```
% P0204: Illustrate the using of repmat, perseggen and pulstran
%           to generate periodic signal
close all; clc
n = 0:9; % specify support
x = [ones(1,4),zeros(1,6)]; % sequence 1
% x = cos(0.1*pi*n); % sequence 2
```

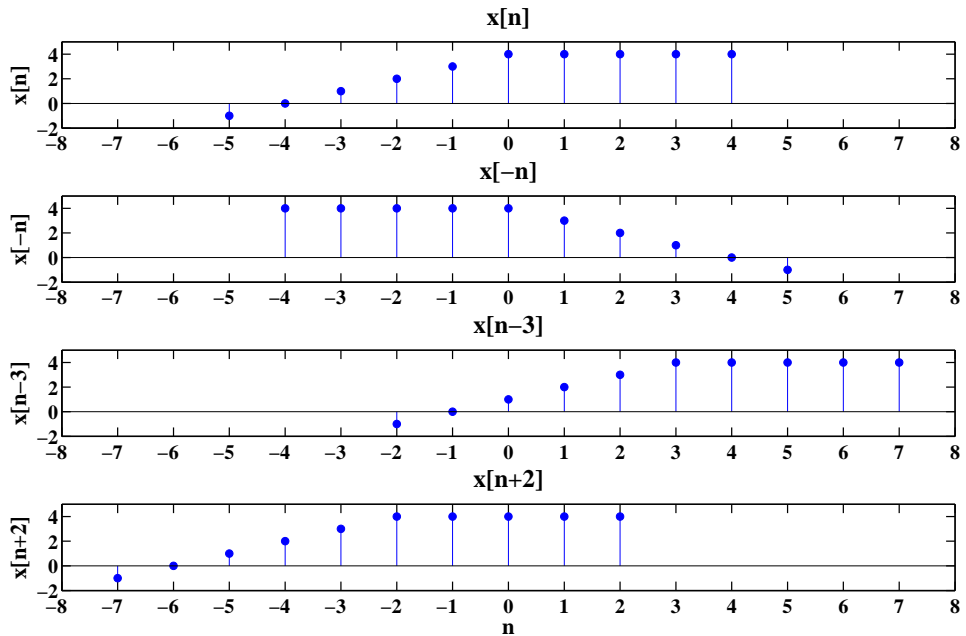

FIGURE 2.7: Illustrating folding and shifting operations.

```

% x = 0.8.^n; % sequence 3
Np = 5; % number of periods
xp1 = repmat(x,1,Np);
nxp1 = n(1):Np*length(x)-1;
[xp2 nxp2] = perseggen(x,length(x),Np*length(x),n(1));
xp3 = pulstran(nxp1,(0:Np-1)*length(x),x);
%Plot
hf = figconf('P0204');
xylim = [-1,nxp1(end)+1,min(x)-1,max(x)+1];
subplot(3,1,1)
stem(nxp1,xp1,'fill'); axis(xylim)
ylabel('x_p[n]', 'fontsize',LFS);
title('Function ''repmat''', 'fontsize',TFS);
subplot(3,1,2)
stem(nxp2,xp2,'fill'); axis(xylim)
ylabel('x_p[n]', 'fontsize',LFS);

```



```

title('Function ''perseggen''','fontsize',TFS)
subplot(3,1,3)
stem(nxp1,xp3,'fill'); axis(xylim)
xlabel('n','fontsize',LFS); ylabel('x_p[n]','fontsize',LFS);
title('Function ''pulstran''','fontsize',TFS)

```

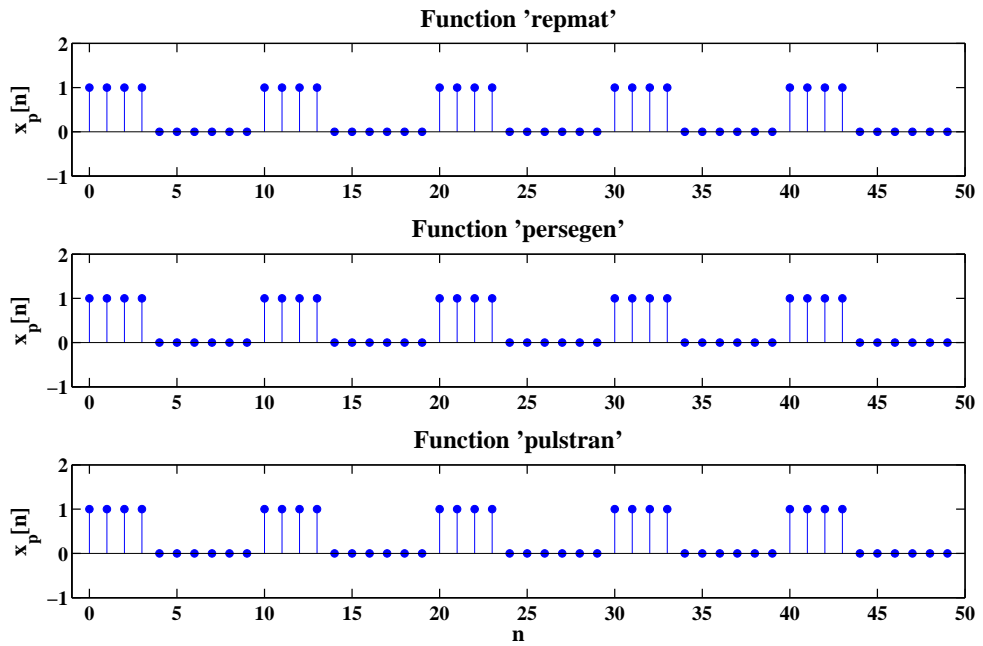

FIGURE 2.8: Periodically expanding sequence $\{1, 1, 1, 1, 0, 0, 0, 0, 0, 0, 0, 0\}$.

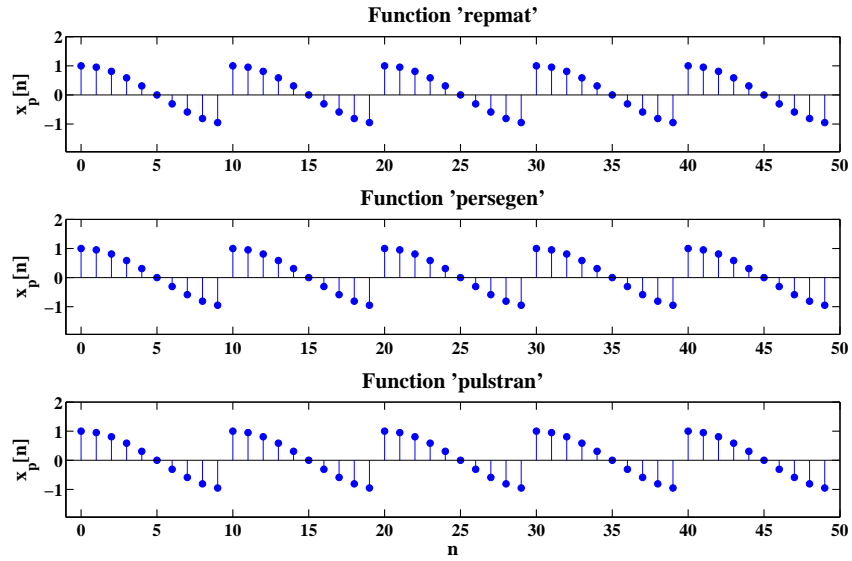

FIGURE 2.9: Periodically expanding sequence $\cos(0.1\pi n)$, $0 \leq n \leq 9$.

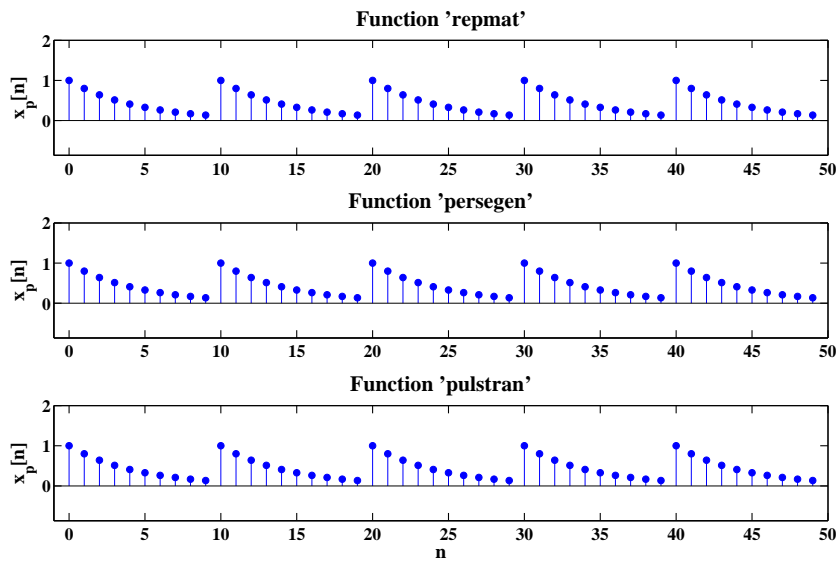

FIGURE 2.10: Periodically expanding sequence 0.8^n , $0 \leq n \leq 9$.

5. (a) Proof: If the sinusoidal signal $\cos(\omega_0 n + \theta_0)$ is periodic in n , we need to find a period N_p that satisfy $\cos(\omega_0 n + \theta_0) = \cos(\omega_0 n + \omega_0 N_p + \theta_0)$ for every n . Since $f_0 \triangleq \frac{\omega_0}{2\pi}$ is a rational number, we can substitute $\omega_0 = 2\pi f_0 = 2\pi \frac{M}{N}$ into the previous periodic condition to have $\cos(2\pi \frac{M}{N} n + \theta_0) = \cos(2\pi \frac{M}{N} n + 2\pi \frac{M}{N} N_p + \theta_0)$. No matter what integers M and N take, $N_p = N$ is a period of the sinusoidal signal.
- (b) The sequence is NOT periodic.
- (c) The sequence is periodic with fundamental period $N = 10$. N can be interpreted as period and M is the number of repetitions the corresponding continuous signal repeats itself.

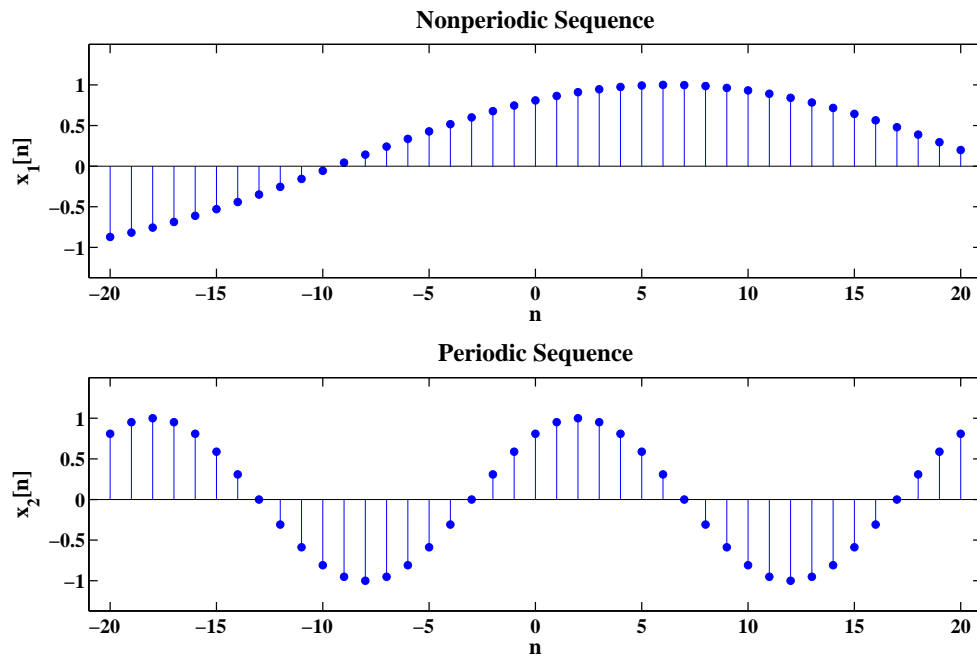

FIGURE 2.11: Illustrating the periodicity condition of sinusoidal signals.

MATLAB script:

```
% P0205: Illustrates the condition for periodicity of discrete
%          sinusoidal sequence
close all; clc
% Part (b): Nonperiodic
```

```

n = -20:20; % support
w1 = 0.1; % angular frequency
x1 = cos(w1*n-pi/5);
% Part (c): Periodic
w2 = 0.1*pi; % angular frequency
x2 = cos(w2*n-pi/5);
%Plot
hf = figconfg('P0205');
xylim = [n(1)-1,n(end)+1,min(x1)-0.5,max(x1)+0.5];
subplot(2,1,1)
stem(n,x1,'fill'); axis(xylim)
xlabel('n','fontsize',LFS); ylabel('x_1[n]','fontsize',LFS);
title('Nonperiodic Sequence','fontsize',TFS);
% set(gca,'Xtick',xylim(1):xylim(2))
subplot(2,1,2)
stem(n,x2,'fill'); axis(xylim)
xlabel('n','fontsize',LFS); ylabel('x_2[n]','fontsize',LFS);
title('Periodic Sequence','fontsize',TFS)

```

6. MATLAB script:

```

% P0206: Investigates the effect of downsampling using
%         audio file 'handel'
close all; clc
load('handel.mat')
n = 1:length(y);
% Part (a): original sampling rate
sound(y,Fs); pause(1)
% Part (b): downsampling by a factor of two
y_ds2_ind = mod(n,2)==1;
sound(y(y_ds2_ind),Fs/2); pause(1)
% Part (c): downsampling by a factor of four
y_ds4_ind = mod(n,4)==1;
sound(y(y_ds4_ind),Fs/4)
% save the sound file
wavwrite(y(y_ds4_ind),Fs/4,'handel_ds4')

```

7. Comments: The first system is NOT time-invariant but the second system is time invariant.

MATLAB script:

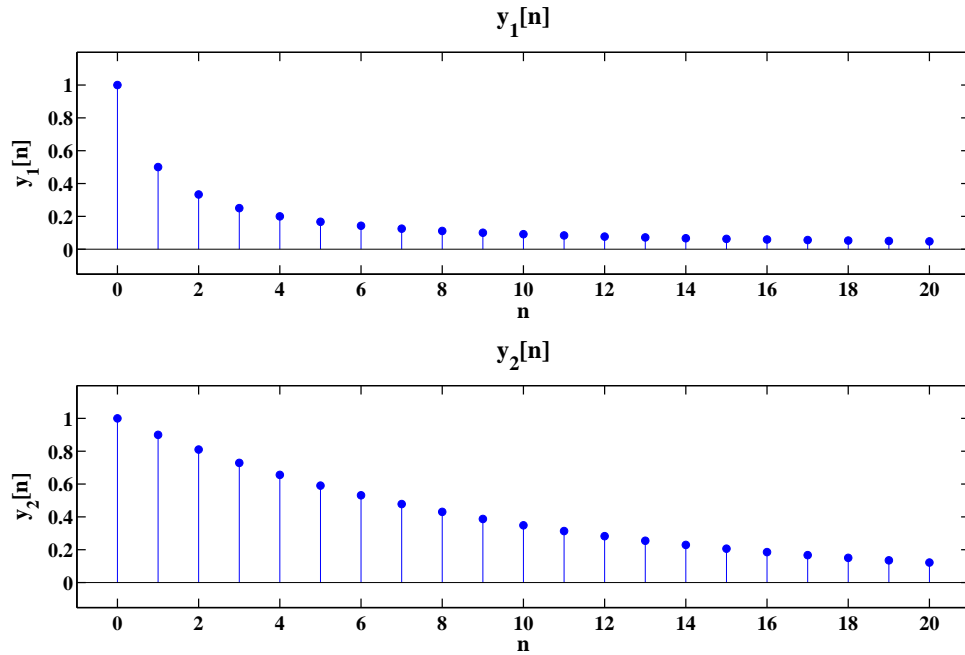
FIGURE 2.12: System responses with respect to input signal $x[n] = \delta[n]$.

```

% P0207: Compute and plot sequence defined by difference equations
close all; clc
n = 0:20; % define support
yi = 0; % zero initial condition
xn = delta(n(1),0,n(end))'; % input 1
% xn = delta(n(1),5,n(end))'; % input 2
% Compute sequence 1:
yn1 = zeros(1,length(n));
yn1(1) = n(1)/(n(1)+1)*yi+xn(1);
for ii = 2:length(n)
    yn1(ii) = n(ii)/(n(ii)+1)*yn1(ii-1)+xn(ii);
end
% Compute sequence 2:
yn2 = filter(1,[1,-0.9],xn);
%Plot
hf = figconfg('P0207');

```

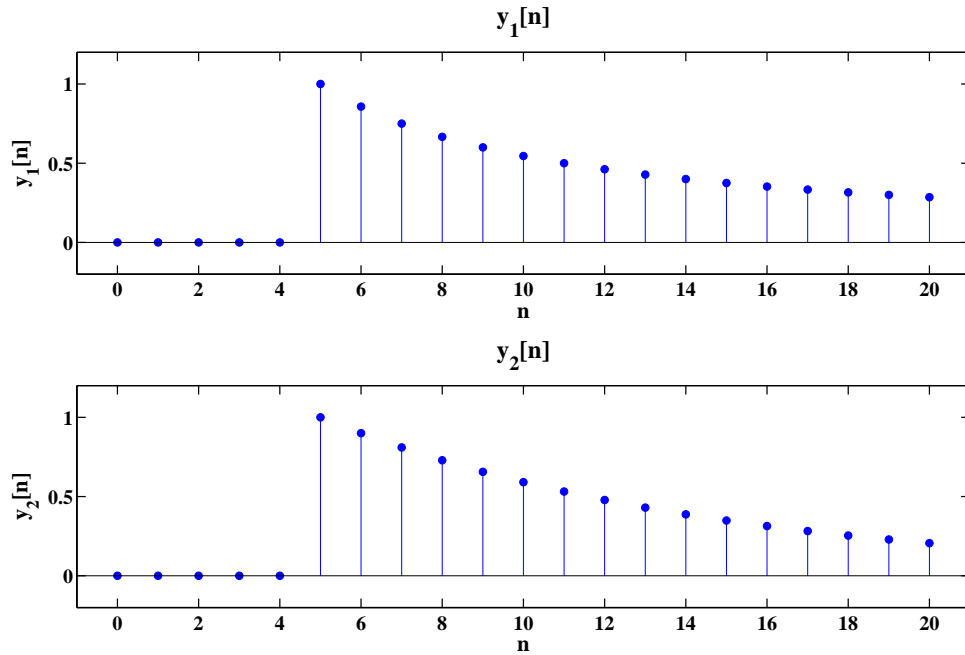
FIGURE 2.13: System responses with respect to input signal $x[n] = \delta[n - 5]$.

```

xylim = [n(1)-1,n(end)+1,min(yn1)-0.2,max(yn1)+0.2];
subplot(2,1,1)
stem(n,yn1,'fill'); axis(xylim)
xlabel('n','fontsize',LFS); ylabel('y_1[n]','fontsize',LFS);
title('y_1[n]','fontsize',TFS);
subplot(2,1,2)
stem(n,yn2,'fill'); axis(xylim)
xlabel('n','fontsize',LFS); ylabel('y_2[n]','fontsize',LFS);
title('y_2[n]','fontsize',TFS)

```

8. (a)

$$y[n] = \frac{1}{5} (x[n] + x[n-1] + x[n-2] + x[n-3] + x[n-4])$$

(b)

$$h[n] = u[n] - u[n-5]$$

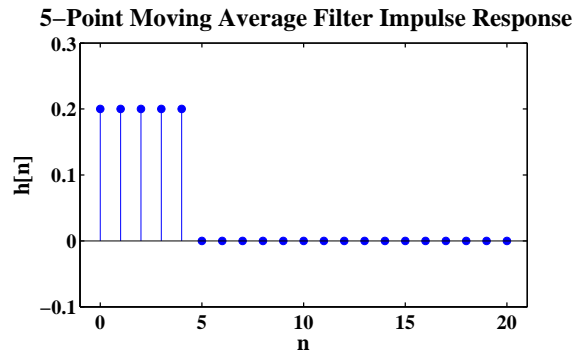

FIGURE 2.14: Impulse response of a 5-point moving average filter.

(c) Block diagram.

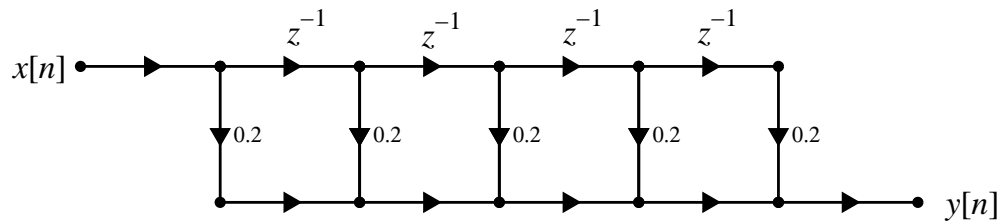

FIGURE 2.15: Block diagram of a 5-point moving average filter.

MATLAB script:

```
% P0208: Plot the 5-point moving average filter
%      y[n] = 1/5*(x[n]+x[n-1]+x[n-2]+x[n-3]+x[n-4]);
close all; clc
n = 0:20;
xn = delta(n(1),0,n(end))';
hn = filter(ones(1,5)/5,1,xn);
%Plot
hf = figconf('P0208','small');
xylim = [n(1)-1,n(end)+1,min(hn)-0.1,max(hn)+0.1];
stem(n,hn,'fill'); axis(xylim)
```

```
xlabel('n', 'fontsize', LFS); ylabel('h[n]', 'fontsize', LFS);
title('5-Point Moving Average Filter Impulse Response', ...
      'fontsize', TFS);
```

9. (a) Proof:

$$\begin{aligned}\sum_{n=0}^{\infty} a^n &= 1 + a + a^2 + \dots \\ a \sum_{n=0}^{\infty} a^n &= a + a^2 + a^3 + \dots \\ (1-a) \sum_{n=0}^{\infty} a^n &= 1 + (a-a) + (a^2-a^2) + \dots + (a^\infty - a^\infty) \\ (1-a) \sum_{n=0}^{\infty} a^n &= 1 + 0 + 0 + \dots + 0 \\ \sum_{n=0}^{\infty} a^n &= \frac{1}{1-a}\end{aligned}$$

(b) Proof:

$$\sum_{n=0}^{N-1} a^n = \sum_{n=0}^{\infty} a^n - \sum_{n=N}^{\infty} a^n = \sum_{n=0}^{\infty} a^n - a^N \sum_{n=0}^{\infty} a^n$$

Substituting the result in part (a), we have

$$\sum_{n=0}^{N-1} a^n = (1 - a^N) \sum_{n=0}^{\infty} a^n = \frac{1 - a^N}{1 - a}$$

10. (a) Solution:

$$\begin{aligned}x[-m] &= \{-1, 2, 3, 1\} \\ x[3-m] &= \{-1, 2, 3, 1\} \\ h[m] &= \{2, 2(0.8)^1, 2(0.8)^2, 2(0.8)^3, 2(0.8)^4, 2(0.8)^5, 2(0.8)^6\} \\ x[3-m] * h[m] &= \{-2, 4(0.8)^1, 6(0.8)^2, 2(0.8)^3\} \\ y[3] &= \sum_{m=0}^3 x[3-m] * h[m] = 6.064\end{aligned}$$

(b) MATLAB script:

```
% P0210: Graphically illustrate the convolution sum
close all; clc
nx = 0:3;
x = [1,3,2,-1]; % input sequence
nh = 0:6;
h = 2*(0.8).^nh; % impulse response
nxf = fliplr(-nx); xf = fliplr(x); %folding
nxfs = nxf+3; % left shifting
[y1 y2 n] = timealign(xf,nxfs,h,nh);
y = y1.*y2;
y3 = sum(y);
%Plot
hf = figconfg('P0210');
subplot(5,1,1)
stem(nx,x,'fill')
axis([-4 7 min(x)-1 max(x)+1])
ylabel('x[k]', 'fontsize',LFS);
subplot(5,1,2)
stem(nh,h,'fill')
axis([-4 7 min(h)-1 max(h)+1])
ylabel('h[k]', 'fontsize',LFS);
subplot(5,1,3)
stem(nxf,xf,'fill')
axis([-4 7 min(x)-1 max(x)+1])
ylabel('x[-k]', 'fontsize',LFS);
subplot(5,1,4)
stem(nxfs,xf,'fill')
axis([-4 7 min(x)-1 max(x)+1])
ylabel('x[-k+3]', 'fontsize',LFS);
subplot(5,1,5)
stem(n,y,'fill')
axis([-4 7 min(y)-1 max(y)+1])
xlabel('k', 'fontsize',LFS);
ylabel('h[k]*x[-k+3]', 'fontsize',LFS);
```

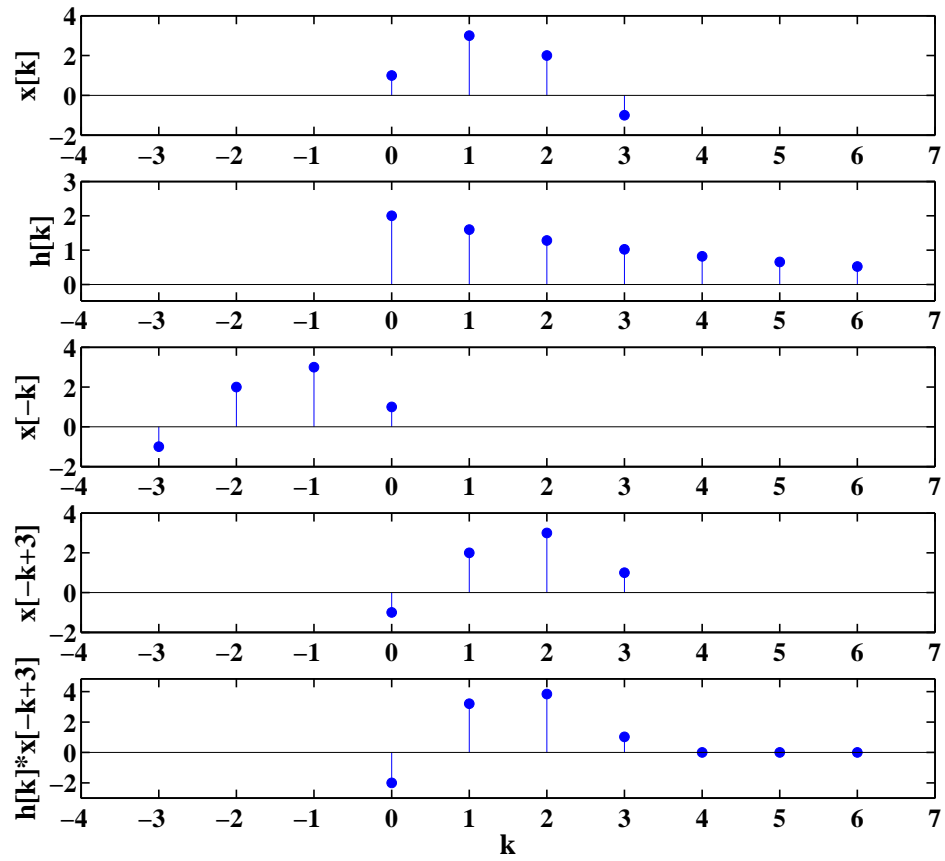

FIGURE 2.16: Graphically illustration of convolution as a superposition of scaled and scaled replicas.

11. Comments: The step responses of the two equivalent system representations are equal.

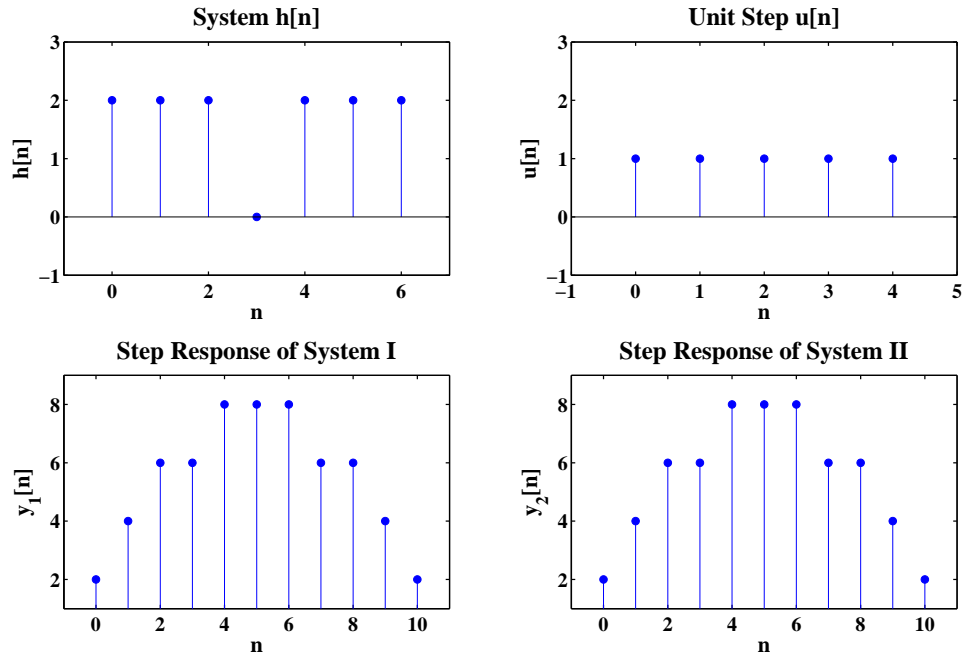

FIGURE 2.17: Illustrating equivalent system representation.

MATLAB script:

```
% P0211: Illustrating the combination of parallel and
%         series systems
close all; clc
n1 = 0:4;
h1 = ones(1,5);
h2 = [1 -1 -1 -1 1];
n2 = 0:2;
h3 = ones(1,3);
[h n] = conv0(h1+h2,n1,h3,n2);
un = unitstep(n1(1),0,n1(end));
[ytemp1 nyt] = conv0(h1,n1,un,n1);
ytemp2 = conv(h2,un);
```

```

[y1 ny1] = conv0(h3,n2,ytemp1+ytemp2,nyt);
[y2 ny2] = conv0(h,n,un,n1);
%Plot
hf = figconfg('P0211');
subplot(2,2,1)
stem(n,h,'fill')
axis([n(1)-1 n(end)+1 min(h)-1 max(h)+1])
xlabel('n','fontsize',LFS);
ylabel('h[n]','fontsize',LFS);
title('System h[n]','fontsize',TFS);
subplot(2,2,2)
stem(n1,un,'fill')
axis([n1(1)-1 n1(end)+1 min(h)-1 max(h)+1])
xlabel('n','fontsize',LFS);
ylabel('u[n]','fontsize',LFS);
title('Unit Step u[n]','fontsize',TFS);
subplot(2,2,3)
stem(ny1,y1,'fill')
axis([ny1(1)-1 ny1(end)+1 min(y1)-1 max(y1)+1])
xlabel('n','fontsize',LFS);
ylabel('y_1[n]','fontsize',LFS);
title('Step Response of System I','fontsize',TFS);
subplot(2,2,4)
stem(ny2,y2,'fill')
axis([ny1(1)-1 ny1(end)+1 min(y2)-1 max(y2)+1])
xlabel('n','fontsize',LFS); ylabel('y_2[n]','fontsize',LFS);
title('Step Response of System II','fontsize',TFS);

```

12. MATLAB script:

```

% P0212: Illustrating the usage of function 'convmtx'
close all; clc
nx = 0:5; nh = 0:3;
x = ones(1,6); h = 0.5.^(0:3);

A = convmtx(x,length(h));
y = h*A; % compute convolution
ny = (nx(1)+nh(1)):(nx(end)+nh(end)); % compute support
% [y2 ny2] = conv0(x,nx,h,nh);
%Plot

```

```

hf = figconf('P0212','small');
stem(ny,y,'fill')
axis([ny(1)-1 ny(end)+1 min(y)-1 max(y)+1])
xlabel('n','fontsize',LFS); ylabel('y[n]','fontsize',LFS);
title('Convolution y[n]','fontsize',TFS);
set(gca,'XTick',ny(1):ny(end))

```

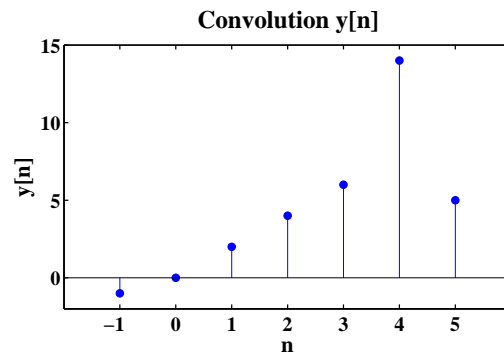

FIGURE 2.18: Compute the convolution of the finite length sequences in (2.38) using `convmtx`.

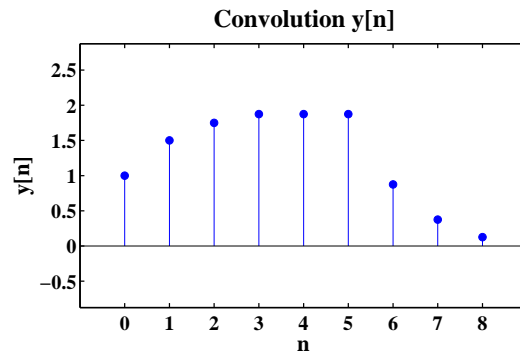

FIGURE 2.19: Compute the convolution of the finite length sequences in (2.39) using `convmtx`.

13. Proof:

Since the linear time-invariant system is stable, we have

$$\sum_{n=-\infty}^{\infty} |h[n]| < \infty$$

$$\sum_{n=-\infty}^{\infty} |h[n]| = \lim_{N \rightarrow \infty} \left(\sum_{n=-\infty}^N |h[n]| + \sum_{n=N+1}^{\infty} |h[n]| \right)$$

$$\lim_{N \rightarrow \infty} \left(\sum_{n=N+1}^{\infty} |h[n]| \right) = 0$$

$$y[n] = x[n] * h[n] = \sum_{m=-\infty}^{\infty} h[m]x[n-m] = \sum_{m=n-n_0}^{\infty} h[m]x[n-m]$$

$$\lim_{n \rightarrow \infty} |y[n]| = \lim_{n \rightarrow \infty} \left| \sum_{m=n-n_0}^{\infty} h[m]x[n-m] \right| \leq \lim_{n \rightarrow \infty} \sum_{m=n-n_0}^{\infty} |h[m]||x[n-m]| = 0$$

Hence, we proved

$$\lim_{n \rightarrow \infty} y[n] = 0$$

14. MATLAB script:

```
% P0214: Use function 'conv(h,x)' to compute noncausal
%         h convolves causal x
close all; clc
nh = -4:4;
nx = 0:5;
h = ones(1,9);
x = 1:6;
y1 = conv(h,x); % compute convolution
ny1 = (nh(1)+nx(1)):(nh(end)+nx(end)); % define support
[y2 ny2] = conv0(h,nh,x,nx); % verification
```

15. Comments: The image is blurred by both filters and the larger the filter is the more blurred the image is.

MATLAB script:

```
% P0215: Filtering 2D image lena.jpg using 2D filter
close all; clc
x = imread('lena.jpg');
% Part (a): image show
hfs = figconfg('P0215a','small');
imshow(x,[])
% Part (b):
hmn = ones(3,3)/9;
y1 = filter2(hmn,x);
% hmn is symmetric and no change if rotated by 180 degrees
% we can use 2d correlation instead of 2d convolution
hfs1 = figconfg('P0215b','small');
imshow(y1,[])
% Part (c):
hmn2 = ones(5,5)/25;
y2 = filter2(hmn2,x);
hfs2 = figconfg('P0215c','small');
imshow(y2,[])
```



(a)



(b)

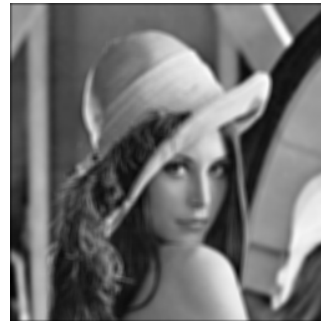

(c)

FIGURE 2.20: (a) Original image. (b) Output image processed by 3×3 impulse response $h[m, n]$ given in (2.75). (c) Output image processed by 5×5 impulse response $h[m, n]$ defined in part (c).

16. (a) See plots.
(b) Comments: The resulting image is horizontally blurred.
(c) Comments: The resulting image is vertically blurred.
(d) Comments: The resulting image is blurred the same way as the one in part (c) in Problem 16.

MATLAB script:

```
% P0216: Filtering 2D image lena.jpg using 1D filter
x = imread('lena.jpg');
[nx ny] = size(x);
% Part (a): image show
hfs = figconfg('0216a','small');
imshow(x,[])
n = -2:2;
h = ones(1,5)/5;
% Part (b): horizontal filtering
yh = zeros(nx,ny);
for ii = 1:ny
    temp = conv(h,double(x(ii,:)));
    yh(ii,:) = temp(3:end-2);
end
hfs1 = figconfg('0216b','small');
imshow(yh,[])
% Part (c): vertical filtering
yv = zeros(nx,ny);
for ii = 1:nx
    temp = conv(h,double(x(:,ii)));
    yv(:,ii) = temp(3:end-2);
end
hfs2 = figconfg('0216c','small');
imshow(yv,[])
% Part (d): horizontal and vertical filtering
yhv = zeros(nx,ny);
for ii = 1:nx
    temp = conv(h,yh(:,ii));
    yhv(:,ii) = temp(3:end-2);
end
hfs3 = figconfg('0216d','small');
imshow(yhv,[])
```



(a)

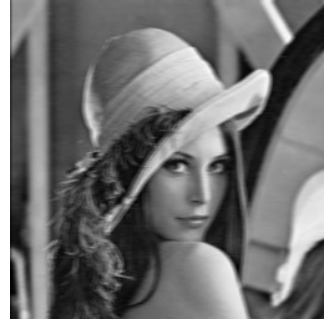

(b)



(c)

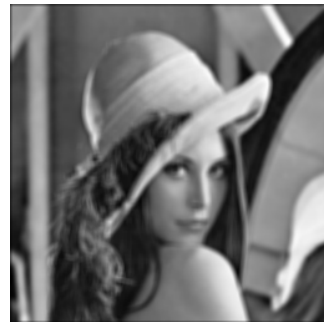

(d)

FIGURE 2.21: (a) Original image. (b) Output image obtained by row processing. (c) Output image obtained by column processing. (d) Output image obtained by row and column processing.

17. (a) Impulse response.

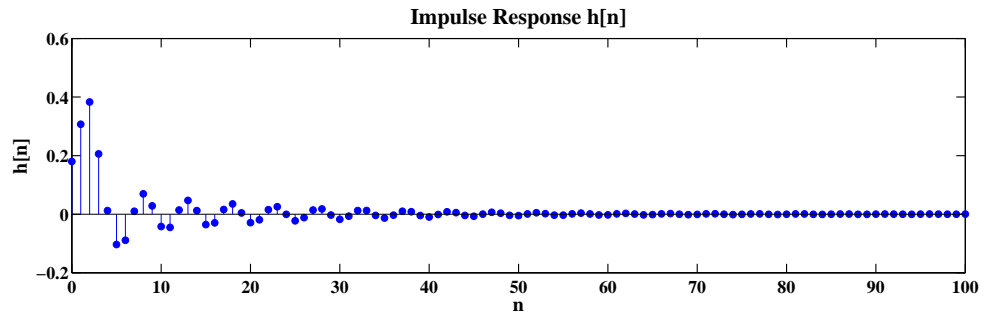

FIGURE 2.22: Impulse response $h[n]$.

- (b) Output using `y=filter(b,a,x)`.

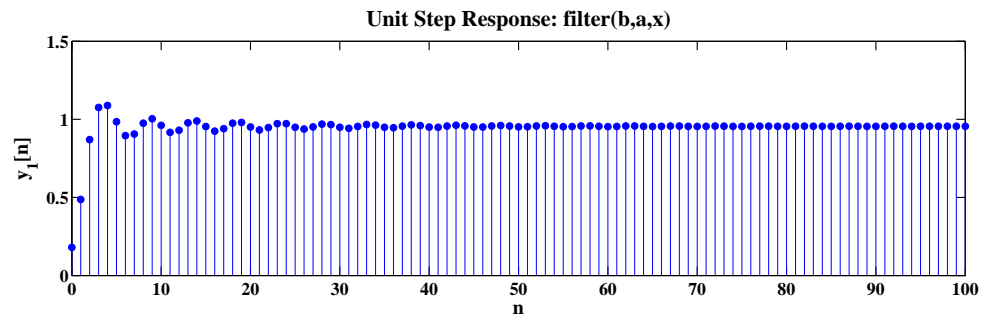

FIGURE 2.23: System step output $y[n]$ computed using the function `y=filter(b,a,x)`.

- (c) Output using `y=conv(h,x)`.

- (d) Output using `y=filter(h,1,x)`.

MATLAB script:

```
% P0217: Illustrating the usage of functions 'impz','filter','conv'
close all; clc
n = 0:100;
b = [0.18 0.1 0.3 0.1 0.18];
a = [1 -1.15 1.5 -0.7 0.25];
% Part (a):
```

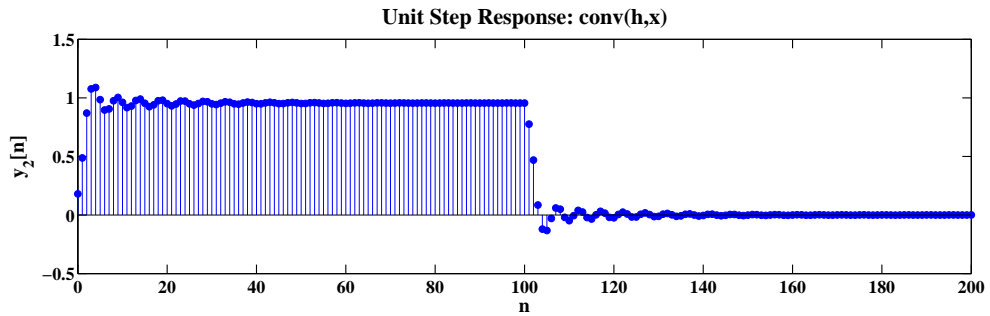

FIGURE 2.24: System step output $y[n]$ computed using the function $y=\text{conv}(h,x)$.

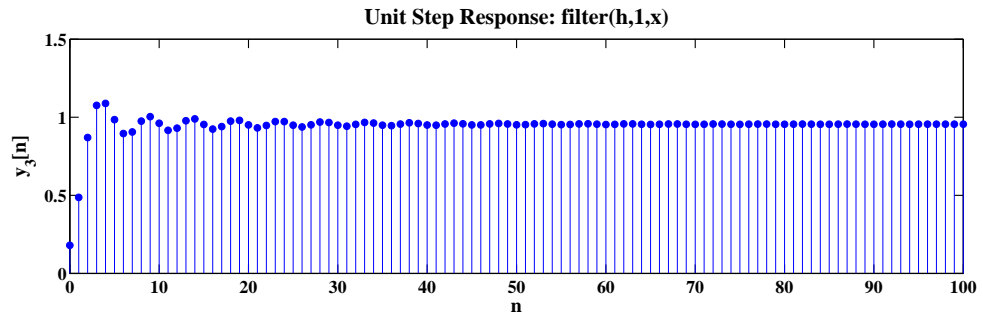

FIGURE 2.25: System step output $y[n]$ computed using the function $y=\text{filter}(h,1,x)$.

```

h = impz(b,a,length(n));
% Part (b):
u = unitstep(n(1),0,n(end));
y1 = filter(b,a,u);
% Part (c):
y2 = conv(h,u);
% Part (d):
y3 = filter(h,1,u);
%Plot
hf = figconf('P0217a','long');
stem(n,h,'fill')
xlabel('n','fontsize',LFS); ylabel('h[n]','fontsize',LFS);
title('Impulse Response h[n]','fontsize',TFS);

```

```

hf2 = figconfg('P0217b','long');
stem(n,y1,'fill')
xlabel('n','fontsize',LFS); ylabel('y_1[n]','fontsize',LFS);
title('Unit Step Response: filter(b,a,x)','fontsize',TFS);
hf3 = figconfg('P0217c','long');
stem(0:2*n(end),y2,'fill')
xlabel('n','fontsize',LFS); ylabel('y_2[n]','fontsize',LFS);
title('Unit Step Response: conv(h,x)','fontsize',TFS);
hf4 = figconfg('P0217d','long');
stem(n,y3,'fill')
xlabel('n','fontsize',LFS); ylabel('y_3[n]','fontsize',LFS);
title('Unit Step Response: filter(h,1,x)','fontsize',TFS);

```

18. (a) Block diagrams.

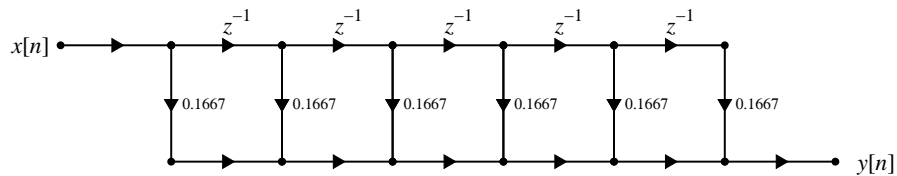

FIGURE 2.26: Block diagram representations of the nonrecursive implementation of $M = 5$ moving average filter.

(b) MATLAB script:

```

% P0218: Implement nonrecursive and recursive implementations
%         of moving average filter
close all; clc
M = 5;
n = 0:M;
un = unitstep(n(1),0,n(end));
% Nonrecursive implementation:
y_nr = filter(ones(1,M+1)/(M+1),1,un);
% Recursive implementation:
y_re = filter([1 zeros(1,M) -1]/(M+1),[1 -1],un);
hf = figconfg('P0218');
subplot(2,1,1)

```

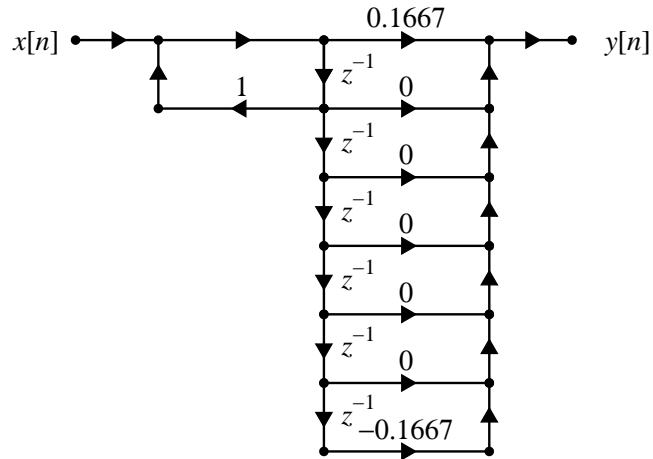

FIGURE 2.27: Block diagram representations of the recursive implementation of $M = 5$ moving average filter.

```

stem(n,y_nr,'fill')
axis([n(1)-1 n(end)+1 min(y_nr)-0.5 max(y_nr)+0.5])
xlabel('n','fontsize',LFS); ylabel('y_1[n]','fontsize',LFS);
title('Nonrecursive Implementation','fontsize',TFS);
subplot(2,1,2)
stem(n,y_re,'fill')
axis([n(1)-1 n(end)+1 min(y_re)-0.5 max(y_re)+0.5])
xlabel('n','fontsize',LFS); ylabel('y_2[n]','fontsize',LFS);
title('Recursive Implementation','fontsize',TFS);

```

19. MATLAB script:

```

% P0219: Generate digital reverberation using audio file 'handel'
close all; clc
load('handel.mat')
n = 1:length(y);
a = 0.7; % specify attenuation factor
tau = 50e-3; % Part (a)

```

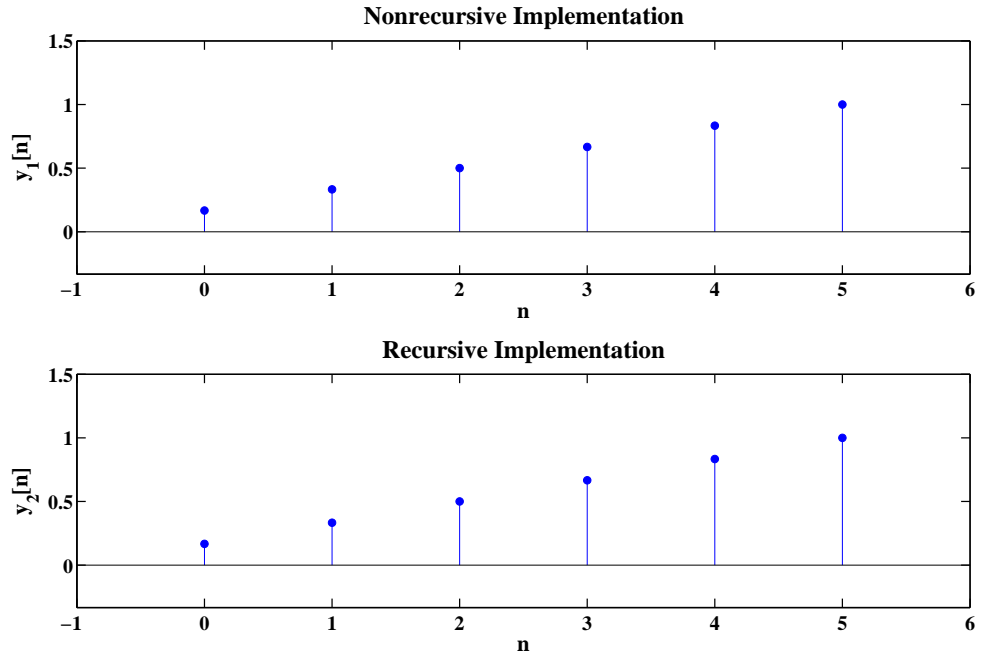

FIGURE 2.28: Step response computed by nonrecursive and recursive implementations.

```
% tau = 100e-3; % Part (b)
% tau = 500e-3; % Part (c)
D = floor(tau*Fs); % compute delay
yd = filter(1,[1 zeros(1,length(D)-1)],-a,y);
sound(yd,Fs)
```

20. (a) Solution:

$$\begin{aligned}
 y_1(t) &= x_1(t) * h(t) = \int_{-\infty}^{\infty} h(\tau)x_1(t - \tau)d\tau = \int_{-\infty}^{\infty} e^{-\tau/2}u(\tau)u(t - \tau)d\tau \\
 &= u(t) \int_0^t e^{-\tau/2}d\tau = u(t)(-2)e^{-\tau/2}\Big|_0^t = 2(1 - e^{-t/2})u(t)
 \end{aligned}$$

$$\begin{aligned}
y_2(t) &= x_2(t) * h(t) = \int_{-\infty}^{\infty} h(t - \tau)x_2(\tau)d\tau = 2 \int_0^3 e^{-(t-\tau)/2}u(t - \tau)d\tau \\
&= (u(t) - u(t - 3))2 \int_0^t e^{-(t-\tau)/2}d\tau + u(t - 3)2 \int_0^3 e^{-(t-\tau)/2}d\tau \\
&= (u(t) - u(t - 3))4e^{-(t-\tau)/2}\Big|_0^t + u(t - 3)4e^{-(t-\tau)/2}\Big|_0^3 \\
&= 4(1 - e^{-t/2})u(t) - 4(1 - e^{-(t-3)/2})u(t - 3)
\end{aligned}$$

(b) Proof:

$$\begin{aligned}
x_2(t) &= 2x_1(t) - 2x_1(t - 3) \\
y_2(t) &= 2y_1(t) - 2y_1(t - 3) \\
&= 4(1 - e^{-t/2})u(t) - 4(1 - e^{-(t-3)/2})u(t - 3)
\end{aligned}$$

Basic Problems

21. See book companion toolbox for the function.
22. (a) $x[n]$ versus n .

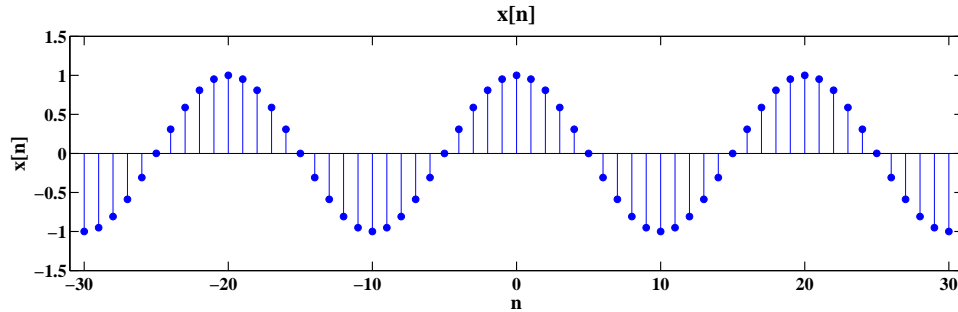
FIGURE 2.29: $x[n]$ versus n .

- (b) A down sampled signal $y[n]$ for $M = 5$.

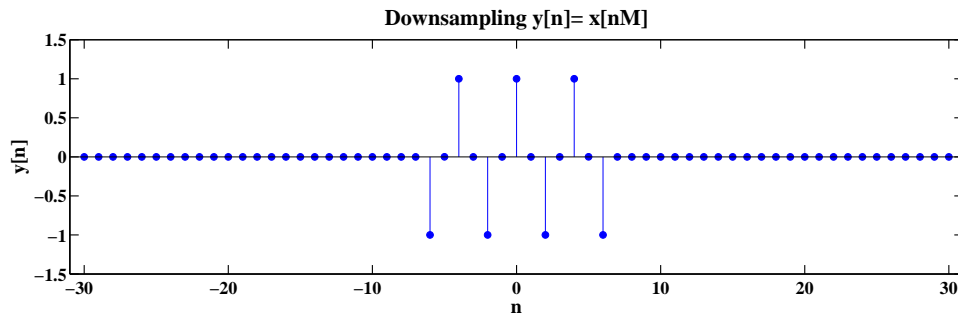
FIGURE 2.30: A down sampled signal $y[n]$ for $M = 5$.

- (c) A down sampled signal $y[n]$ for $M = 20$.
- (d) Comments: The downsampled signal is compressed.

MATLAB script:

```
% P0222: Illustrate downsampling:  $y[n] = x[nM]$ 
close all; clc
nx = -30:30;
x = cos(0.1*pi*nx);
```

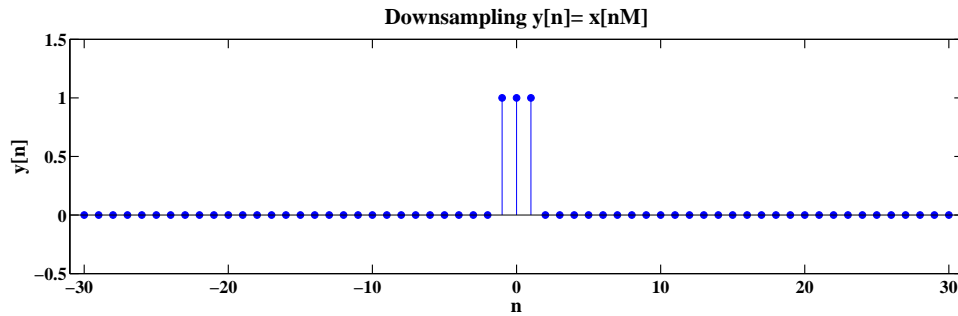
FIGURE 2.31: A down sampled signal $y[n]$ for $M = 20$.

```

% M = 5; % Part (b)
M = 20; % Part (c)
yind = mod(nx,M)==0;
y = x(yind);
ny = nx(yind)/M;
[x y n] = timealign(x,nx,y,ny);
hf = figconfg('P0222a','long');
stem(n,x,'fill')
axis([n(1)-1 n(end)+1 min(x)-0.5 max(x)+0.5])
xlabel('n','fontsize',LFS); ylabel('x[n]','fontsize',LFS);
title('x[n]','fontsize',TFS);
hf2 = figconfg('P0222b','long');
stem(n,y,'fill')
axis([n(1)-1 n(end)+1 min(y)-0.5 max(y)+0.5])
xlabel('n','fontsize',LFS); ylabel('y[n]','fontsize',LFS);
title('Downsampling y[n]= x[nM]','fontsize',TFS);

```

23. (a) $y[n] = x[-n]$ (Time-flip)
linear, time-variant, noncausal, and stable
- (b) $y[n] = \log(|x[n]|)$ (Log-magnitude)
nonlinear, time-invariant, causal, and unstable
- (c) $y[n] = x[n] - x[n - 1]$ (First-difference)
linear, time-invariant, causal, and stable
- (d) $y[n] = \text{round}\{x[n]\}$ (Quantizer)
nonlinear, time-invariant, causal, and stable

24. Comments: The filtered data are smoother and $y_1[n]$ is 25 samples delayed than $y_2[n]$.

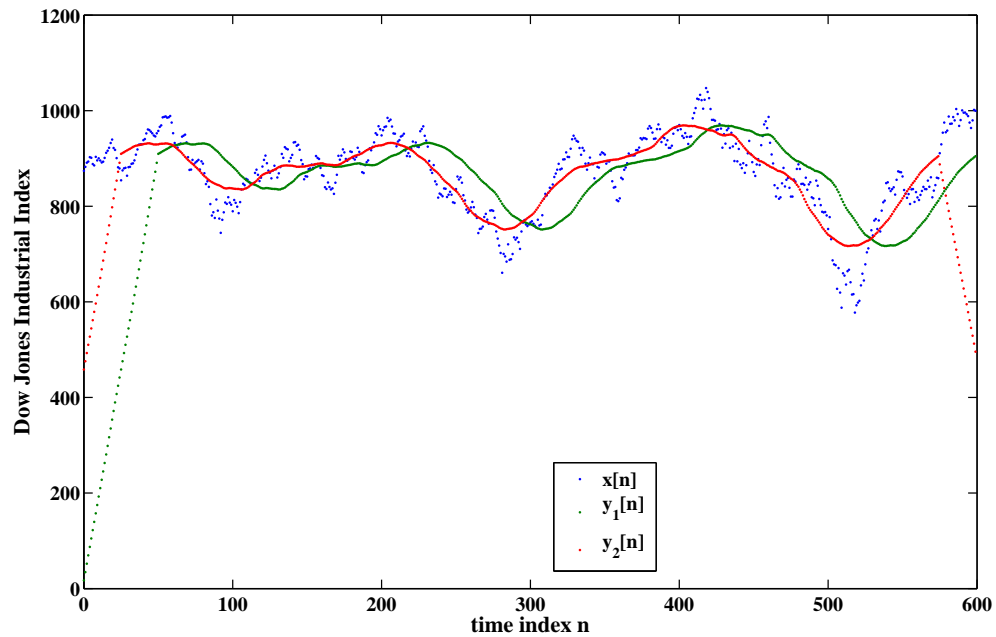

FIGURE 2.32: Dow Jones Industrial Average weekly opening value $x[n]$ and its moving averages.

MATLAB script:

```
% P0224: Write MATLAB script to compute moving averages
close all; clc
x = load('djw6576.txt');
N = length(x);
nx = 0:N-1;
xepd1 = [zeros(50,1);x];
y1 = zeros(N,1);
for ii = 1:N
    y1(ii) = sum(xepd1(ii:ii+50))/51;
end
xepd2 = [zeros(25,1);x;zeros(25,1)];
```

```

y2 = zeros(N,1);
for ii = 1:N
    y2(ii) = sum(xepd2(ii:ii+50))/51;
end
% Plot:
hf = figconfg('P0224');
plot(nx,x, '.',nx,y1, '.',nx,y2, '.')
xlabel('time index n','fontsize',LFS)
ylabel('Dow Jones Industrial Index','fontsize',LFS)
legend('x[n]','y_1[n]','y_2[n]','fontsize',LFS,'location','best')

```

25. (a) Solution:

$$\begin{aligned}
 y[n] &= h[n] * x[n] = \sum_{m=-\infty}^{\infty} h[m]x[n-m] \\
 &= \sum_{m=-\infty}^{\infty} m(u[m] - u[m-M])(u[n-m] - u[n-M-N])
 \end{aligned}$$

if $n \in [0, M-1]$

$$y[n] = \sum_{m=0}^n m = \frac{n(n+1)}{2}$$

if $n \in [M-1, N-1]$

$$y[n] = \sum_{m=0}^{M-1} m = \frac{M(M-1)}{2}$$

if $n \in [N-1, M+N-3]$

$$y[n] = \sum_{m=n-(N-1)}^{M-1} m = \sum_{m=0}^{M-1} m - \sum_{m=0}^{n-N} m = \frac{M(M-1)}{2} - \frac{(n-N+1)(n-N)}{2}$$

(b) Comments: The analytical solution can be verified.

MATLAB script:

```

% P0225: Verify the analytical expression
close all; clc
N = 10; M = 5;
n = 0:N-1;

```

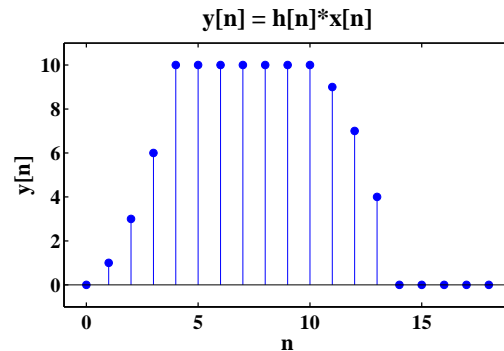

FIGURE 2.33: MATLAB verification of analytical expression for the sequence $y[n] = h[n] * x[n]$.

```

x = unitpulse(0,0,N-1,N-1)';
h = n.*unitpulse(0,0,M-1,N-1)';
[y ny] = conv0(h,n,x,n);
% Plot:
hf = figconfg('P0225','small');
stem(ny,y,'fill')
axis([ny(1)-1,ny(end)+1,min(y)-1,max(y)+1])
xlabel('n','fontsize',LFS); ylabel('y[n]','fontsize',LFS);
title('y[n] = h[n]*x[n]','fontsize',TFS)

```

26. Solution:

$$y[n] = x[n] * h[n] = \sum_{k=-\infty}^{\infty} x[n-k]h[k]$$

if $n \in [0, N-1]$

$$y[n] = \sum_{k=0}^n a^k = \frac{1 - a^{n+1}}{1 - a}$$

if $n \in [N-1, M-1]$

$$y[n] = \sum_{k=n-N+1}^n a^k = \sum_{k=0}^n a^k - \sum_{k=0}^{n-N} a^k = \frac{a^{n+1}(a^{-N} - 1)}{1 - a}$$

$$\text{if } n \in [M - 1, M + N - 2]$$

$$y[n] = \sum_{k=n-N+1}^{M-1} a^k = \sum_{k=0}^{M-1} a^k - \sum_{k=0}^{n-N} a^k = \frac{a^{n-N+1} - a^M}{1 - a}$$

$$y[n] = 0, \quad \text{otherwise}$$

27. Solution:

$$\begin{aligned} y[n] &= h[n] * x[n] = a^n u[n] * b^n u[n] \\ &= \sum_{m=-\infty}^{\infty} a^m u[m] b^{n-m} u[n-m] = u[n] \sum_{m=0}^n a^m b^{n-m} \\ &= u[n] b^n \sum_{m=0}^n a^m b^{-m} = \frac{b^{n+1} - a^{n+1}}{b - a} u[n] \end{aligned}$$

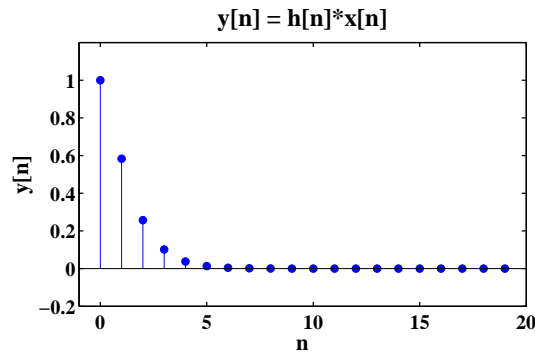

FIGURE 2.34: MATLAB verification of analytical expression for the sequence $y[n] = h[n] * x[n]$.

MATLAB script:

```
% P0227: Verify the analytical expression
close all; clc
a = 1/4; b = 1/3;
N = 20;
n = 0:N-1;
x = a.^n;
h = b.^n;
y = conv(h,x);
```

```

% Plot:
hf = figconf('P0227','small');
stem(n,y(1:N),'fill')
axis([n(1)-1,n(end)+1,min(y)-0.2,max(y)+0.2])
xlabel('n','fontsize',LFS); ylabel('y[n]','fontsize',LFS);
title('y[n] = h[n]*x[n]','fontsize',TFS)

```

28. (a) Solution:

$$\begin{aligned}
 y[n] &= x[n] * h[n] = \sum_{m=-\infty}^{\infty} (0.9)^m u[m] (0.9)^{n-m} u[n-m] \\
 &= u[n] \sum_{m=0}^n (0.9)^n = (n+1)(0.9)^n u[n]
 \end{aligned}$$

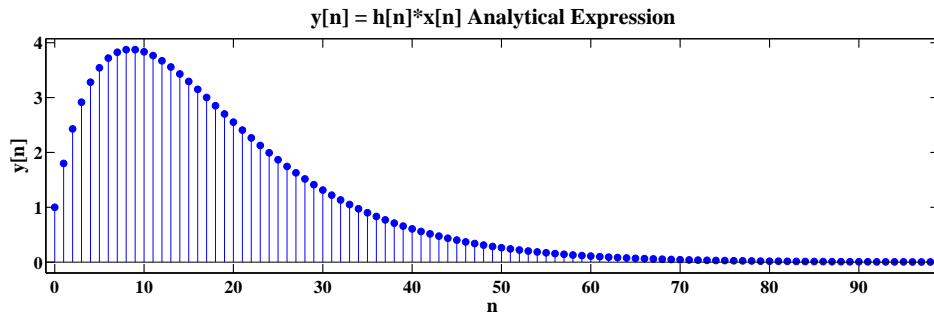

FIGURE 2.35: $y[n]$ plot determined analytically.

- (b) $y[n]$ computed by `conv` function.
- (c) $y[n]$ computed by `filter` function.
- (d) Comments: (c) comes closer to (a). Because in (b) the tail parts (samples from $n = 50$) of both $x[n]$ and $h[n]$ are curtailed, the second part samples (samples from $n = 50$) of (b) differ from the ones in (a).

MATLAB script:

```

% P0228: Verify the analytical expression
close all; clc
a = 0.9;
% Part (a): Analytical Result:

```

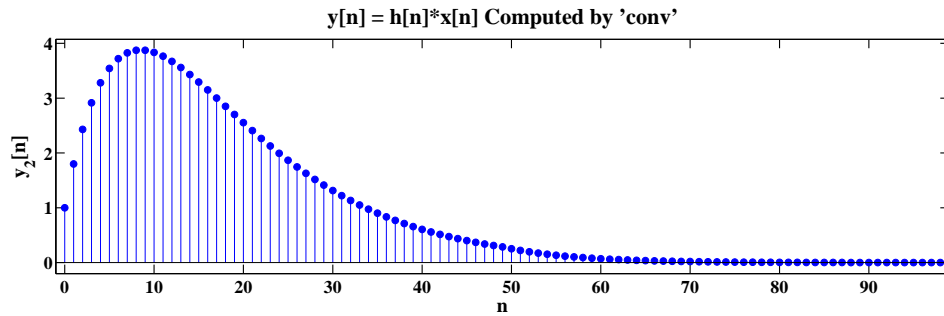
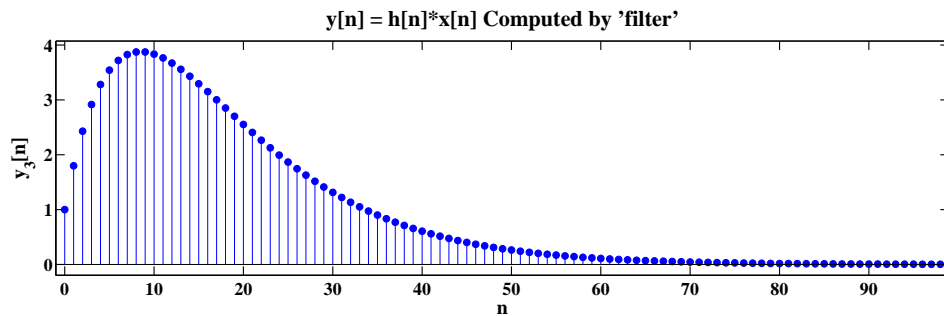
FIGURE 2.36: $y[n]$ plot determined by `conv` function.FIGURE 2.37: $y[n]$ plot determined by `filter` function.

```

n = 0:98;
y1 = (n+1).*a.^n;
% Plot:
hf1 = figconf('P0228a','long');
stem(n,y1,'fill')
axis([n(1)-1,n(end)+1,min(y1)-0.2,max(y1)+0.2])
xlabel('n','fontsize',LFS); ylabel('y[n]','fontsize',LFS);
title('y[n] = h[n]*x[n] Analytical Expression','fontsize',TFS)
% Part (b): Using 'conv'
N = 50;
n = 0:N-1;
x = a.^n;
h = a.^n;
y2 = conv(h,x);
ny = 0:length(y2)-1;

```



```
% Plot:
hf2 = figconfg('P0228b','long');
stem(ny,y2,'fill')
axis([ny(1)-1,ny(end)+1,min(y2)-0.2,max(y2)+0.2])
xlabel('n','fontsize',LFS); ylabel('y_2[n]','fontsize',LFS);
title('y[n] = h[n]*x[n] Computed by ''conv''','fontsize',TFS)
% Part (c): Using 'filter'
N = 99;
n = 0:N-1;
x = a.^n;
h = a.^n;
y3 = filter(h,1,x);
ny = 0:length(y2)-1;
% Plot:
hf3 = figconfg('P0228c','long');
stem(ny,y3,'fill')
axis([ny(1)-1,ny(end)+1,min(y3)-0.2,max(y3)+0.2])
xlabel('n','fontsize',LFS); ylabel('y_3[n]','fontsize',LFS);
title('y[n] = h[n]*x[n] Computed by ''filter''','fontsize',TFS)
```

29. MATLAB script:

```

% P0229: Verify the properites of convolution summarized
%         in Table 2.3 on page 54
close all; clc
%% Specify signals:
nx = -15:9;
x = nx*(-1);
nh = 0:9;
h = 0.5.^nh;
nh1 = 0:20;
h1 = cos(0.05*pi*nh1);
nh2 = -3:5;
h2 = [2 0 0 0 2 0 0 0 -3];
[d nd] = delta(0,0,0); % unit impulse
n0 = 3;
[dd ndd] = delta(n0,n0,n0); % unit delay
%% Verify Identity Property:
y = conv(x,d);
% Plot:
hf1 = figconfg('P0229a');
subplot(2,1,1)
stem(nx,x,'fill')
axis([nx(1)-1,nx(end)+1,min(x)-1,max(x)+1])
xlabel('n','fontsize',LFS); ylabel('x[n]','fontsize',LFS)
title('x[n]','fontsize',TFS)
subplot(2,1,2)
stem(nx,y,'fill')
axis([nx(1)-1,nx(end)+1,min(y)-1,max(y)+1])
xlabel('n','fontsize',LFS); ylabel('y[n]','fontsize',LFS);
title('y[n] = x[n]\times \delta[n]','fontsize',TFS)
%% Verify Delay Property:
[y1 ny1] = shift(x,nx,-n0);
y2 = conv(x,dd);
ny2 = nx + n0;
% Plot:
hf2 = figconfg('P0229b');
subplot(2,1,1)
stem(ny1,y1,'fill')
axis([ny1(1)-1,ny1(end)+1,min(y1)-1,max(y1)+1])

```

```

xlabel('n', 'fontsize', LFS);
title('x[n-n_0]', 'fontsize', TFS)
subplot(2,1,2)
stem(ny2,y2, 'fill')
axis([ny2(1)-1,ny2(end)+1,min(y2)-1,max(y2)+1])
xlabel('n', 'fontsize', LFS)
title('x[n]\times \delta[n-n_0]', 'fontsize', TFS)
%% Verify Commutative Property:
y1 = conv(x,h);
ny1 = nx(1)+nh(1):nx(end)+nh(end);
y2 = conv(h,x);
ny2 = nx(1)+nh(1):nx(end)+nh(end);
% Plot:
hf3 = figconf('P0229c');
subplot(2,1,1)
stem(ny1,y1, 'fill')
axis([ny1(1)-1,ny1(end)+1,min(y1)-1,max(y1)+1])
xlabel('n', 'fontsize', LFS)
title('x[n]\times h[n]', 'fontsize', TFS)
subplot(2,1,2)
stem(ny2,y2, 'fill')
axis([ny2(1)-1,ny2(end)+1,min(y2)-1,max(y2)+1])
xlabel('n', 'fontsize', LFS)
title('h[n]\times x[n]', 'fontsize', TFS)
%% Verify Associative Property:
[y1 ny1] = conv0(x,nx,h1,nh1);
[y1 ny1] = conv0(y1,ny1,h2,nh2);
[y2 ny2] = conv0(h1,nh1,h2,nh2);
[y2 ny2] = conv0(x,nx,y2,ny2);
% Plot:
hf4 = figconf('P0229d');
subplot(2,1,1)
stem(ny1,y1, 'fill')
axis([ny1(1)-1,ny1(end)+1,min(y1)-1,max(y1)+1])
xlabel('n', 'fontsize', LFS)
title('(x[n]\times h_1[n])\times h_2[n]', 'fontsize', TFS)
subplot(2,1,2)
stem(ny2,y2, 'fill')
axis([ny2(1)-1,ny2(end)+1,min(y2)-1,max(y2)+1])
xlabel('n', 'fontsize', LFS)

```

```
title('x[n]\times (h_1[n]\times h_2[n])','fontsize',TFS)
%% Verify Distributive Property:
[hh1 hh2 nh12] = timealign(h1,nh1,h2,nh2);
[y1 ny1] = conv0(x,nx,hh1+hh2,nh12);
[y2a ny2a] = conv0(x,nx,h1,nh1);
[y2b ny2b] = conv0(x,nx,h2,nh2);
[y2a y2b ny2] = timealign(y2a,ny2a,y2b,ny2b);
y2 = y2a + y2b;
% Plot:
hf5 = figconfg('P0229e');
subplot(2,1,1)
stem(ny1,y1,'fill')
axis([ny1(1)-1,ny1(end)+1,min(y1)-1,max(y1)+1])
xlabel('n','fontsize',LFS)
title('x[n]\times (h_1[n]+h_2[n])','fontsize',TFS)
subplot(2,1,2)
stem(ny2,y2,'fill')
axis([ny2(1)-1,ny2(end)+1,min(y2)-1,max(y2)+1])
xlabel('n','fontsize',LFS)
title('x[n]\times h_1[n]+x[n]\times h_2[n]','fontsize',TFS)
```

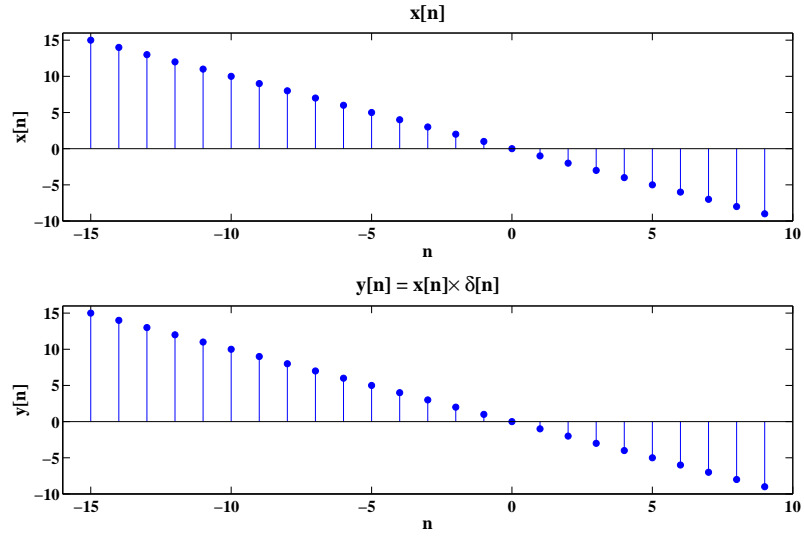

FIGURE 2.38: Verify identity property.

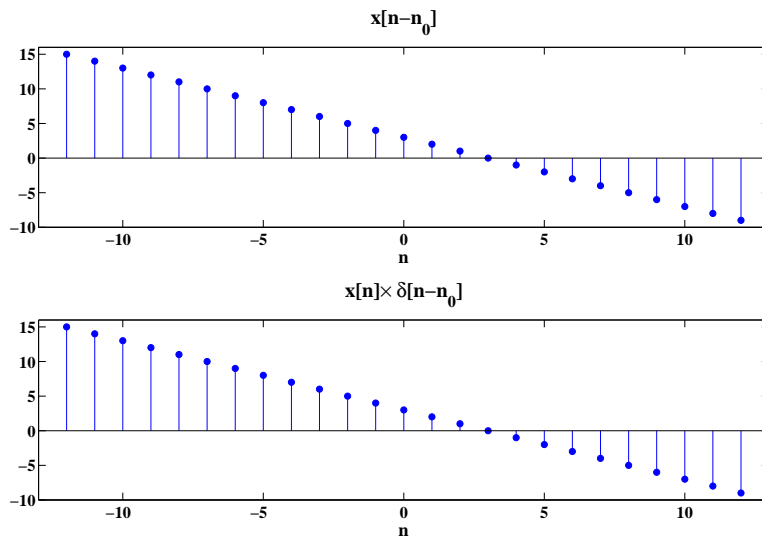

FIGURE 2.39: Verify delay property.

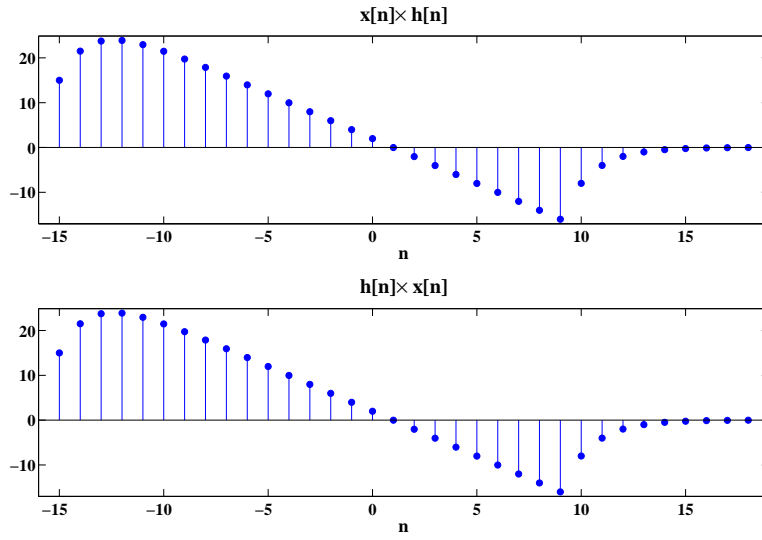

FIGURE 2.40: Verify commutative property.

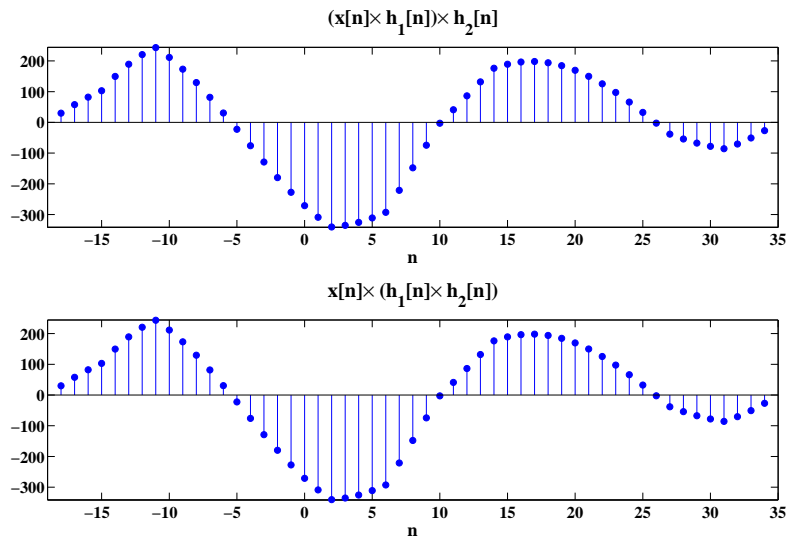

FIGURE 2.41: Verify associative property.

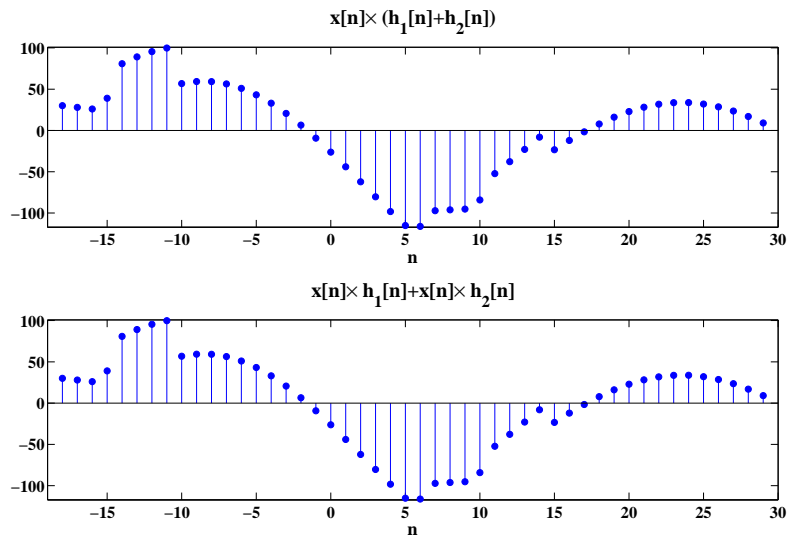

FIGURE 2.42: Verify distributive property.

30. MATLAB script:

```
function [y,L1,L2] = convol(h,M1,M2,x,N1,N2)
% P0230: Compute the convolution of two arbitrarily positioned finite
% length sequences using the procedure illustrated in Figure 2.16
L1 = M1+N1; L2 = M2+N2;
ny = L1:L2;
y = zeros(1,length(ny));
nx = N1:N2;
[hf nhf] = fold(h,M1:M2);
for ii = 1:length(ny)
    [hfs nhfs] = shift(hf,nhf,-ny(ii));
    [y1 y2 ny] = timealign(hfs,nhfs,x,nx);
    y(ii) = sum(y1.*y2);
end
```

31. (a) See below.

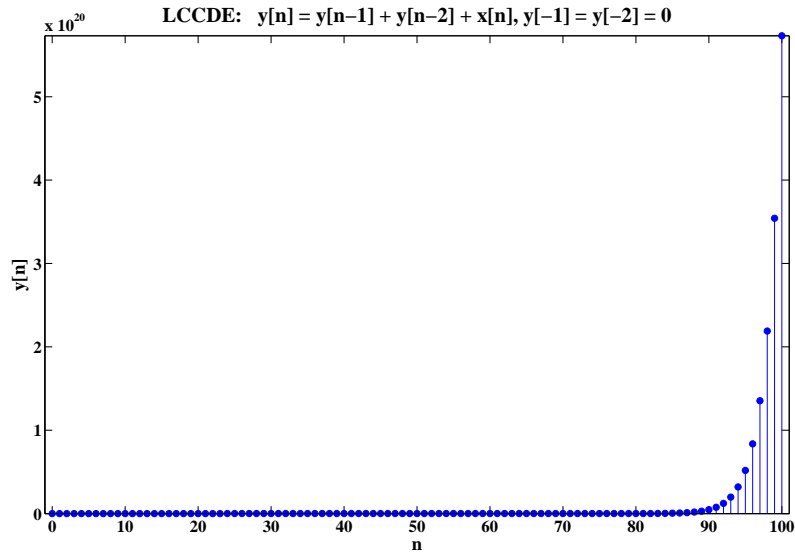

FIGURE 2.43: System impulse response for $0 \leq n \leq 100$, using function `filter`.

(b) Comments: The system is unstable.

(c) Comments: $h[n]$ is 1 sample left moved Fibonacci sequence.

MATLAB script:

```
% P0231: Use function 'filter' to realize LCCDE resting
%         at zero initial condition
close all; clc
% Part (a):
n = 0:100;
x = delta(n(1),0,n(end));
y = filter(1,[1 -1 -1],x);
% Plot:
hf = figconfg('P0231');
stem(n,y,'fill')
axis([n(1)-1,n(end)+1,min(y)-1,max(y)+1])
xlabel('n','fontsize',LFS); ylabel('y[n]','fontsize',LFS)
title('LCCDE:  y[n] = y[n-1] + y[n-2] + x[n], y[-1] = y[-2] = 0'...
      , 'fontsize',TFS)
```

32. MATLAB script:

```

% P0232: Use function 'filter' to study the impulse response and
%         step response of a system specified by LCCDE
close all; clc
N = 60;
n = 0:N-1;
b = [0.18 0.1 0.3 0.1 0.18];
a = [1 -1.15 1.5 -0.7 0.25];
[d nd] = delta(n(1),0,n(end));
[u nu] = unitstep(n(1),0,n(end));
y1 = filter(b,a,d);
y2 = filter(b,a,u);
% Plot:
hf = figconfg('P0232');
subplot(2,1,1)
stem(n,y1,'fill')
axis([n(1)-1,n(end)+1,min(y1)-0.2,max(y1)+0.2])
xlabel('n','fontsize',LFS)
title('Impulse Response','fontsize',TFS);
subplot(2,1,2)
stem(n,y2,'fill')
axis([n(1)-1,n(end)+1,min(y2)-0.5,max(y2)+0.5])
xlabel('n','fontsize',LFS)
title('Step Response','fontsize',TFS)

```

33. MATLAB script:

```

% P0233: Realize a first-order digital differentiator given by
%          $y[n] = x[n] - x[n-1]$ 
close all; clc
% Part (a):
n = -10:19;
x = 10*ones(1,length(n));

% % Part (b):
% nx1 = 0:9;
% x1 = nx1;
% nx2 = 10:19;
% x2 = 20-nx2;

```

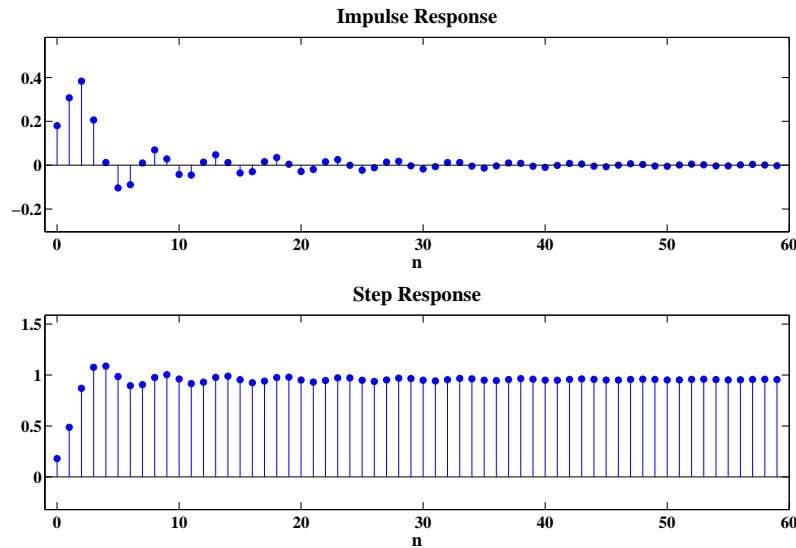

FIGURE 2.44: System impulse response and step response for first 60 samples using function `filter`.

```

% [x1 x2 n] = timealign(x1,nx1,x2,nx2);
% x = x1 + x2;

% % Part (c):
% n = 0:39;
% x = cos(0.2*pi*n-pi/2);

% Differentiator:
y = filter([1,-1],1,x);
% Plot:
hf = figconfg('P0233');
subplot(2,1,1)
stem(n,x,'fill')
axis([n(1)-1,n(end)+1,min(x)-1,max(x)+1])
xlabel('n','fontsize',LFS)
title('Input Signal x[n]','fontsize',TFS)
subplot(2,1,2)
stem(n,y,'fill')

```

```
axis([n(1)-1,n(end)+1,min(y)-1,max(y)+1])
xlabel('n','fontsize',LFS)
title('Response y[n] = x[n] - x[n-1]','fontsize',LFS)
```

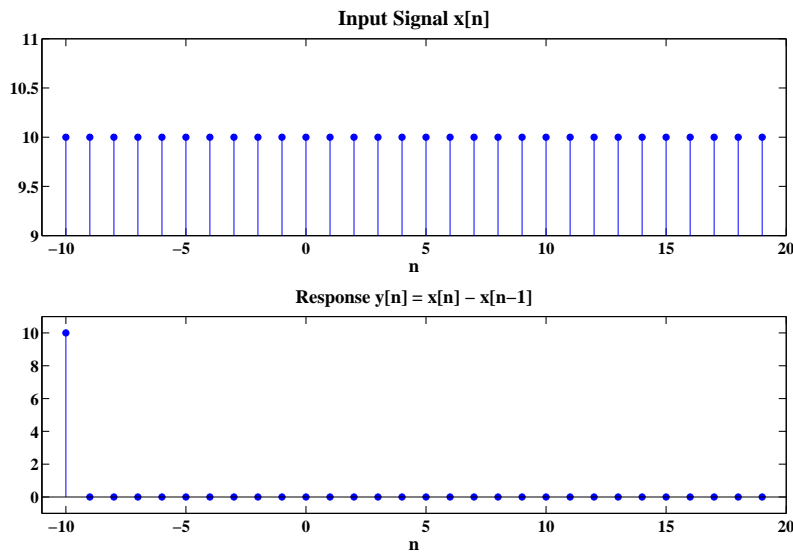

FIGURE 2.45: Differentiator output if input is $x[n] = 10\{u[n + 10] - u[n - 20]\}$.

34. MATLAB script:

```
% P0234: Use function 'filter' to study the impulse response
%         and step response of a system specified by LCCDE
close all; clc
N = 100;
n = 0:N-1;
b = 1;
a = [1 -0.9 0.81];
% a = [1 0.9 -0.81];
[d nd] = delta(n(1),0,n(end));
[u nu] = unitstep(n(1),0,n(end));
y1 = filter(b,a,d);
y2 = filter(b,a,u);
% Plot:
```

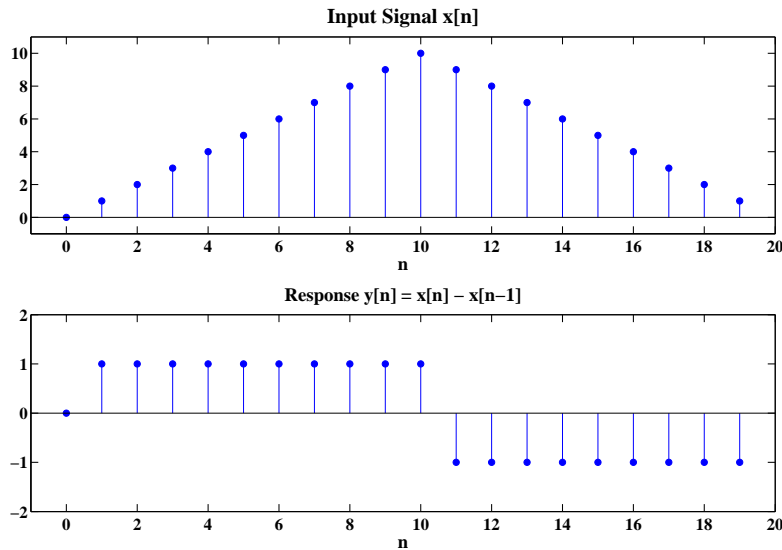

FIGURE 2.46: Differentiator output if input is $x[n] = n\{u[n] - u[n - 10]\} + (20 - n)\{u[n - 10] - u[n - 20]\}$.

```

hf = figconfg('P0234a', 'long');
stem(n,y1, 'fill')
axis([n(1)-1,n(end)+1,min(y1)-1,max(y1)+1])
xlabel('n', 'fontsize', LFS)
title('Impulse Response', 'fontsize', TFS)
hf2 = figconfg('P0234b', 'long');
stem(n,y2, 'fill')
axis([n(1)-1,n(end)+1,min(y2)-1,max(y2)+1])
xlabel('n', 'fontsize', LFS)
title('Step Response', 'fontsize', TFS)

```

35. (a) $y(t) = x(t - 1) + x(2 - t)$
linear, time-variant, noncausal, and stable
- (b) $y(t) = dx(t)/dt$
linear, time-invariant, causal, and unstable
- (c) $y(t) = \int_{-\infty}^{3t} x(\tau) d\tau$
linear, time-variant, noncausal, and unstable

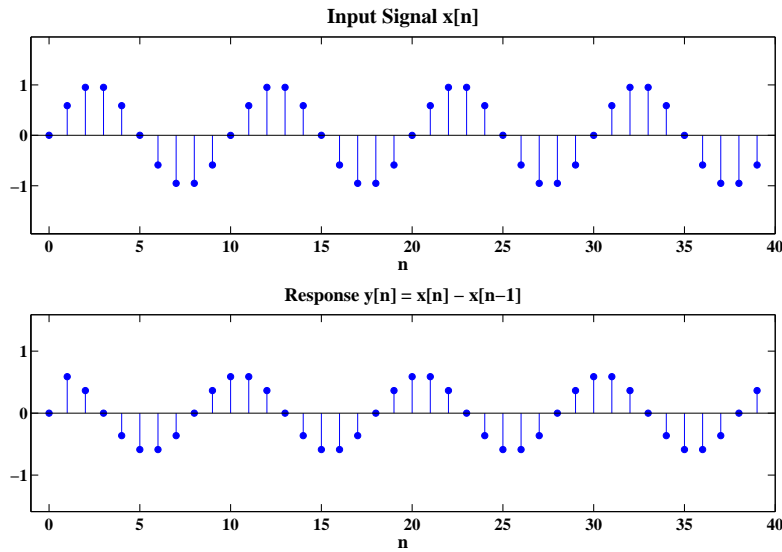

FIGURE 2.47: Differentiator output if input is $x[n] = \cos(0.2\pi n - \pi/2)\{u[n] - u[n - 40]\}$.

- (d) $y(t) = 2x(t) + 5$
 nonlinear, time-invariant, causal, and stable

36. (a) Solution:

$$y(t) = h(t) * x(t) = \int_{-\infty}^{\infty} x(\tau)h(t - \tau)d\tau$$

$$\text{if } t \in [-1, 1]$$

$$y(t) = \int_0^{1+t} \tau/3d\tau = \frac{(1+t)^2}{6}$$

$$\text{if } t \in [1, 2]$$

$$y(t) = \int_{-1+t}^{1+t} \tau/3d\tau = \frac{2t}{3}$$

$$\text{if } t \in [2, 4]$$

$$y(t) = \int_{-1+t}^3 \tau/3d\tau = \frac{-t^2 + 2t + 8}{6}$$

$$y(t) = 0 \quad \text{otherwise}$$

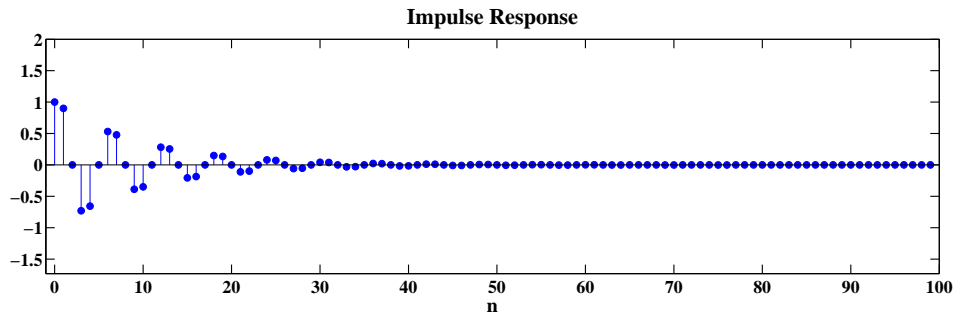

FIGURE 2.48: System impulse response.

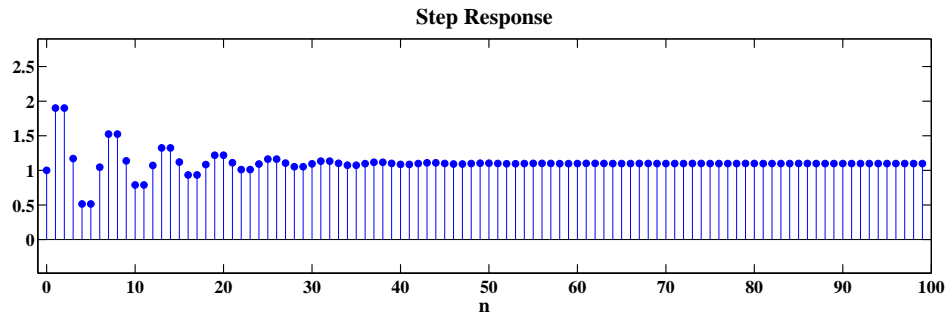

FIGURE 2.49: System step response.

(b) Proof:

$$\begin{aligned}
 y(t) &= h(t) * x(t) = \int_{-\infty}^{\infty} h(\tau)x(t - \tau)d\tau \\
 &= \sum_{k=-\infty}^{\infty} \int_{-\frac{T}{2}}^{\frac{T}{2}} h(kT + \tau)x(t - kT - \tau)d\tau \\
 &\approx \sum_{k=-\infty}^{\infty} [h(kT)x(t - kT)T] \\
 &= T \sum_{k=-\infty}^{\infty} h[k]x[n - k] = \hat{y}(t)
 \end{aligned}$$

(c) Comments: When $T = 0.01$, the error becomes negligible.

MATLAB script:

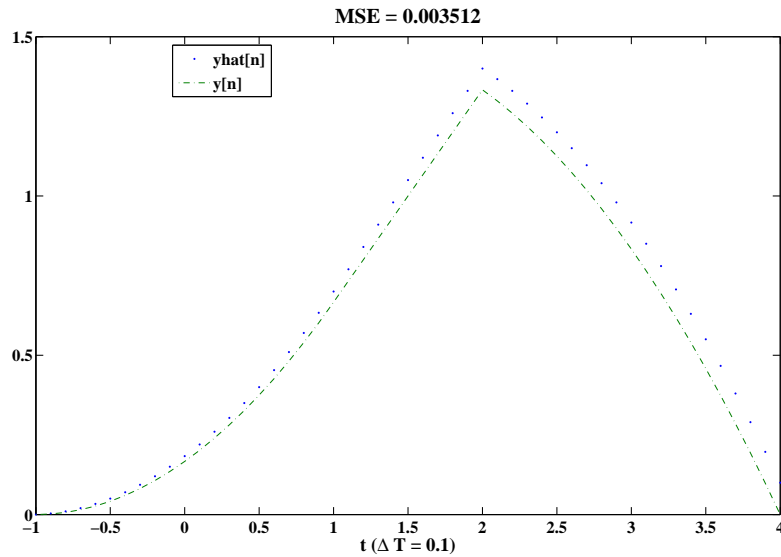
FIGURE 2.50: Plot of sequences $\hat{y}(nT)$ and $y(nT)$ for $T = 0.1$.

```

% P0236: Compute and plot continuous-time convolution
%         using discrete approximation
close all; clc
dT = 0.1;
% % dT = 0.01;
n = -1/dT:4/dT;
t = n*dT;
h = zeros(1,length(n));
ind = (t >= -1 & t <=1);
h(ind) = 1;
x = zeros(1,length(n));
ind = (t >= 0 & t <=3);
x(ind) = t(ind)/3;
% Theoretical continuous y(t):
y = zeros(1,length(n));
ind = (t >= -1 & t <= 1);
y(ind) = (t(ind).^2+2*t(ind)+1)/6;
ind = (t >=1 & t <= 2);
y(ind) = 2*t(ind)/3;
ind = (t >=2 & t <= 4);

```

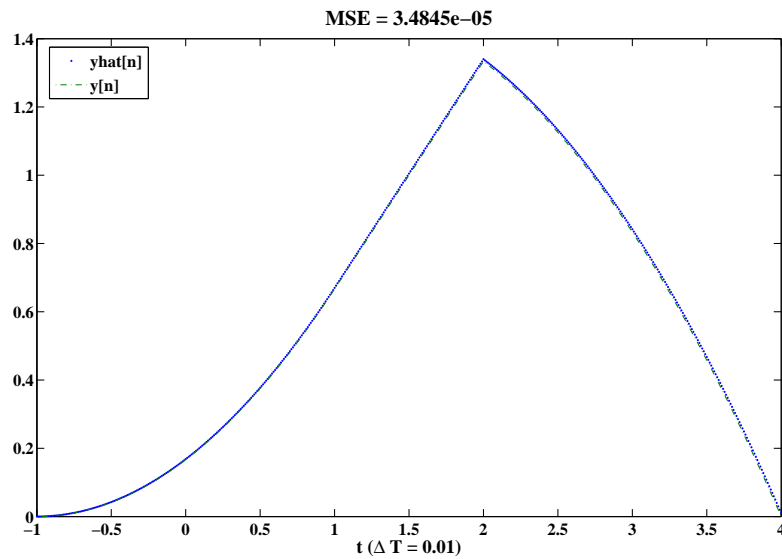
FIGURE 2.51: Plot of sequences $\hat{y}(nT)$ and $y(nT)$ for $T = 0.01$.

```

y(ind) = (-t(ind).^2+2*t(ind)+8)/6;
% Approximated y(t):
[yhat nyhat] = conv0(h,n,x,n);
tyhat = dT*nyhat;
yhat = dT*yhat;
ind = (tyhat <-1 | tyhat>4);
yhat(ind) = [];
% Compute mean square error:
mse = mean((y-yhat).^2);
% Plot:
hf1 = figconfig('P0236');
plot(t,yhat,'.',t,y,'-');
TB = ['MSE = ',num2str(mse)];
title(TB,'fontsize',TFS)
LB = ['t (\Delta T = ',num2str(dT),')'];
xlabel(LB,'fontsize',LFS);
legend('yhat[n]', 'y[n]', 'location', 'best')

```

Assessment Problems

37. Comments: $y_1[n]$ represents the correct $x[-n-4]$ signal.

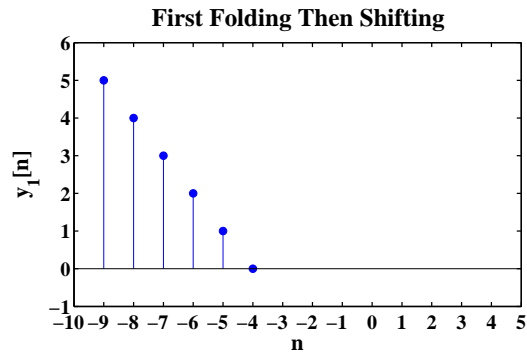

FIGURE 2.52: $y_1[n]$ obtained by first folding and then shifting.

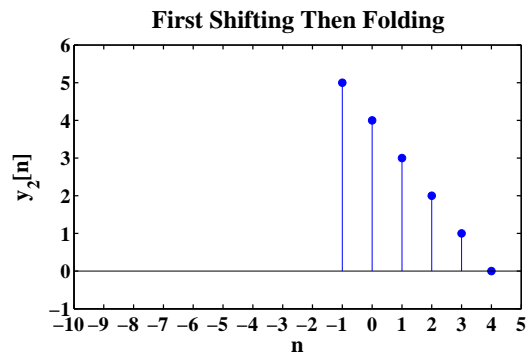

FIGURE 2.53: $y_2[n]$ obtained by first shifting and then folding.

MATLAB script:

```
% P0237: Exercise the manipulations of folding and shifting signals
close all; clc
nx = 0:5;
x = 0:5;
n0 = 4;
% Part (a): First folding, then shifting
[y1 ny1] = fold(x,nx);
[y1 ny1] = shift(y1,ny1,n0);
```

```

% Part (b): First shifting, then folding
[y2 ny2] = shift(x,nx,n0);
[y2 ny2] = fold(y2,ny2);
% Plot:
hf = figconfg('P0237a','small');
stem(ny1,y1,'fill')
xlim([min([ny1(1),ny2(1)])-1,max([ny1(end),ny2(end)])+1])
ylim([min(y1)-1,max(y1)+1])
xlabel('n','fontsize',LFS); ylabel('y_1[n]','fontsize',LFS)
title('First Folding Then Shifting','fontsize',TFS)
set(gca,'Xtick',min([ny1(1),ny2(1)])-1:max([ny1(end),ny2(end)])+1)
hf2 = figconfg('P0237b','small');
stem(ny2,y2,'fill')
xlim([min([ny1(1),ny2(1)])-1,max([ny1(end),ny2(end)])+1])
ylim([min(y2)-1,max(y2)+1])
xlabel('n','fontsize',LFS); ylabel('y_2[n]','fontsize',LFS)
title('First Shifting Then Folding','fontsize',TFS)
set(gca,'Xtick',min([ny1(1),ny2(1)])-1:max([ny1(end),ny2(end)])+1)

```

38. MATLAB script:

```

% P0238: Generate and plot signals using function 'stem'
close all; clc
%% Part (a):
[x1a nx1a] = delta(-1,-1,-1);
x1a = 5*x1a;
nx1b = -5:3;
x1b = nx1b.^2;
nx1c = 4:7;
x1c = 10*0.5.^nx1c;
[x1a x1b nx1] = timealign(x1a,nx1a,x1b,nx1b);
x1 = x1a + x1b;
[x1 x1c nx1] = timealign(x1,nx1,x1c,nx1c);
x1 = x1 + x1c;
% Plot:
hf1 = figconfg('P0238a','small');
stem(nx1,x1,'fill')
axis([min(nx1)-1,max(nx1)+1,min(x1)-1,max(x1)+1])
xlabel('n','fontsize',LFS); ylabel('x_1[n]','fontsize',LFS)
title('x_1[n]','fontsize',TFS)

```

```

set(gca,'Xtick',nx1(1)-1:nx1(end)+1)
%% Part (b):
nx2 = 0:20;
x2 = 0.8.^nx2.*cos(0.2*pi*nx2+pi/4);
% Plot:
hf2 = figconfg('P0238b','small');
stem(nx2,x2,'fill')
axis([min(nx2)-1,max(nx2)+1,min(x2)-0.2,max(x2)+0.2])
xlabel('n','fontsize',LFS); ylabel('x_2[n]','fontsize',LFS)
title('x_2[n]','fontsize',TFS)
%% Part (c):
nx3 = 0:20;
x3 = zeros(1,length(nx3));
for ii = 0:4
    [d1 nd1] = delta(nx3(1),ii,nx3(end));
    [d2 nd2] = delta(nx3(1),2*ii,nx3(end));
    x3 = x3 + (ii+1)*(d1-d2)';
end
% Plot:
hf3 = figconfg('P0238c','small');
stem(nx3,x3,'fill')
axis([min(nx3)-1,max(nx3)+1,min(x3)-1,max(x3)+1])
xlabel('n','fontsize',LFS); ylabel('x_3[n]','fontsize',LFS)
title('x_3[n]','fontsize',TFS)

```

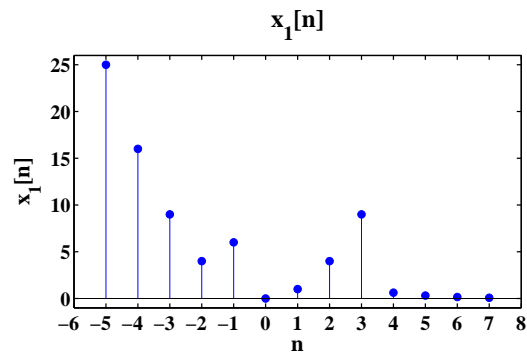

FIGURE 2.54: $x_1[n] = 5\delta[n + 1] + n^2(u[n + 5] - u[n - 4]) + 10(0.5)^n(u[n - 4] - u[n - 8])$.

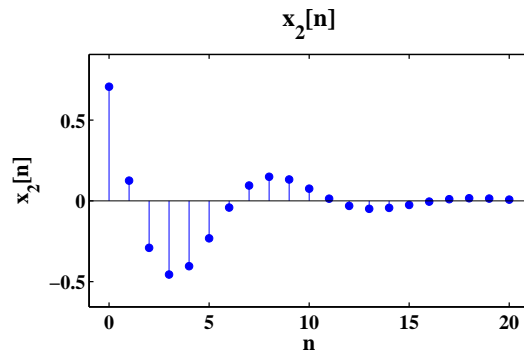

FIGURE 2.55: $x_2[n] = (0.8)^n \cos(0.2\pi n + \pi/4)$, $0 \leq n \leq 20$.

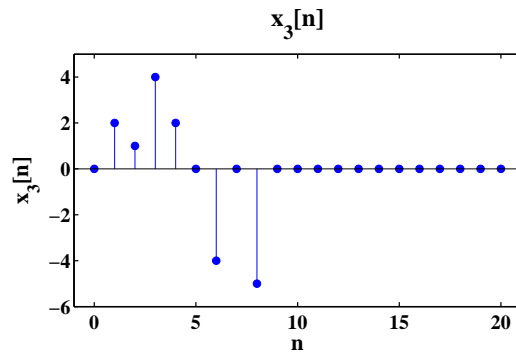

FIGURE 2.56: $x_3[n] = \sum_{m=0}^4 (m+1) \{ \delta[n-m] - \delta[n-2m] \}$, $0 \leq n \leq 20$.

39. MATLAB script:

```
% P0239: Generate and plot signals using function 'stem'
close all; clc
nx = -5:14;
x = nx;
x(x<0) = 0;
x(x>10) = 0;
% Part (a):
[x1 nx1] = shift(x,nx,-4);
x1 = 2*x1;
% Part (b):
[x2 nx2] = shift(x,nx,-5);
```

```

x2 = 3*x2;
% Part (c):
[x3 nx3] = shift(x,nx,3);
[x3 nx3] = fold(x3,nx3);
% Plot:
hf = figconf('P0239');
xlimit = [min([nx(1) nx1(1) nx2(1) nx3(1)])-1,...
          max([nx(end) nx1(end) nx2(end) nx3(end)])+1];
subplot(2,2,1)
stem(nx,x,'fill')
xlim(xlimit); ylim([min(x)-1,max(x)+1])
xlabel('n','fontsize',LFS); title('x[n]','fontsize',LFS)
subplot(2,2,2)
stem(nx1,x1,'fill')
xlim(xlimit); ylim([min(x1)-1,max(x1)+1])
xlabel('n','fontsize',LFS); title('2x[n-4]','fontsize',TFS)
subplot(2,2,3)
stem(nx2,x2,'fill')
xlim(xlimit)
ylim([min(x2)-1,max(x2)+1])
xlabel('n');
title('3x[n-5]')
subplot(2,2,4)
stem(nx3,x3,'fill')
xlim(xlimit); ylim([min(x3)-1,max(x3)+1])
xlabel('n','fontsize',LFS);
title('x[3-n]','fontsize',TFS)

```

40.

$$\begin{aligned}
 T\{a_1x_1[n] + a_2x_2[n]\} &= 10(a_1x_1[n] + a_2x_2[n]) \cos(0.25\pi n + \theta) \\
 &= a_1y_1[n] + a_2y_2[n]
 \end{aligned}$$

The system is linear.

$$\begin{aligned}
 T\{x[n - n_0]\} &= 10x[n - n_0] \cos(0.25\pi n + \theta) \\
 &\neq y[n - n_0] = 10x[n - n_0] \cos(0.25\pi(n - n_0) + \theta)
 \end{aligned}$$

The system is time-variant.

$$h[n] = 10\delta[n] \cos(0.25\pi n + \theta)$$

The system is causal and stable.

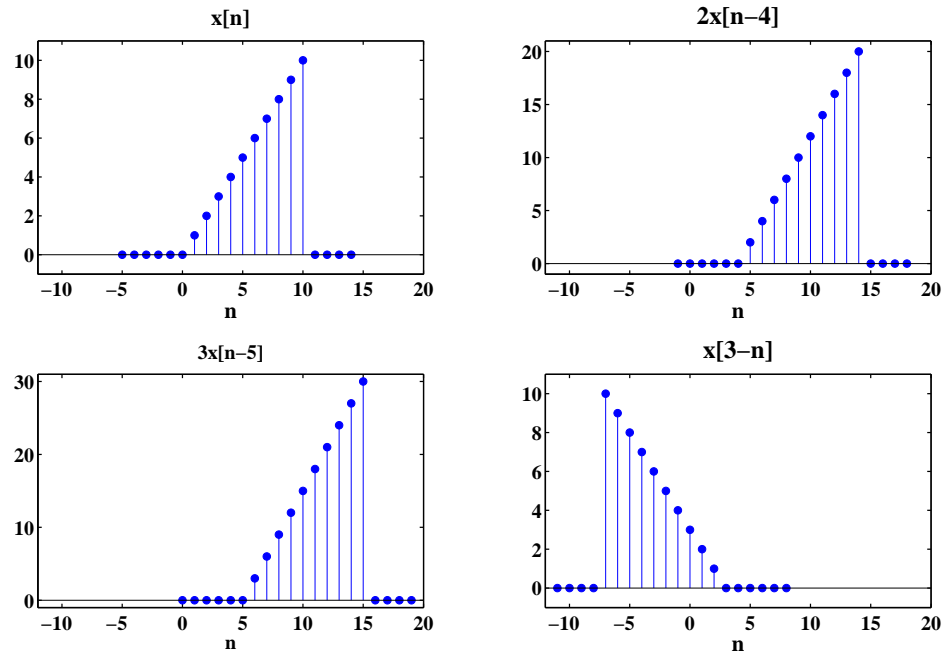
FIGURE 2.57: $x[n]$, $2x[n - 4]$, $3x[n - 5]$, and $x[3 - n]$.

41. Comments: The system is unstable.

MATLAB script:

```
% P0241: Compute and plot the output of the discrete-time system
%       y[n] = 5y[n-1]+x[n], y[-1]=0
close all; clc
n = 0:1e3;
x = ones(1,length(n));
y = filter(1,[1 -5],x);
% Plot:
hf = figconf('P0241','small');
stem(n,y,'fill')
axis([n(1)-1 n(end)+1 min(y)-1 max(y)+1])
xlabel('n','fontsize',LFS);
title('y[n] = 5y[n-1]+x[n], y[-1]=0','fontsize',TFS)
```

42. MATLAB script:

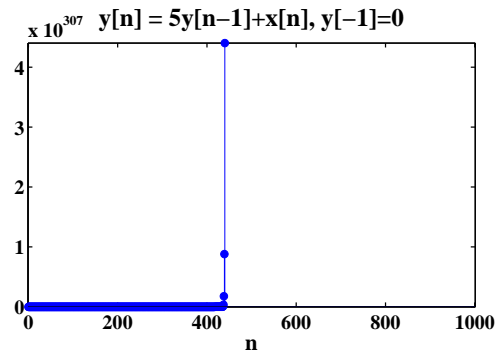

FIGURE 2.58: Step response of system $y[n] = 5y[n-1] + x[n]$, $y[-1] = 0$.

```

% P0242: Compute the outputs of a LTI system defined by
%         'y=agnosto(x)' for different inputs
close all; clc
n = 0:100;
[d nd] = delta(n(1),0,n(end));
h = agnosto(d);
x1 = ones(1,length(n));
x2 = (1/2).^n;
x3 = cos(2*pi*n/20);
y1 = conv(h,x1);
y2 = conv(h,x2);
y3 = conv(h,x3);
% Reference:
yr1 = agnosto(x1);
yr2 = agnosto(x2);
yr3 = agnosto(x3);
% Plot:
hf1 = figconfig('P0242a');
subplot(2,1,1)
stem(n,y1(1:length(n)),'fill')
axis([n(1)-1 n(end)+1 min(y1(1:length(n)))-1 max(y1(1:length(n)))+1])
xlabel('n','fontsize',LFS);
title('y_1[n] Computed by Impulse Response h[n]','fontsize',TFS)
subplot(2,1,2)
stem(n,yr1,'fill')
axis([n(1)-1 n(end)+1 min(yr1)-1 max(yr1)+1])

```

```

xlabel('n','fontsize',LFS);
title('y_1[n] Computed by Function ''agnosto'' Directly','fontsize',TFS)
% Plot:
hf2 = figconfg('P0242b');
subplot(2,1,1)
stem(n,y2(1:length(n)),'fill')
axis([n(1)-1 n(end)+1 min(y2(1:length(n)))-1 max(y2(1:length(n)))+1])
xlabel('n','fontsize',LFS);
title('y_2[n] Computed by Impulse Response h[n]','fontsize',TFS)
subplot(2,1,2)
stem(n,yr2,'fill')
axis([n(1)-1 n(end)+1 min(yr2)-1 max(yr2)+1])
xlabel('n','fontsize',LFS);
title('y_2[n] Computed by Function ''agnosto'' Directly','fontsize',TFS)
% Plot:
hf3 = figconfg('P0242c');
subplot(2,1,1)
stem(n,y3(1:length(n)),'fill')
axis([n(1)-1 n(end)+1 min(y3(1:length(n)))-1 max(y3(1:length(n)))+1])
xlabel('n','fontsize',LFS);
title('y_3[n] Computed by Impulse Response h[n]','fontsize',LFS)
subplot(2,1,2)
stem(n,yr3,'fill')
axis([n(1)-1 n(end)+1 min(yr3)-1 max(yr3)+1])
xlabel('n','fontsize',LFS);
title('y_3[n] Computed by Function ''agnosto'' Directly','fontsize',LFS)

```

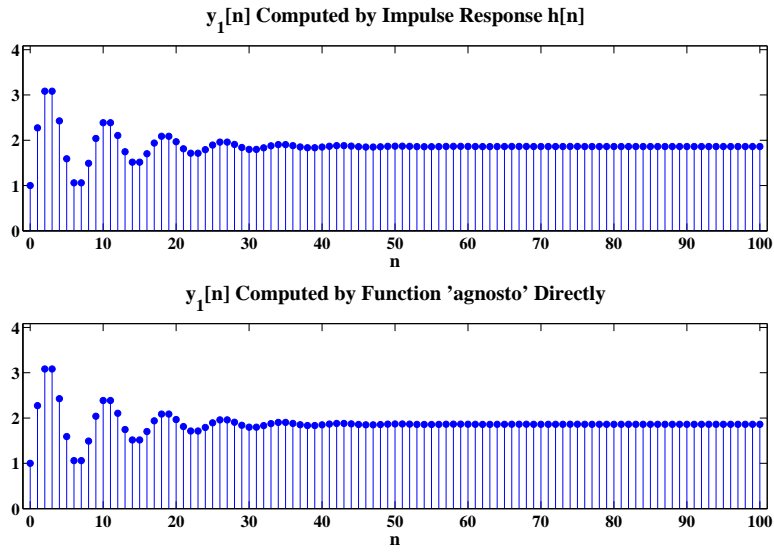



FIGURE 2.59: System response $y_1[n]$ of input $x_1[n] = u[n]$.

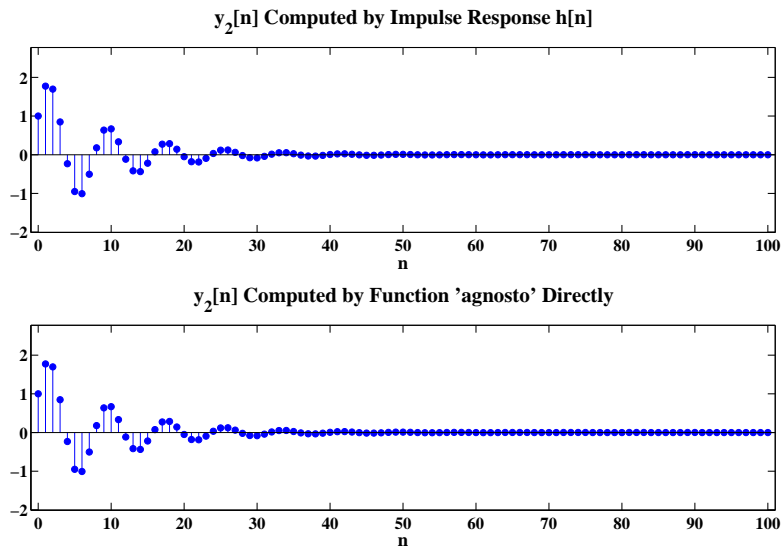
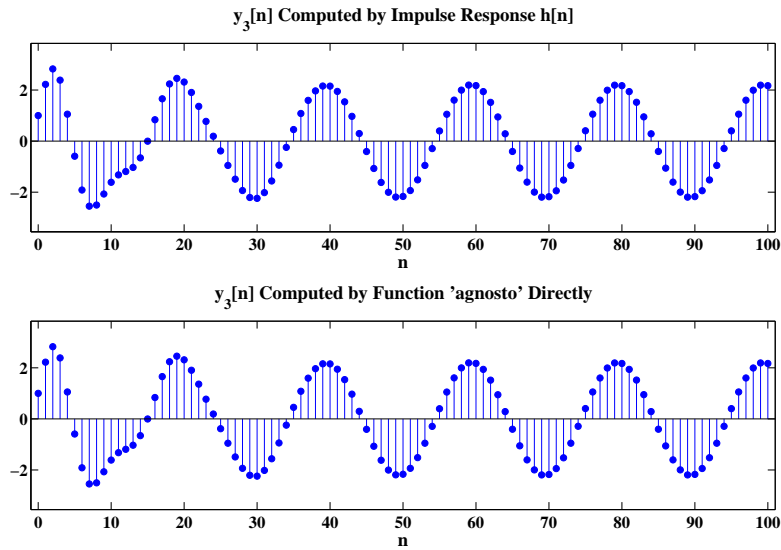

FIGURE 2.60: System response $y_2[n]$ of input $x_2[n] = (1/2)^n$.

FIGURE 2.61: System response $y_3[n]$ of input $x_3[n] = \cos(2\pi n/20)$.

43. (a) Proof:

$$\begin{aligned}
 A_y &= \sum_n y[n] = \sum_n \sum_{k=-\infty}^{\infty} x[k]h[n-k] = \sum_{k=-\infty}^{\infty} x[k] \left(\sum_n h[n-k] \right) \\
 &= \left(\sum_{k=-\infty}^{\infty} x[k] \right) \left(\sum_n h[n] \right) = A_x A_h
 \end{aligned}$$

(b) Comments: $A_y = A_x A_h$

(c) Comments: $A_y = A_x A_h$

MATLAB script:

```

% P0243: Compute the sum of the sequence
close all; clc
nx = 0:100;
x = sin(2*pi*0.01*(0:100)) + 0.05*randn(1,101);
h = ones(1,5);
nh = 0:4;
% Part (b):

```

```

[y ny] = conv0(h,nh,x,nx);
Ay = sum(y);
Ax = sum(x);
Ah = sum(h);
% Plot:
hf1 = figconfg('P0243b','long');
plot(nx,x,'.',ny,y,'.','markersize',16)
xlabel('n','fontsize',LFS);
legend('x[n]','y[n]','fontsize',LFS,'location','best')
% Part (c):
[y2 ny2] = conv0(h/Ah,nh,x,nx);
Ay2 = sum(y2);
% Plot:
hf2 = figconfg('P0243c');
plot(nx,x,'.',ny2,y2,'.','markersize',16)
xlabel('n','fontsize',LFS);
legend('x[n]','y[n]','fontsize',LFS,'location','best')

```

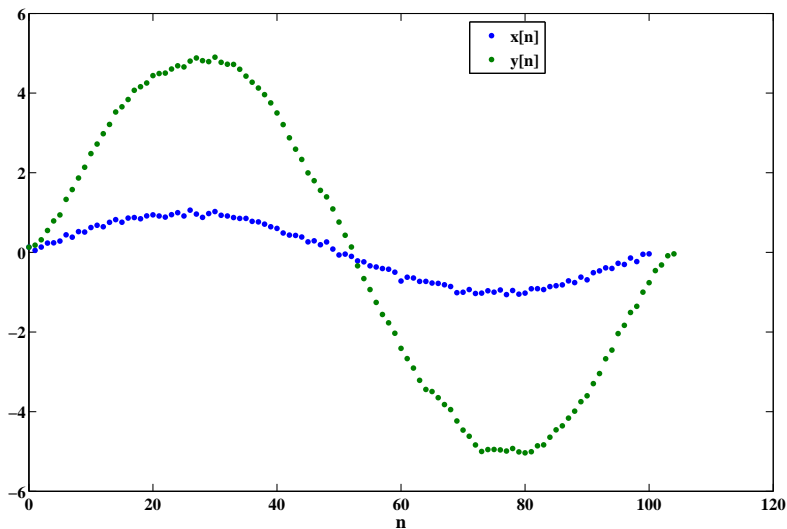
FIGURE 2.62: Plots of $x[n]$ and $y[n]$.

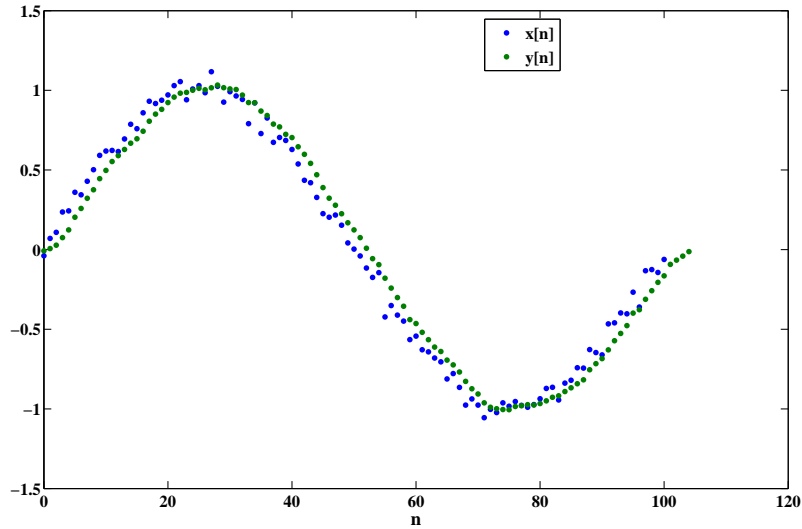
FIGURE 2.63: Plots of $x[n]$ and $y[n]$.

44. Solution:

Constraint that

$$A_h = \sum_n h[n] = 1$$

$$\sum_n h[n] = \sum_n ba^n u[n] = \sum_{n=0}^{\infty} ba^n = \frac{b}{1-a} = 1$$

We choose

$$b = 1 - a$$

The step response can be found:

$$\begin{aligned} s[n] &= h[n] * u[n] = \sum_{m=-\infty}^{\infty} h[m]u[n-m] = \sum_{m=-\infty}^{\infty} ba^m u[m]u[n-m] \\ &= \sum_{m=0}^n ba^m = b \frac{1-a^{n+1}}{1-a} = 1 - a^{n+1} \end{aligned}$$

45. Solution:

$$y[n] = x[n] * h[n] = \sum_{k=-\infty}^{\infty} x[n-k]h[k]$$

if $n \in [0, M-1]$,

$$y[n] = \sum_{k=0}^n a^k = \frac{1-a^{n+1}}{1-a}$$

if $n \in [M-1, N-1]$,

$$y[n] = \sum_{k=0}^{M-1} a^k = \frac{1-a^M}{1-a}$$

if $n \in [N-1, M+N-2]$,

$$\begin{aligned} y[n] &= \sum_{k=n-(N-1)}^{M-1} a^k = \sum_{k=0}^{M-1} a^k - \sum_{k=0}^{n-N} a^k \\ &= \frac{1-a^M}{1-a} - \frac{1-a^{n-N+1}}{1-a} = a^{n-N+1} \frac{(1-a^{M-n+N-1})}{1-a} \end{aligned}$$

otherwise, $y[n] = 0$.

46. Comments: The result highlights line feature oriented horizontally.

MATLAB script:

```
% P0246: Filtering 2D image lena.jpg using 2D Sobel filter
close all; clc
x = imread('lena.jpg');
[nx ny] = size(x);
% Part (a): image show
hfs = figconfg('P0246a','small');
imshow(x, [])
% Part (b): Sobel finding vertical edges
hver = fspecial('sobel');
yver = filter2(hver,x);
hfver = figconfg('P0246b','small');
imshow(yver, [])
% Part (c): Sobel finding horizontal edges
hhor = fspecial('sobel');
yhor = filter2(hhor,x);
hfhor = figconfg('P0246c','small');
imshow(yhor, [])
```



(a)

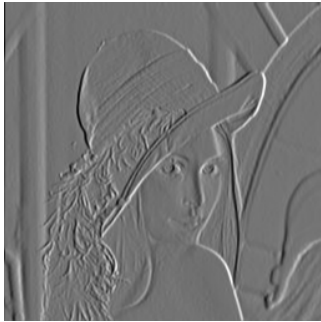

(b)

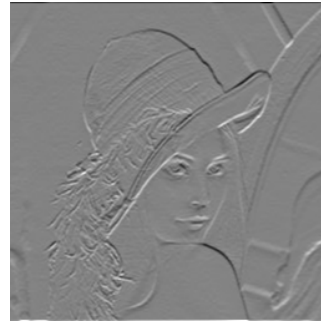

(c)

FIGURE 2.64: (a) Original image. (b) Filtered image using 3×3 vertical Sobel filter. (c) Filtered image using 3×3 horizontal Sobel filter.

47. MATLAB script:

```
function y = lccde(b,a,x)
% P0247: LCCDE stream implementation
% Eq.(2.94)  $y[n] = -\sum_{k=1}^N \{a_k y[n-k]\} + \sum_{k=0}^M \{b_k x[n-k]\}$ 
%% Testing:
% b = [0.18 0.1 0.3 0.1 0.18];
% a = [1 -1.15 1.5 -0.7 0.25];
% [x n] = delta(0,0,59);
%% function:
na = length(a); nb = length(b);
if a(1)~=1
    a = a/a(1);
end
nab = max([na,nb]);
nx = length(x);
x = [zeros(1,nab-1),x(:)'];
y = zeros(1,nx+nab-1);
for ii = nab:nx+nab-1
    y(ii) = b(1)*x(ii);
    for jj = 2:nab
        y(ii) = y(ii)-a(jj)*y(ii-jj+1)+b(jj)*x(ii-jj+1);
    end
end
y = y(end-nx+1:end);
```

48. Solution:

$$\begin{aligned} y(t) &= h(t) * x(t) = \int_{-\infty}^{\infty} h(\tau)x(t-\tau)d\tau \\ &= \int_{-\infty}^{\infty} [u(\tau) - u(\tau-3)][u(t-\tau) - u(t-\tau-2)] d\tau \\ &= \int_0^3 [u(t-\tau) - u(t-\tau-2)] d\tau \end{aligned}$$

$$0 \leq t \leq 2, \quad y(t) = \int_0^t 1d\tau = t$$

$$2 \leq t \leq 3, \quad y(t) = \int_{t-2}^t 1d\tau = 2$$

$$3 \leq t \leq 5, \quad y(t) = \int_{t-2}^3 1 d\tau = 5 - t$$

otherwise, $y(t) = 0$.

49. Solution:

$$h(t) = e^{-t/2}u(t), \quad x(t) = x_2(t) = 2, \quad 0 \leq t \leq 3$$

$$y(t) = x(t) * h(t) = \int_{-\infty}^{\infty} h(\tau)x(t - \tau)d\tau$$

$$0 \leq t \leq 3$$

$$y(t) = 2 \int_0^t e^{-\tau/2} d\tau = 4 - 4e^{-t/2}$$

$$t \geq 3$$

$$y(t) = 2 \int_{t-3}^t e^{-\tau/2} d\tau = 4e^{-t/2}(e^{3/2} - 1)$$

$$y(t) = 0, \quad \text{otherwise}$$

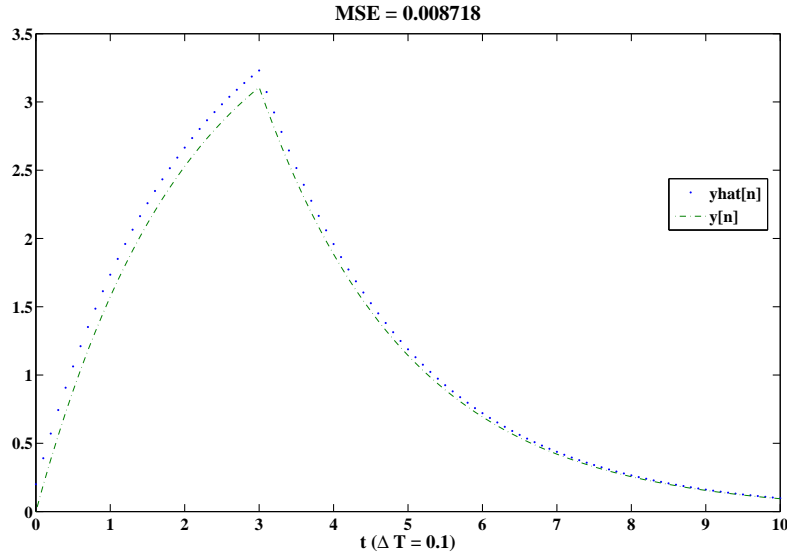
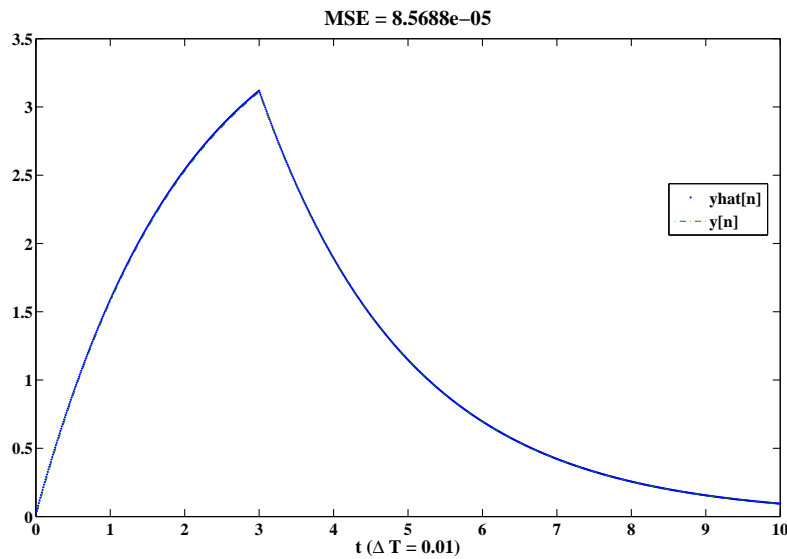

FIGURE 2.65: Plot of sequences $\hat{y}(nT)$ and $y(nT)$ for $T = 0.1$.

MATLAB script:

FIGURE 2.66: Plot of sequences $\hat{y}(nT)$ and $y(nT)$ for $T = 0.01$.

```

% P0249: Compute and plot continuous-time convolution
%         using discrete approximation
close all; clc
% dT = 0.1;
dT = 0.01;
n = 0:10/dT;
t = n*dT;
h = exp(-t/2); % h in P0220
x = zeros(1,length(n));
ind = (t >= 0 & t <=3);
x(ind) = 2; % x2 in P0220
% Theoretical continuous y(t):
y = zeros(1,length(n));
ind = (t >= 0 & t <= 3);
y(ind) = 4-4*exp(-t(ind)/2);
ind = (t >=3);
y(ind) = 4*(exp(1.5)-1)*exp(-t(ind)/2);
% Approximated y(t):
yhat = conv(h,x);

```

```
yhat = dT*yhat;
yhat = yhat(1:length(n));
% Compute mean square error:
mse = mean((y-yhat).^2);
% Plot:
hf1 = figconfg('P0249');
plot(t,yhat,'.',t,y,'-.');
TB = ['MSE = ',num2str(mse)];
title(TB,'fontsize',TFS)
LB = ['t (\Delta T = ',num2str(dT),')'];
xlabel(LB,'fontsize',LFS);
legend('yhat[n]','y[n]','location','best')
```

Review Problems

50. MATLAB script:

```
% P0250: Generate digital reverberation using audio file 'handel'
%           and compare it with the one generated in P0219
close all; clc
load('handel.mat')
[d nd] = delta(0,0,1e3);
n = 1:length(y);
a = 0.7; % specify attenuation factor
tau = 50e-3; % Part (a)
% tau = 100e-3; % Part (b)
% tau = 500e-3; % Part (c)
D = floor(tau*Fs); % compute delay
yir = filter([zeros(1,length(D)) 1],[1 zeros(1,length(D)-1),-a],d);
% Plot:
hf = figconfg('P0250');
plot(nd,yir)
% axis([n(1)-1 n(end)+1 min(y3(1:length(n)))-1 max(y3(1:length(n)))+1])
xlabel('n','fontsize',LFS);
title('Impulse Response','fontsize',LFS)
yd = filter([zeros(1,length(D)) 1],[1 zeros(1,length(D)-1),-a],y);
yd_ref = filter(1,[1 zeros(1,length(D)-1),-a],y);
% sound(y,Fs)
% pause(1)
sound(yd,Fs)
pause(1)
sound(yd_ref,Fs)
```

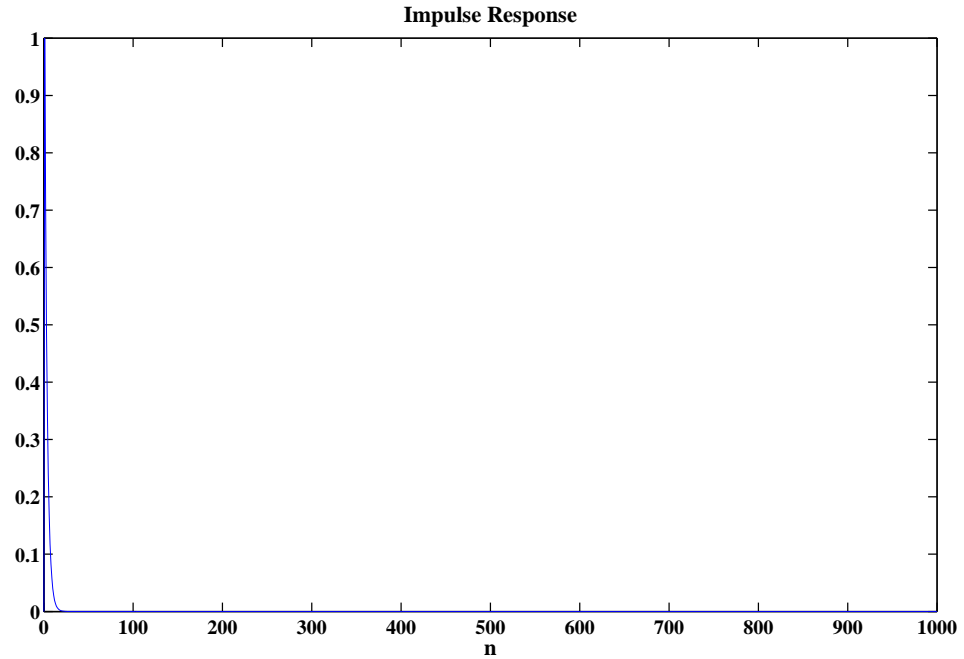
FIGURE 2.67: Impulse response for $a = 0.7$.

51. (a) Solution:

$$\begin{aligned}
 h[n] * g[n] &= \left(\sum_{k=0}^{\infty} a_k \delta[n - kD] \right) * \left(\sum_{l=0}^{\infty} b_l \delta[n - lD] \right) \\
 &= \sum_{k=0}^{\infty} \sum_{l=0}^{\infty} a_k b_l \delta[n - kD] * \delta[n - lD] \\
 &= \sum_{k=0}^{\infty} \sum_{l=0}^{\infty} a_k b_l \delta[n - kD - lD] \\
 &= \sum_{k=0}^{\infty} c_k \delta[n - kD] = \delta[n]
 \end{aligned}$$

Hence, we can conclude

$$\begin{cases} c_0 = a_0 b_0 = 1 \\ c_k = \sum_{m=0}^k a_{k-m} b_m = 0, \quad k > 0 \end{cases}$$

(b) Solution:

$$\begin{cases} c_0 = a_0 b_0 = 1 \\ c_1 = a_0 b_1 + a_1 b_0 = 0 \\ c_2 = a_0 b_2 + a_1 b_1 + a_2 b_0 = 0 \end{cases} \implies \begin{cases} b_0 = a_0^{-1} \\ b_1 = -a_1 a_0^{-2} \\ b_2 = -a_2 a_0^{-2} + a_1^2 a_0^{-3} \end{cases}$$

(c) Solution:

Combined the conditions and the results of previous parts, we have

$$b_k + 0.5b_{k-1} + 0.25b_{k-2} = 0, \quad b_0 = 1, \quad b_1 = -0.5, \quad b_2 = 0$$

k	0	1	2	3	4	5	6	7	...
b_k	1	-0.5	0	0.5^3	-0.5^4	0	0.5^6	-0.5^7	...

We can conclude that

$$b_k = \begin{cases} 0.5^k, & k = 3l \\ -0.5^k, & k = 3l + 1 \\ 0, & k = 3l + 2 \end{cases} \quad l = 0, 1, 2, \dots$$

52. (a) Solution:

$$u[n] = \sum_{k=0}^{\infty} \delta[n-k] = \sum_{k=-\infty}^n \delta[k]$$

$$\begin{aligned} s[n] &= h[n] * u[n] = h[n] * \sum_{k=0}^{\infty} \delta[n-k] = \sum_{k=0}^{\infty} h[n] * \delta[n-k] \\ &= \sum_{k=0}^{\infty} h[n-k] \end{aligned}$$

if $\sum_{k=0}^{\infty} h[n-k] = 0$, for all $n < 0$

$$\left. \begin{aligned} \sum_{k=0}^{\infty} h[-1-k] &= \sum_{k=0}^{\infty} h[-2-k] + h[-1] = 0 \\ \sum_{k=0}^{\infty} h[-2-k] &= 0 \end{aligned} \right\} \implies h[-1] = 0$$

Follow the above procedure, we can prove by mathematical induction that $h[n] = 0$, for all $n < 0$. Hence, we conclude a system is causal if the step response $s[n]$ is zero for $n < 0$.

(b) Solution:

$$y[n] = x[n] * h[n] = \sum_{m=-\infty}^{\infty} h[n-m]x[m]$$

Suppose a period of $h[n]$ is N , that is $h[n + N] = h[n]$.

$$y[n + N] = \sum_{m=-\infty}^{\infty} h[N + n - m]x[m] = \sum_{m=-\infty}^{\infty} h[n - m]x[m] = y[n]$$

Hence, we proved the output is periodic.

- (c) Solution: Wrong. A counter example is the output of the stable system is always zero.
- (d) Solution: Wrong: The inverse of the identity system is itself and it is causal.
- (e) Solution: Wrong. A counter example, $h[n] = (0.5)^n u[n]$, is both of infinite-duration and stable.
- (f) Solution: Wrong. A counter example is $h[n] = u[n]$ which is unstable.
53. (a) Solution:

$$h[n] = \delta[n + 1] - 2\delta[n] + \delta[n - 1]$$

- (b) Comments: The resulting image highlights vertical edges.
- (c) Comments: The resulting image highlights horizontal edges.

MATLAB script:

```
% P0253: Filtering 2D image lena.jpg using 1D second
% derivative filter: y[n] = x[n+1]-2x[n]+x[n-1]
close all; clc
x = imread('lena.jpg');
[nx ny] = size(x);
% Part (b): row processing
hfs = figconf('P0253a','small');
imshow(x, [])
h = [1 -2 1];
y1 = zeros(nx,ny);
for ii = 1:nx
    temp = conv(double(x(ii,:)),h);
    y1(ii,:) = temp(2:end-1);
end
hf1 = figconf('P0253b','small');
imshow(y1, [])
% Part (c): column processing
y2 = zeros(nx,ny);
```

```
for ii = 1:ny
    temp = conv(double(x(:,ii)),h);
    y2(:,ii) = temp(2:end-1);
end
hf2 = figconfg('P0253c','small');
imshow(y2, [])
```



(a)

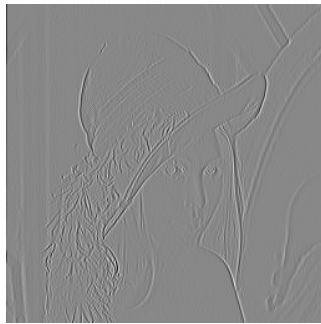

(b)

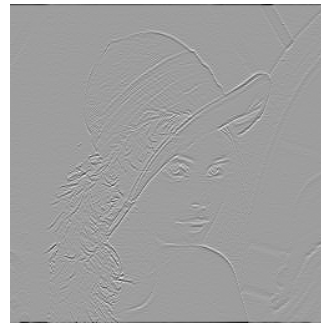

(c)

FIGURE 2.68: (a) Original image. (b) Filtered image after row-by-row processing. (c) Filtered image after column-by-column processing.

54. (a) Comments: The resulting image is about the fine edge details.

(b) Solution:

$$h[m, n] = \begin{bmatrix} 0 & -1 & 0 \\ -1 & 5 & -1 \\ 0 & -1 & 0 \end{bmatrix}$$

(c) Comments: The edge details are enhanced in the resulting image than the original one.

MATLAB script:

```
% P0254: Filtering 2D image lena.jpg using 2D Laplacian filter
%           Illustrating edge enhancement
close all; clc
% Part (a):
x = imread('lena.jpg');
[nx ny] = size(x);
hfs = figconfg('P0254a', 'small');
imshow(x, [])
h = [0 1 0; 1 -4 1; 0 1 0];
y1 = filter2(h, x);
hf1 = figconfg('P0254b', 'small');
imshow(y1, [])
% Part (c):
heh = [0 -1 0; -1 5 -1; 0 -1 0];
y2 = filter2(heh, x);
hf2 = figconfg('P0254c', 'small');
imshow(y2, [])
```



(a)



(b)



(c)

FIGURE 2.69: (a) Original image. (b) Filtered image using the impulse response (2.125). (c) Filtered image using the edge-enhanced filter specified in part (b).